



pietranera[®]
ITALIAN DESIGN & PRODUCTION

HEAD SPA
experience

CATALOGUE 2025

PERFORMANCE DESIGN FOR YOUR SALON

Carsat

Carsat

Carsat

Carsat

Carsat

Carsat

Carsat

INDEX

INDEX

INDEX

INDEX

INDEX



POLTRONE CHAIRS FAUTEUILS STÜHLE

IT LE POLTRONE PIETRANERA SONO APPREZZATE IN TUTTO IL MONDO. TRASFORMANO IL MOMENTO DELLO STYLING IN UNA OCCASIONE DI RELAX. DAL DESIGN ALLE CUCITURE, OGNI DETTAGLIO È CURATO NEI MINIMI PARTICOLARI PER FORNIRE UN'ESPERIENZA CAPACE DI CONIUGARE COMODITÀ ED EFFICIENZA POLTRONE ACCOGLIENTI, ELEGANTI PER UN SALONE IN CUI LA BELLEZZA È PROTAGONISTA.

EN PIETRANERA CHAIRS ARE APPRECIATED ALL OVER THE WORLD. THEY TURN THE STYLING MOMENT INTO AN OPPORTUNITY TO RELAX. FROM DESIGN TO STITCHING, EVERY DETAIL IS PREPARED METICULOUSLY TO PROVIDE AN EXPERIENCE THAT COMBINES COMFORT AND EFFICIENCY. COMFORTABLE, ELEGANT CHAIRS FOR A SALON WHERE BEAUTY IS THE PROTAGONIST.

FR LES FAUTEUILS PIETRANERA SONT APPRÉCIÉS DANS LE MONDE ENTIER. ILS TRANSFORMENT LA SÉANCE DE COIFFURE EN UN MOMENT DE DÉTENTE. DU DESIGN AUX COUTURES, CHAQUE DÉTAIL EST SOIGNÉ DANS LES MOINDRES DÉTAILS AFIN DE FOURNIR UNE EXPÉRIENCE QUI SAURA MARIER CONFORT ET EFFICACITÉ. DES FAUTEUILS ACCUEILLANTS, ÉLÉGANTS, POUR UN SALON OÙ C'EST LA BEAUTÉ QUI EST AU CENTRE.

DE PIETRANERA-SESSEL STOSSEN WELTWEIT AUF GROSSEN ANKLANG. MIT IHNEN WIRD JEDER MOMENT DES STYLINGS ZU EINER GELEGENHEIT ZUR ENTSPANNUNG. VOM DESIGN BIS ZUR VERARBEITUNG WIRD AUF JEDES DETAIL GEACHTET, UM EIN ERLEBNIS ZU BIETEN, DAS KOMFORT UND EFFIZIENZ VEREINT. GEMÜTLICHE, ELEGANTE SESSEL FÜR EINEN SALON, IN DEM DIE SCHÖNHEIT DIE HAUPTROLLE SPIELT.





AMELIA

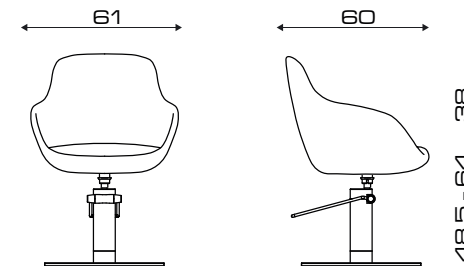

- VERSIONI
- MODELS
- VERSIONS
- VERSIONEN

- GIREVOLE
- SWIVEL
- TOURNANT
- DREHBAR

- IDRAULICA BLOC. 2 ANNI GARANZIA
- LOCKABLE PUMP 2 YEARS WARR.
- HYDR. AVEC BLOC.GARANTIE 2 ANS
- ARRETIERBARE PUMPE GARANTIE 2 JAHREN

- ACCESSORI
- ACCESSORIES
- ACCESSOIRES
- ZUBEHÖR



COD. 121.3R

COD. 121.8R



COD. 121.16L

COD. 121.17L



COD. 121.55

COD. 121.57

COD. SPECIAL

- SKAI SPECIAL
- SKAI SPECIAL
- SKAI SPECIAL
- SKAI SPECIAL

COD. M0/121

- FODERINA SCHIENALE
- BACKREST COVER
- HOUSSE DE PROTECTION DOSSIER
- SCHUTZHÜLLE FÜR RÜCKENLEHNE AUS PVC

COD. 43

- POGGIAPIEDI SOLO CON POMPA FRENO
- FOOTREST FOR PUMP ONLY
- REPOSE-PIEDS POUR PIÈTEMENT AVEC BLOCAGE
- FUßSTÜTZE (NUR MIT ARRETIERBARE PUMPE)

- SUPPLEMENTO POMPA 5 ANNI GARANZIA
- SURCHARGE 5 YEARS PUMP WARRANTY
- SUPPLÉMENT POMPE 5 GARANTIE 5 ANS
- ZUSCHLAG FÜR PUMPE MIT 5 JAHREN GARANTIE

BLADE EASY

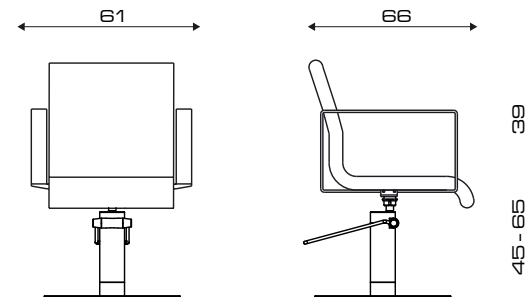

- BRACCIOLI IMBOTTITI
- PADDED ARMRESTS
- ACCOUDOIRS REMBOURRÉS
- GEPOLSTERTE ARMLEHNEN

- VERSIONI
- MODELS
- VERSIONS
- VERSIONEN
- GIREVOLE
- SWIVEL
- TOURNANT
- DREHBAR
- IDRAULICA BLOC. 2 ANNI GARANZIA
- LOCKABLE PUMP 2 YEARS WARR.
- HYDR. AVEC BLOC. GARANTIE 2 ANS
- ARRETIERBARE PUMPE GARANTIE 2 JAHREN

- ACCESSORI
- ACCESSORIES
- ACCESSOIRES
- ZUBEHÖR



COD. 69A.3R

COD. 69A.8R



COD. 69A.16L

COD. 69A.17L



COD. 69A.55

COD. 69A.57

COD. SPECIAL

- SKAI SPECIAL
- SKAI SPECIAL
- SKAI SPÉCIAL
- SKAI SPECIAL

COD. M0/69

- FODERINA SCHIENALE
- BACKREST COVER
- HOUSSE DE PROTECTION DOSSIER
- SCHUTZHÜLLE FÜR RÜCKENLEHNE AUS PVC

COD. 148

- POGGIATESTA
- HEADREST
- REPOSE-TÊTE
- KOPFSTÜTZE

COD. BRACC.

- BRACCIOLI IMBOTTITI
- PADDED ARMREST
- ACCOUDOIRS REMBOURRÉS EN SKAI
- GEPOLSTERTE ARMLEHNEN

COD. 43

- POGGIAPIEDI SOLO CON POMPA FRENO
- FOOTREST FOR PUMP ONLY
- REPOSE-PIEDS POUR PIÈTEMENT AVEC BLOCAGE
- FUSSTÜTZE (NUR MIT ARRETIERBARE PUMPE)

- SUPPLEMENTO POMPA 5 ANNI GARANZIA
- SURCHARGE 5 YEARS PUMP WARRANTY
- SUPPLÉMENT POMPE 5 GARANTIE 5 ANS
- ZUSCHLAG FÜR PUMPE 5 JAHREN GARANTIE

BOLERO

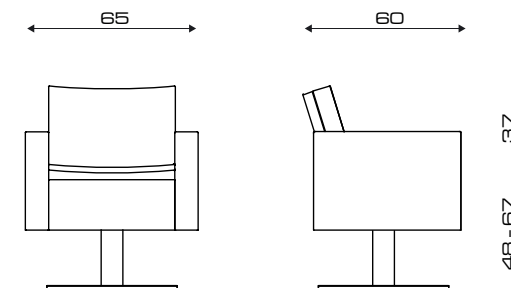

- VERSIONI
- MODELS
- VERSIONS
- VERSIONEN
- GIREVOLE
- SWIVEL
- TOURNANT
- DREHBAR

- IDRAULICA BLOC. 2 ANNI GARANZIA
- LOCKABLE PUMP 2 YEARS WARR.
- HYDR. AVEC BLOC.GARANTIE 2 ANS
- ARRETIERBARE PUMPE GARANTIE 2 JAHREN

- ACCESSORI
- ACCESSORIES
- ACCESSOIRES
- ZUBEHÖR



COD. 110.3R

COD. 110.8R



COD. 110.16L

COD. 110.17L



COD. 110.55

COD. 110.57

COD. SPECIAL

- SKAI SPECIAL
- SKAI SPECIAL
- SKAI SPÉCIAL
- SKAI SPECIAL

COD. M0/110

- FODERINA SCHIENALE
- BACKREST COVER
- HOUSSE DE PROTECTION DOSSIER
- SCHUTZHÜLLE FÜR RÜCKENLEHNE AUS PVC

COD. 148

- POGGIATESTA
- HEADREST
- REPOSE-TÊTE
- KOPFSTÜTZE

COD. 43

- POGGIAPIEDI SOLO CON POMPA FRENO
- FOOTREST FOR PUMP ONLY
- REPOSE-PIEDS POUR PIÈTEMENT AVEC BLOCAGE
- FUßSTÜTZE (NUR MIT ARRETIERBARE PUMPE)

- SUPPLEMENTO POMPA 5 ANNI GARANZIA
- SURCHARGE 5 YEARS PUMP WARRANTY
- SUPPLÉMENT POMPE 5 GARANTIE 5 ANS
- ZUSCHLAG FÜR PUMPE 5 JAHREN GARANTIE

BOLERO OPTIMA

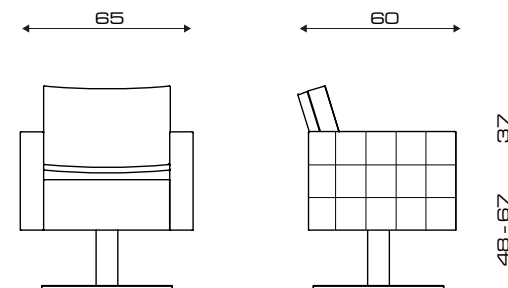

- VERSIONI
- MODELS
- VERSIONS
- VERSIONEN
- GIREVOLE
- SWIVEL
- TOURNANT
- DREHBAR
- IDRAULICA BLOC. 5 ANNI GARANZIA
- LOCKABLE PUMP 5 YEARS WARR.
- HYDR. AVEC BLOC.GARANTIE 5 ANS
- ARRETIERBARE PUMPE GARANTIE 5 JAHREN

- ACCESSORI
- ACCESSORIES
- ACCESSOIRES
- ZUBEHÖR



COD. 110B.3R

COD. 110B.7R



COD. 110B.16L

COD. 110B.19L



COD. 110B.55

COD. 110B.56

COD. SPECIAL

- SKAI SPECIAL
- SKAI SPECIAL
- SKAI SPÉCIAL
- SKAI SPECIAL

COD. M0/110B

- FODERINA SCHIENALE
- BACKREST COVER
- HOUSSE DE PROTECTION DOSSIER
- SCHUTZHÜLLE FÜR RÜCKENLEHNE AUS PVC

COD. 43

- POGGIAPIEDI SOLO CON POMPA FRENO
- FOOTREST FOR PUMP ONLY
- REPOSE-PIEDS POUR PIÈTEMENT AVEC BLOCAGE
- FUSSSTÜTZE (NUR MIT ARRETIERBARE PUMPE)

- PER POMPA 2 ANNI GARANZIA, DETRARRE
- FOR 2 YEARS PUMP WARRANTY, DEDUCT
- POUR POMPE GARANTIE 2 ANS, DÉDUIRE
- FÜR PUMPE 2 JAHREN GARANTIE, ABZIEHEN

COBRA METAL

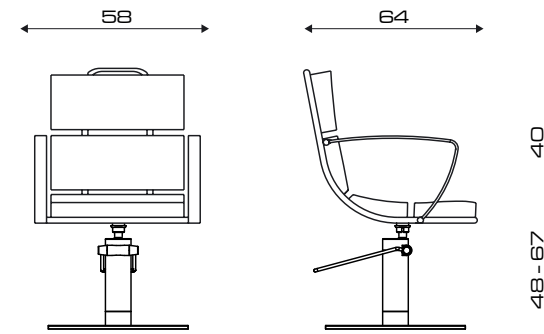

- VERSIONI
- MODELS
- VERSIONS
- VERSIONEN
- GIREVOLE
- SWIVEL
- TOURNANT
- DREHBAR

- IDRAULICA BLOC. 2 ANNI GARANZIA
- LOCKABLE PUMP 2 YEARS WARR.
- HYDR. AVEC BLOC.GARANTIE 2 ANS
- ARRETIERBARE PUMPE GARANTIE 2 JAHREN

- ACCESSORI
- ACCESSORIES
- ACCESSOIRES
- ZUBEHÖR



COD. 66.3R

COD. 66.8R



COD. 66.16L

COD. 66.17L



COD. 66.55

COD. 66.57

COD. SPECIAL

- SKAI SPECIAL
- SKAI SPECIAL
- SKAI SPÉCIAL
- SKAI SPECIAL

COD. M0/66

- FODERINA SCHIENALE
- BACKREST COVER
- HOUSSE DE PROTECTION DOSSIER
- SCHUTZHÜLLE FÜR RÜCKENLEHNE AUS PVC

COD. 154

- POGGIATESTA
- HEADREST
- REPOSE-TÊTE
- KOPFSTÜTZE

COD. 43

- POGGIAPIEDI SOLO CON POMPA FRENO
- FOOTREST FOR PUMP ONLY
- REPOSE-PIEDS POUR PIÈTEMENT AVEC BLOCAGE
- FUSSSTÜTZE (NUR MIT ARRETIERBARE PUMPE)

- SUPPLEMENTO POMPA 5 ANNI GARANZIA
- SURCHARGE 5 YEARS PUMP WARRANTY
- SUPPLÉMENT POMPE 5 GARANTIE 5 ANS
- ZUSCHLAG FÜR PUMPE 5 JAHREN GARANTIE

LITZ

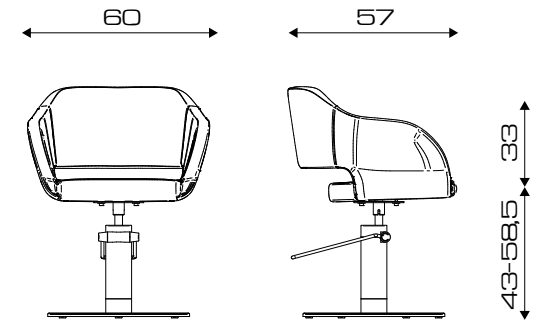

- VERSIONI
- MODELS
- VERSIONS
- VERSIONEN
- GIREVOLE
- SWIVEL
- TOURNANT
- DREHBAR

- IDRAULICA BLOC. 2 ANNI GARANZIA
- LOCKABLE PUMP 2 YEARS WARR.
- HYDR. AVEC BLOC.GARANTIE 2 ANS
- ARRETIERBARE PUMPE GARANTIE 2 JAHREN

- ACCESSORI
- ACCESSORIES
- ACCESSOIRES
- ZUBEHÖR



COD. 25.3R

COD. 25.8R



COD. 25.16L

COD. 25.17L

COD. SPECIAL

- SKAI SPECIAL
- SKAI SPÉCIAL
- SKAI SPÉCIAL
- SKAI SPECIAL

COD. M0/25

- FODERINA SCHIENALE
- BACKREST COVER
- HOUSSE DE PROTECTION DOSSIER
- SCHUTZHÜLLE FÜR RÜCKENLEHNE AUS PVC

COD. 43

- POGGIAPIEDI SOLO CON POMPA FRENO
- FOOTREST FOR PUMP ONLY
- REPOSE-PIEDS POUR PIÈTEMENT AVEC BLOCAGE
- FUSSSTÜTZE (NUR MIT ARRETIERBARE PUMPE)

- SUPPLEMENTO POMPA 5 ANNI GARANZIA
- SURCHARGE 5 YEARS PUMP WARRANTY
- SUPPLÉMENT POMPE 5 GARANTIE 5 ANS
- ZUSCHLAG FÜR PUMPE 5 JAHREN GARANTIE

COCÒ ESSENTIAL

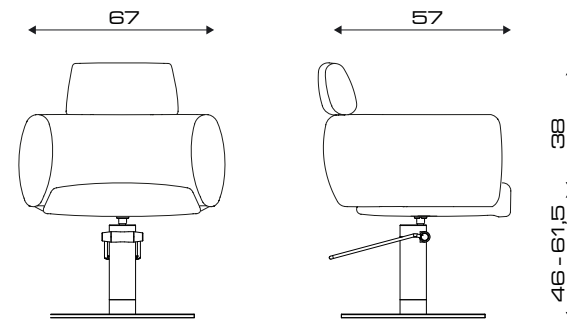

- VERSIONI
- MODELS
- VERSIONS
- VERSIONEN

- GIREVOLE
- SWIVEL
- TOURNANT
- DREHBAR

- IDRAULICA BLOC. 2 ANNI GARANZIA
- LOCKABLE PUMP 2 YEARS WARR.
- HYDR. AVEC BLOC.GARANTIE 2 ANS
- ARRETIERBARE PUMPE GARANTIE 2 JAHREN

- ACCESSORI
- ACCESSORIES
- ACCESSOIRES
- ZUBEHÖR



COD. 106.3R

COD. 106.8R

COD. SPECIAL

- SKAI SPECIAL
- SKAI SPÉCIAL
- SKAI SPÉCIAL
- SKAI SPECIAL

- SUPPLEMENTO POMPA 5 ANNI GARANZIA
- SURCHARGE 5 YEARS PUMP WARRANTY
- SUPPLÉMENT POMPE 5 GARANTIE 5 ANS
- ZUSCHLAG FÜR PUMPE 5 JAHREN GARANTIE



COD. 106.16L

COD. 106.17L

COD. 43

- POGGIAPIEDI SOLO CON POMPA FRENO
- FOOTREST FOR PUMP ONLY
- REPOSE-PIEDS POUR PIÈTEMENT AVEC BLOCAGE
- FUSSSTÜTZE (NUR MIT ARRETIERBARE PUMPE)

COCÒ ESSENTIAL LIFT

Carsat

NEWS

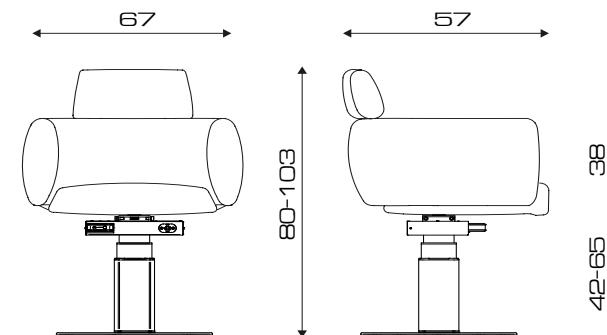

COD. 106.60E + POG

- BASE GIREVOLE ELETTRICA A BATTERIA CON COMANDO A PEDALE WIRELESS.
- BATTERY-ELECTRIC SWIVEL BASE WITH WIRELESS FOOT CONTROL.
- BASE PIVOTANTE ÉLECTRIQUE ALIMENTÉE PAR BATTERIE AVEC COMMANDE AU PIED SANS FIL.
- BATTERIEBETRIEBENER ELEKTRISCHER DREHFUSS MIT KABELLOSER FUßSTEUERUNG.

- VERSIONI
- MODELS
- VERSIONS
- VERSIONEN

- ACCESSORI
- ACCESSORIES
- ACCESSOIRES
- ZUBEHÖR

COD. 106.60E

COD. SPECIAL

- SKAI SPECIAL
- SKAI SPÉCIAL
- SKAI SPÉCIAL
- SKAI SPECIAL

COD. POG

- POGGIAPIEDI.
- FOOTREST.
- REPOSE-PIEDS.
- FUSSTÜTZE.

FIFTY

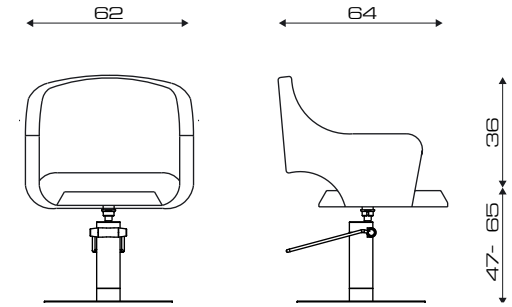

- VERSIONI
- MODELS
- VERSIONS
- VERSIONEN
- GIREVOLE
- SWIVEL
- TOURNANT
- DREHBAR

- IDRAULICA BLOC. 2 ANNI GARANZIA
- LOCKABLE PUMP 2 YEARS WARR.
- HYDR. AVEC BLOC.GARANTIE 2 ANS
- ARRETIERBARE PUMPE GARANTIE 2 JAHREN

- ACCESSORI
- ACCESSORIES
- ACCESSOIRES
- ZUBEHÖR



COD. 59.3R

COD. 59.8R



COD. 59.16L

COD. 59.17L



COD. 59.55

COD. 59.57

COD. SPECIAL

- SKAI SPECIAL
- SKAI SPECIAL
- SKAI SPÉCIAL
- SKAI SPECIAL

COD. M0/59

- FODERINA SCHIENALE
- BACKREST COVER
- HOUSSE DE PROTECTION DOSSIER
- SCHUTZHÜLLE FÜR RÜCKENLEHNE AUS PVC

COD. 154

- POGGIATESTA
- HEADREST
- REPOSE-TÊTE
- KOPFSTÜTZE

COD. 43

- POGGIAPIEDI (SOLO PER POMPA IDR. BLOC.)
- FOOTREST (ONLY WITH LOCKALE PUMP)
- REPOSE-PIEDS (POUR PIÈTEMENT AVEC BLOC.)
- FUSSSTÜTZE (NUR MIT ARRETIERBARE PUMPE)

- SUPPLEMENTO POMPA 5 ANNI GARANZIA
- SURCHARGE 5 YEARS PUMP WARRANTY
- SUPPLÉMENT POMPE 5 GARANTIE 5 ANS
- ZUSCHLAG FÜR PUMPE 5 JAHREN GARANTIE

FIFTY LIFT

Carsat

NEWS

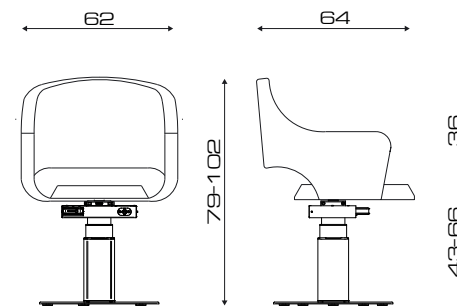

•BASE GIREVOLE ELETTRICA A BATTERIA CON COMANDO A PEDALE WIRELESS.

•BATTERY-ELECTRIC SWIVEL BASE WITH WIRELESS FOOT CONTROL.

•BASE PIVOTANTE ÉLECTRIQUE ALIMENTÉE PAR BATTERIE AVEC COMMANDE AU PIED SANS FIL.

•BATTERIEBETRIEBENER ELEKTRISCHER DREHFUSS MIT KABELLOSER FUßSTEUERUNG.

•VERSIONI
•MODELS
•VERSIONS
•VERSIONEN

•ACCESSORI
•ACCESSORIES
•ACCESSOIRES
•ZUBEHÖR

COD. 59.60E + POG

COD. 59.60E

COD. SPECIAL

•SKAI SPECIAL
•SKAI SPECIAL
•SKAI SPÉCIAL
•SKAI SPECIAL

COD. M0/59

•FODERINA SCHIENALE
•BACKREST COVER
•HOUSSE DE PROTECTION DOSSIER
•SCHUTZHÜLLE FÜR RÜCKENLEHNE AUS PVC

COD. 154

•POGGIATESTA
•HEADREST
•REPOSE-TÊTE
•KOPFSTÜTZE

COD. POG

•POGGIAPIEDI
•FOOTREST
•REPOSE-PIEDS
•FUSSSTÜTZE

JOLIE

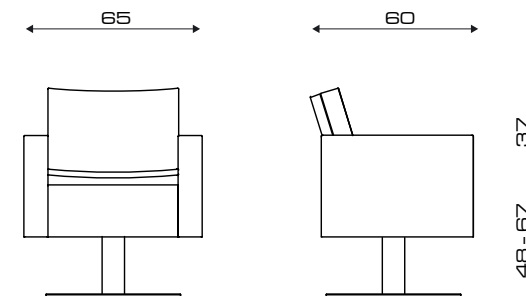

- VERSIONI
- MODELS
- VERSIONS
- VERSIONEN
- GIREVOLE
- SWIVEL
- TOURNANT
- DREHBAR

- IDRAULICA BLOC. 2 ANNI GARANZIA
- LOCKABLE PUMP 2 YEARS WARR.
- HYDR. AVEC BLOC.GARANTIE 2 ANS
- ARRETIERBARE PUMPE GARANTIE 2 JAHREN

- ACCESSORI
- ACCESSORIES
- ACCESSOIRES
- ZUBEHÖR



COD. 28.3R

COD. 28.8R



COD. 28.16L

COD. 28.17L



COD. 28.55

COD. 28.57

COD. SPECIAL

- SKAI SPECIAL
- SKAI SPECIAL
- SKAI SPÉCIAL
- SKAI SPECIAL

COD. M0/28

- FODERINA SCHIENALE
- BACKREST COVER
- HOUSSE DE PROTECTION DOSSIER
- SCHUTZHÜLLE FÜR RÜCKENLEHNE AUS PVC

COD. 148

- POGGIATESTA
- HEADREST
- REPOSE-TÊTE
- KOPFSTÜTZE

COD. 43

- POGGIAPIEDI (SOLO PER POMPA IDR. BLOC.)
- FOOTREST (ONLY WITH LOCKALE PUMP)
- REPOSE-PIEDS (POUR PIÈTEMENT AVEC BLOC.)
- FUSSSTÜTZE (NUR MIT ARRETIERBARE PUMPE)

- SUPPLEMENTO POMPA 5 ANNI GARANZIA
- SURCHARGE 5 YEARS PUMP WARRANTY
- SUPPLÉMENT POMPE 5 GARANTIE 5 ANS
- ZUSCHLAG FÜR PUMPE 5 JAHREN GARANTIE

ZONE

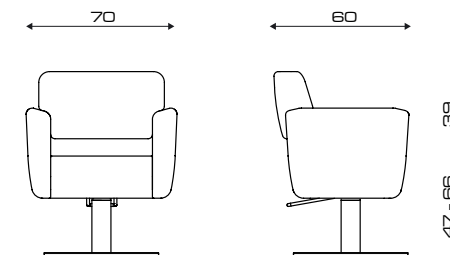

- VERSIONI
- MODELS
- VERSIONS
- VERSIONEN
- GIREVOLE
- SWIVEL
- TOURNANT
- DREHBAR

- IDRAULICA BLOC. 5 ANNI GARANZIA
- LOCKABLE PUMP 5 YEARS WARR.
- HYDR. AVEC BLOC.GARANTIE 5 ANS
- ARRETIERBARE PUMPE GARANTIE 5 JAHREN

- ACCESSORI
- ACCESSORIES
- ACCESSOIRES
- ZUBEHÖR



COD. 114.16L

COD. 114.19L



COD. 114.55

COD. 114.56

COD. SPECIAL

- SKAI SPECIAL
- SKAI SPÉCIAL
- SKAI SPÉCIAL
- SKAI SPECIAL

COD. M0/114

- FODERINA SCHIENALE
- BACKREST COVER
- HOUSSE DE PROTECTION DOSSIER
- SCHUTZHÜLLE FÜR RÜCKENLEHNE AUS PVC

COD. 43

- POGGIAPIEDI (SOLO PER POMPA IDR. BLOC.)
- FOOTREST (ONLY WITH LOCKABLE PUMP)
- REPOSE-PIEDS (POUR PIÈTEMENT AVEC BLOC.)
- FUSSSTÜTZE (NUR MIT ARRETIERBARE PUMPE)

- PER POMPA 2 ANNI GARANZIA, DETRARRE
- FOR 2 YEARS PUMP WARRANTY, DEDUCT
- POUR POMPE GARANTIE 2 ANS, DÉDUIRE
- FÜR PUMPE 2 JAHREN GARANTIE, ABZIEHEN

KELLY

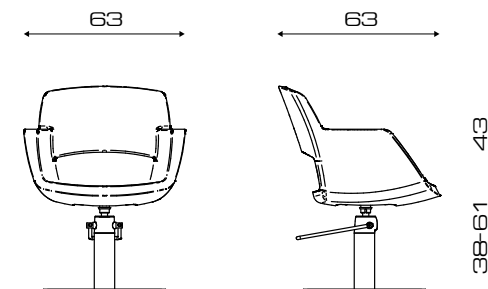

- VERSIONI
- MODELS
- VERSIONS
- VERSIONEN
- GIREVOLE
- SWIVEL
- TOURNANT
- DREHBAR

- IDRAULICA BLOC. 2 ANNI GARANZIA
- LOCKABLE PUMP 2 YEARS WARR.
- HYDR. AVEC BLOC.GARANTIE 2 ANS
- ARRETIERBARE PUMPE GARANTIE 2 JAHREN

- ACCESSORI
- ACCESSORIES
- ACCESSOIRES
- ZUBEHÖR



COD. 20.3R

COD. 20.8R



COD. 20.16L

COD. 20.17L



COD. 20.55

COD. 20.57

COD. SPECIAL

- SKAI SPECIAL
- SKAI SPÉCIAL
- SKAI SPÉCIAL
- SKAI SPECIAL

COD. M0/20

- FODERINA SCHIENALE
- BACKREST COVER
- HOUSSE DE PROTECTION DOSSIER
- SCHUTZHÜLLE FÜR RÜCKENLEHNE AUS PVC

COD. 43

- POGGIAPIEDI (SOLO PER POMPA IDR. BLOC.)
- FOOTREST (ONLY WITH LOCKALE PUMP)
- REPOSE-PIEDS (POUR PIÈTEMENT AVEC BLOC.)
- FUSSSTÜTZE (NUR MIT ARRETIERBARE PUMPE)

- SUPPLEMENTO POMPA 5 ANNI GARANZIA
- SURCHARGE 5 YEARS PUMP WARRANTY
- SUPPLÉMENT POMPE 5 GARANTIE 5 ANS
- ZUSCHLAG FÜR PUMPE 5 JAHREN GARANTIE

KELLY LIFT

Carsat

NEWS

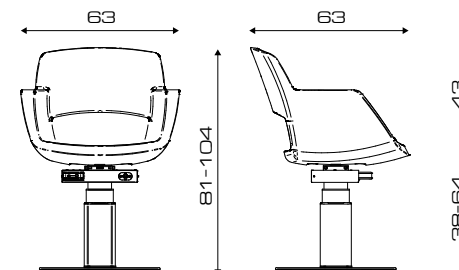

- BASE GIREVOLE ELETTRICA A BATTERIA CON COMANDO A PEDALE WIRELESS.
- BATTERY-ELECTRIC SWIVEL BASE WITH WIRELESS FOOT CONTROL.

- BASE PIVOTANTE ÉLECTRIQUE ALIMENTÉE PAR BATTERIE AVEC COMMANDE AU PIED SANS FIL.
- BATTERIEBETRIEBENER ELEKTRISCHER DREHFUSS MIT KABELLOSER FUßSTEUERUNG.

- VERSIONI
- MODELS
- VERSIONS
- VERSIONEN

- ACCESSORI
- ACCESSORIES
- ACCESSOIRES
- ZUBEHÖR

COD. 20.60E + POG

COD. 20.60E

COD. SPECIAL

- SKAI SPECIAL
- SKAI SPÉCIAL
- SKAI SPÉCIAL
- SKAI SPECIAL

COD. M0/20

- FODERINA SCHIENALE
- BACKREST COVER
- HOUSSE DE PROTECTION DOSSIER
- SCHUTZHÜLLE FÜR RÜCKENLEHNE AUS PVC

COD. POG

- POGGIAPIEDI (SOLO PER POMPA IDR. BLOC.)
- FOOTREST (ONLY WITH LOCKABLE PUMP)
- REPOSE-PIEDS (POUR PIÈTEMENT AVEC BLOC.)
- FUSSTÜTZE (NUR MIT ARRETIERBARE PUMPE)

KIKI

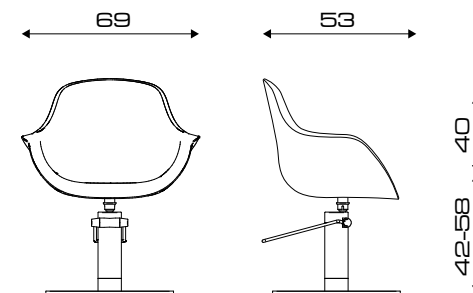

- VERSIONI
- MODELS
- VERSIONS
- VERSIONEN
- GIREVOLE
- SWIVEL
- TOURNANT
- DREHBAR

- IDRAULICA BLOC. 2 ANNI GARANZIA
- LOCKABLE PUMP 2 YEARS WARR.
- HYDR. AVEC BLOC.GARANTIE 2 ANS
- ARRETIERBARE PUMPE GARANTIE 2 JAHREN

- ACCESSORI
- ACCESSORIES
- ACCESSOIRES
- ZUBEHÖR



COD. 30.3R

COD. 30.8R

COD. SPECIAL

- SKAI SPECIAL
- SKAI SPÉCIAL
- SKAI SPÉCIAL
- SKAI SPECIAL

COD. 43

- POGGIAPIEDI (SOLO PER POMPA IDR. BLOC.)
- FOOTREST (ONLY WITH LOCKABLE PUMP)
- REPOSE-PIEDS (POUR PIÈTEMENT AVEC BLOC.)
- FUSSSTÜTZE (NUR MIT ARRETIERBARE PUMPE)



COD. 30.16L

COD. 30.17L

COD. M0/30

- FODERINA SCHIENALE
- BACKREST COVER
- HOUSSE DE PROTECTION DOSSIER
- SCHUTZHÜLLE FÜR RÜCKENLEHNE AUS PVC

- SUPPLEMENTO POMPA 5 ANNI GARANZIA
- SURCHARGE 5 YEARS PUMP WARRANTY
- SUPPLÉMENT POMPE 5 GARANTIE 5 ANS
- ZUSCHLAG FÜR PUMPE 5 JAHREN GARANTIE

LONDRA EASY

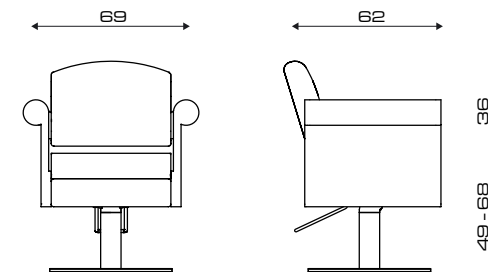

- VERSIONI
- MODELS
- VERSIONS
- VERSIONEN
- GIREVOLE
- SWIVEL
- TOURNANT
- DREHBAR
- IDRAULICA BLOC. 5 ANNI GARANZIA
- LOCKABLE PUMP 5 YEARS WARR.
- HYDR. AVEC BLOC.GARANTIE 5 ANS
- ARRETIERBARE PUMPE GARANTIE 5 JAHREN

- ACCESSORI
- ACCESSORIES
- ACCESSOIRES
- ZUBEHÖR



COD. 115.3R

COD. 115.7R



COD. 115.16L

COD. 115.19L



COD. 115.55

COD. 115.56

COD. SPECIAL

- SKAI SPECIAL
- SKAI SPECIAL
- SKAI SPECIAL
- SKAI SPECIAL

COD. M0/115

- FODERINA SCHIENALE
- BACKREST COVER
- HOUSSE DE PROTECTION DOSSIER
- SCHUTZHÜLLE FÜR RÜCKENLEHNE AUS PVC

COD. 43

- POGGIAPIEDI (SOLO PER POMPA IDR. BLOC.)
- FOOTREST (ONLY WITH LOCKABLE PUMP)
- REPOSE-PIEDS (POUR PIÈTEMENT AVEC BLOC.)
- FUSSSTÜTZE (NUR MIT ARRETIERBARE PUMPE)

- PER POMPA 2 ANNI GARANZIA, DETRARRE
- FOR 2 YEARS PUMP WARRANTY, DEDUCT
- POUR POMPE GARANTIE 2 ANS, DÉDUIRE
- FÜR PUMPE 2 JAHREN GARANTIE, ABZIEHEN

LONDRA MID

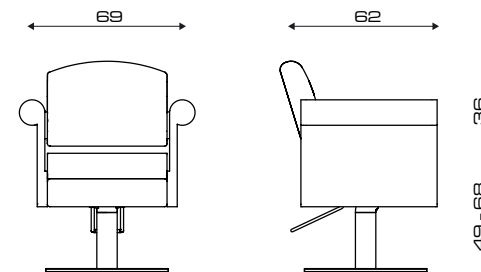

- VERSIONI
- MODELS
- VERSIONS
- VERSIONEN
- GIREVOLE
- SWIVEL
- TOURNANT
- DREHBAR
- IDRAULICA BLOC. 5 ANNI GARANZIA
- LOCKABLE PUMP 5 YEARS WARR.
- HYDR. AVEC BLOC.GARANTIE 5 ANS
- ARRETIERBARE PUMPE GARANTIE 5 JAHREN

- ACCESSORI
- ACCESSORIES
- ACCESSOIRES
- ZUBEHÖR



COD. 115M.3R

COD. 115M.7R



COD. 115M.16L

COD. 115M.19L



COD. 115M.55

COD. 115M.56

COD. SPECIAL

- SKAI SPECIAL
- SKAI SPÉCIAL
- SKAI SPÉCIAL
- SKAI SPECIAL

COD. M0/115B

- FODERINA SCHIENALE
- BACKREST COVER
- HOUSSE DE PROTECTION DOSSIER
- SCHUTZHÜLLE FÜR RÜCKENLEHNE AUS PVC

COD. 43

- POGGIAPIEDI (SOLO PER POMPA IDR. BLOC.)
- FOOTREST (ONLY WITH LOCKABLE PUMP)
- REPOSE-PIEDS (POUR PIÈTEMENT AVEC BLOC.)
- FUSSSTÜTZE (NUR MIT ARRETIERBARE PUMPE)

- PER POMPA 2 ANNI GARANZIA, DETRARRE
- FOR 2 YEARS PUMP WARRANTY, DEDUCT
- POUR POMPE GARANTIE 2 ANS, DÉDUIRE
- FÜR PUMPE 2 JAHREN GARANTIE, ABZIEHEN

LONDRA OPTIMA

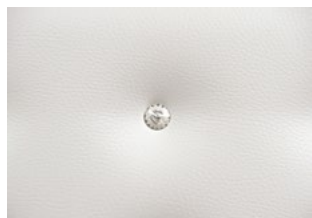

COD. FIN.DIAMOND

BOTTONI EFFETTO DIAMANTE
 BUTTONS "DIAMONDS" EFFECT
 BOUTONS EFFET "DIAMANTS"
 DIAMANT EFFEKT TASTEN

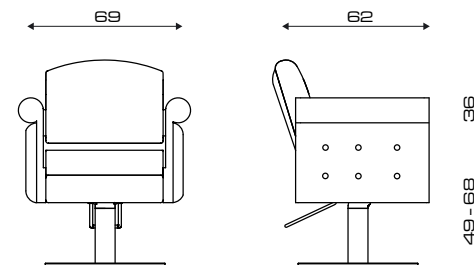

- VERSIONI
- MODELS
- VERSIONS
- VERSIONEN
- GIREVOLE
- SWIVEL
- TOURNANT
- DREHBAR
- IDRAULICA BLOC. 5 ANNI GARANZIA
- LOCKABLE PUMP 5 YEARS WARR.
- HYDR. AVEC BLOC.GARANTIE 5 ANS
- ARRETIERBARE PUMPE GARANTIE 5 JAHREN

- ACCESSORI
- ACCESSORIES
- ACCESSOIRES
- ZUBEHÖR



COD. 115B.3R

COD. 115B.7R



COD. 115B.16L

COD. 115B.19L



COD. 115B.55

COD. 115B.56

COD. SPECIAL

- SKAI SPECIAL
- SKAI SPECIAL
- SKAI SPÉCIAL
- SKAI SPECIAL

COD. M0/115B

- FODERINA SCHIENALE
- BACKREST COVER
- HOUSSE DE PROTECTION DOSSIER
- SCHUTZHÜLLE FÜR RÜCKENLEHNE AUS PVC

COD. FIN.DIAMOND

- FINITURA CON BOTTONI EFFETTO DIAMANTE
- BUTTONS "DIAMONDS" EFFECT
- BOUTONS EFFET "DIAMANTS"
- DIAMANT EFFEKT TASTEN

COD. 43

- POGGIAPIEDI (SOLO PER POMPA IDR. BLOC.)
- FOOTREST (ONLY WITH LOCKABLE PUMP)
- REPOSE-PIEDS (POUR PIÈTEMENT AVEC BLOC.)
- FUSSSTÜTZE (NUR MIT ARRETIERBARE PUMPE)

- PER POMPA 2 ANNI GARANZIA, DETRARRE
- FOR 2 YEARS PUMP WARRANTY, DEDUCT
- POUR POMPE GARANTIE 2 ANS, DÉDUIRE
- FÜR PUMPE 2 JAHREN GARANTIE, ABZIEHEN

MYRA

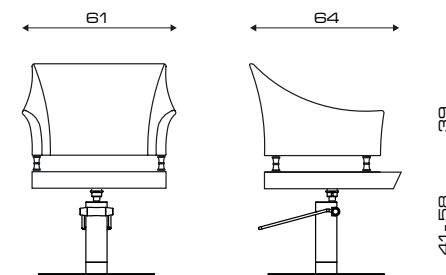

- VERSIONI
- MODELS
- VERSIONS
- VERSIONEN
- GIREVOLE
- SWIVEL
- TOURNANT
- DREHBAR

- IDRAULICA BLOC. 2 ANNI GARANZIA
- LOCKABLE PUMP 2 YEARS WARR.
- HYDR. AVEC BLOC.GARANTIE 2 ANS
- ARRETIERBARE PUMPE GARANTIE 2 JAHREN

- ACCESSORI
- ACCESSORIES
- ACCESSOIRES
- ZUBEHÖR



COD. 41.3R

COD. 41.8R



COD. 41.16L

COD. 41.17L



COD. 41.55

COD. 41.57

COD. SPECIAL

- SKAI SPECIAL
- SKAI SPÉCIAL
- SKAI SPÉCIAL
- SKAI SPECIAL

COD. M0/41

- FODERINA SCHIENALE
- BACKREST COVER
- HOUSSE DE PROTECTION DOSSIER
- SCHUTZHÜLLE FÜR RÜCKENLEHNE AUS PVC

COD. 43

- POGGIAPIEDI (SOLO PER POMPA IDR. BLOC.)
- FOOTREST (ONLY WITH LOCKABLE PUMP)
- REPOSE-PIEDS (POUR PIÈTEMENT AVEC BLOC.)
- FUSSSTÜTZE (NUR MIT ARRETIERBARE PUMPE)

- SUPPLEMENTO POMPA 5 ANNI GARANZIA
- SURCHARGE 5 YEARS PUMP WARRANTY
- SUPPLÉMENT POMPE 5 GARANTIE 5 ANS
- ZUSCHLAG FÜR PUMPE 5 JAHREN GARANTIE

MOR

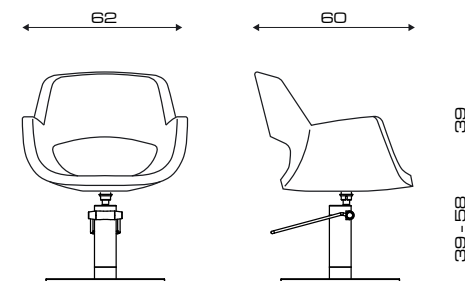

- VERSIONI
- MODELS
- VERSIONS
- VERSIONEN
- GIREVOLE
- SWIVEL
- TOURNANT
- DREHBAR

- IDRAULICA BLOC. 2 ANNI GARANZIA
- LOCKABLE PUMP 2 YEARS WARR.
- HYDR. AVEC BLOC.GARANTIE 2 ANS
- ARRETIERBARE PUMPE GARANTIE 2 JAHREN

- ACCESSORI
- ACCESSORIES
- ACCESSOIRES
- ZUBEHÖR



COD. 119.3R

COD. 119.8R

COD. SPECIAL

- SKAI SPECIAL
- SKAI SPÉCIAL
- SKAI SPÉCIAL
- SKAI SPECIAL

COD. 43

- POGGIAPIEDI (SOLO PER POMPA IDR. BLOC.)
- FOOTREST (ONLY WITH LOCKABLE PUMP)
- REPOSE-PIEDS (POUR PIÈTEMENT AVEC BLOC.)
- FUSSSTÜTZE (NUR MIT ARRETIERBARE PUMPE)



COD. 119.16L

COD. 119.17L

COD. M0/119

- FODERINA SCHIENALE
- BACKREST COVER
- HOUSSE DE PROTECTION DOSSIER
- SCHUTZHÜLLE FÜR RÜCKENLEHNE AUS PVC

- SUPPLEMENTO POMPA 5 ANNI GARANZIA
- SURCHARGE 5 YEARS PUMP WARRANTY
- SUPPLÉMENT POMPE 5 GARANTIE 5 ANS
- ZUSCHLAG FÜR PUMPE 5 JAHREN GARANTIE



COD. 119.55

COD. 119.57

MR. PAUL

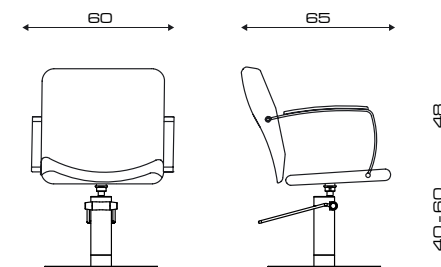

- BRACCIOLI IMBOTTITI
- PADDED ARMREST
- ACCOUDOIRS REMBOURRÉS EN SKAI
- GEPOLSTERTE ARMLEHNEN

- VERSIONI
- MODELS
- VERSIONS
- VERSIONEN
- GIREVOLE
- SWIVEL
- TOURNANT
- DREHBAR
- IDRAULICA BLOC. 2 ANNI GARANZIA
- LOCKABLE PUMP 2 YEARS WARR.
- HYDR. AVEC BLOC. GARANTIE 2 ANS
- ARRETIERBARE PUMPE GARANTIE 2 JAHREN

- ACCESSORI
- ACCESSORIES
- ACCESSOIRES
- ZUBEHÖR



COD. 70.3R

COD. 70.8R



COD. 70.16L

COD. 70.17L



COD. 70.55

COD. 70.57

COD. SPECIAL

- SKAI SPECIAL
- SKAI SPECIAL
- SKAI SPÉCIAL
- SKAI SPECIAL

COD. M0/70

- FODERINA SCHIENALE
- BACKREST COVER
- HOUSSE DE PROTECTION DOSSIER
- SCHUTZHÜLLE FÜR RÜCKENLEHNE AUS PVC

COD. 154

- POGGIATESTA
- HEADREST
- REPOSE-TÊTE
- KOPFSTÜTZE

COD. BRACC.

- BRACCIOLI IMBOTTITI
- PADDED ARMREST
- ACCOUDOIRS REMBOURRÉS EN SKAI
- GEPOLSTERTE ARMLEHNEN

COD. 43

- POGGIAPIEDI (SOLO PER POMPA IDR. BLOC.)
- FOOTREST (ONLY WITH LOCKABLE PUMP)
- REPOSE-PIEDS (POUR PIÈTEMENT AVEC BLOC.)
- FUSSTÜTZE (NUR MIT ARRETIERBARE PUMPE)

- SUPPLEMENTO POMPA 5 ANNI GARANZIA
- SURCHARGE 5 YEARS PUMP WARRANTY
- SUPPLÉMENT POMPE 5 GARANTIE 5 ANS
- ZUSCHLAG FÜR PUMPE 5 JAHREN GARANTIE

MR. PAUL OPTIMA

EMBOSSING NON DISPONIBILE
EMBOSSING NOT AVAILABLE
EMBOSSING PAS DISPONIBLE
EMBOSSING NICHT VERFÜGBAR

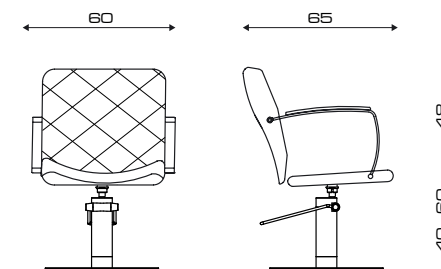

- BRACCIOLI IMBOTTITI
- PADDED ARMREST
- ACCOUDOIRS REMBOURRÉS EN SKAI
- GEPOLSTERTE ARMLEHNEN

- VERSIONI
- MODELS
- VERSIONS
- VERSIONEN
- GIREVOLE
- SWIVEL
- TOURNANT
- DREHBAR
- IDRAULICA BLOC. 2 ANNI GARANZIA
- LOCKABLE PUMP 2 YEARS WARR.
- HYDR. AVEC BLOC. GARANTIE 2 ANS
- ARRETIERBARE PUMPE GARANTIE 2 JAHREN

- ACCESSORI
- ACCESSORIES
- ACCESSOIRES
- ZUBEHÖR



COD. 70B.3R

COD. 70B.8R



COD. 70B.16L

COD. 70B.17L



COD. 70B.55

COD. 70B.57

COD. SPECIAL

- SKAI SPECIAL
- SKAI SPECIAL
- SKAI SPÉCIAL
- SKAI SPECIAL

COD. M0/70

- FODERINA SCHIENALE
- BACKREST COVER
- HOUSSE DE PROTECTION DOSSIER
- SCHUTZHÜLLE FÜR RÜCKENLEHNE AUS PVC

COD. 154

- POGGIATESTA
- HEADREST
- REPOSE-TÊTE
- KOPFSTÜTZE

COD. BRACC.

- BRACCIOLI IMBOTTITI
- PADDED ARMREST
- ACCOUDOIRS REMBOURRÉS EN SKAI
- GEPOLSTERTE ARMLEHNEN

COD. 43

- POGGIAPIEDI (SOLO PER POMPA IDR. BLOC.)
- FOOTREST (ONLY WITH LOCKABLE PUMP)
- REPOSE-PIEDS (POUR PIÈTEMENT AVEC BLOC.)
- FUSSTÜTZE (NUR MIT ARRETIERBARE PUMPE)

- SUPPLEMENTO POMPA 5 ANNI GARANZIA
- SURCHARGE 5 YEARS PUMP WARRANTY
- SUPPLÉMENT POMPE 5 GARANTIE 5 ANS
- ZUSCHLAG FÜR PUMPE 5 JAHREN GARANTIE

NIVA

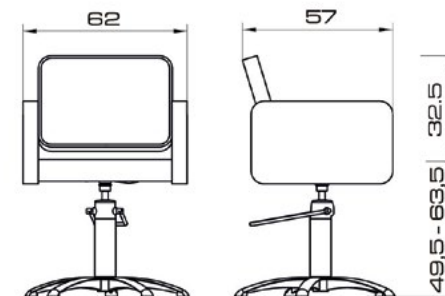

- VERSIONI
- MODELS
- VERSIONS
- VERSIONEN

- IDRAULICA BLOC. 2 ANNI GARANZIA, COLORE NERO B01
- LOCKABLE PUMP 2 YEARS WARR., COLOUR BLACK B01
- HYDR. AVEC BLOC.GARANTIE 2 ANS, COULEUR NOIR B01
- ARRETIERBARE PUMPE GARANTIE 2 JAHREN, VERFÜGBAREN FARBEN B01

- ACCESSORI
- ACCESSORIES
- ACCESSOIRES
- ZUBEHÖR

COD. 23.8R

COD. 23.17L

COD. BASIC

- SKAI BASIC, DIVERSO DA B01
- SKAI BASIC, DIFFERENT FROM B01
- SKAI BASIC, DIFFERENT DE B01
- SKAI BASIC ANDERE ALS B01

COD. SPECIAL

- SKAI SPECIAL
- SKAI SPÉCIAL
- SKAI SPÉCIAL
- SKAI SPECIAL

COD. M0/23

- FODERINA SCHIENALE
- BACKREST COVER
- HOUSSE DE PROTECTION DOSSIER
- SCHUTZHÜLLE FÜR RÜCKENLEHNE AUS PVC

COD. 43

- POGGIAPIEDI (SOLO PER POMPA IDR. BLOC.)
- FOOTREST (ONLY WITH LOCKALE PUMP)
- REPOSE-PIEDS (POUR PIÈTEMENT AVEC BLOC.)
- FUSSSTÜTZE (NUR MIT ARRETIERBARE PUMPE)

- SUPPLEMENTO POMPA 5 ANNI GARANZIA
- SURCHARGE 5 YEARS PUMP WARRANTY
- SUPPLÉMENT POMPE 5 GARANTIE 5 ANS
- ZUSCHLAG FÜR PUMPE 5 JAHREN GARANTIE





NUBI



COD. 29.8R



COD. 29.17L



COD. 29.102

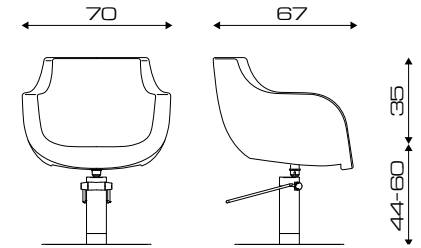

- VERSIONI
- MODELS
- VERSIONS
- VERSIONEN

- GIREVOLE
- SWIVEL
- TOURNANT
- DREHBAR

- IDRAULICA BLOC. 2 ANNI GARANZIA
- LOCKABLE PUMP 2 YEARS WARR.
- HYDR. AVEC BLOC.GARANTIE 2 ANS
- ARRETIERBARE PUMPE GARANTIE 2 JAHREN

- ACCESSORI
- ACCESSORIES
- ACCESSOIRES
- ZUBEHÖR



COD. 29.3R

COD. 29.8R

COD. SPECIAL

- SKAI SPECIAL
- SKAI SPECIAL
- SKAI SPECIAL
- SKAI SPECIAL

COD. 43

- POGGIAPIEDI (SOLO PER POMPA IDR. BLOC.)
- FOOTREST (ONLY WITH LOCKABLE PUMP)
- REPOSE-PIEDS (POUR PIÈTEMENT AVEC BLOC.)
- FUSSSTÜTZE (NUR MIT ARRETIERBARE PUMPE)



COD. 29.16L

COD. 29.17L

COD. M0/29

- FODERINA SCHIENALE
- BACKREST COVER
- HOUSSE DE PROTECTION DOSSIER
- SCHUTZHÜLLE FÜR RÜCKENLEHNE AUS PVC

- SUPPLEMENTO POMPA 5 ANNI GARANZIA
- SURCHARGE 5 YEARS PUMP WARRANTY
- SUPPLEMENT POMPE 5 GARANTIE 5 ANS
- ZUSCHLAG FÜR PUMPE 5 JAHREN GARANTIE



BIG

COD. 29.102

NUBI LIFT

Carsat

NEWS

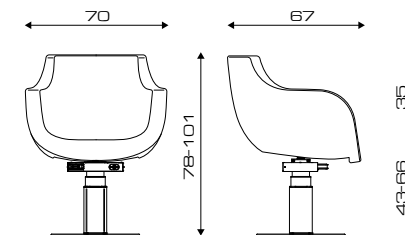

COD. 29.60E + POG

- BASE GIREVOLE ELETTRICA A BATTERIA CON COMANDO A PEDALE WIRELESS.
- BATTERY-ELECTRIC SWIVEL BASE WITH WIRELESS FOOT CONTROL.
- BASE PIVOTANTE ÉLECTRIQUE ALIMENTÉE PAR BATTERIE AVEC COMMANDE AU PIED SANS FIL.
- BATTERIEBETRIEBENER ELEKTRISCHER DREHFUSS MIT KABELLOSER FUßSTEUERUNG.

- VERSIONI
- MODELS
- VERSIONS
- VERSIONEN

- ACCESSORI
- ACCESSORIES
- ACCESSOIRES
- ZUBEHÖR

COD. 29.60E

COD. SPECIAL

- SKAI SPECIAL
- SKAI SPECIAL
- SKAI SPECIAL
- SKAI SPECIAL

COD. M0/29

- FODERINA SCHIENALE
- BACKREST COVER
- HOUSSE DE PROTECTION DOSSIER
- SCHUTZHÜLLE FÜR RÜCKENLEHNE AUS PVC

COD. POG

- POGGIAPIEDI
- FOOTREST
- REPOSE-PIEDS
- FUSSTÜTZE

OYSTER

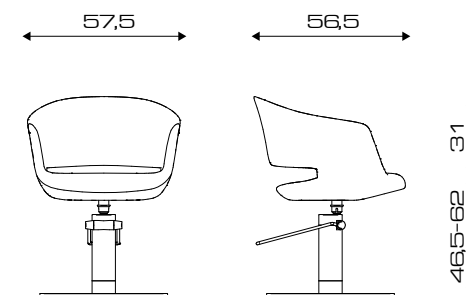

- VERSIONI
- MODELS
- VERSIONS
- VERSIONEN

- GIREVOLE
- SWIVEL
- TOURNANT
- DREHBAR

- IDRAULICA BLOC. 2 ANNI GARANZIA
- LOCKABLE PUMP 2 YEARS WARR.
- HYDR. AVEC BLOC.GARANTIE 2 ANS
- ARRETIERBARE PUMPE GARANTIE 2 JAHREN

- ACCESSORI
- ACCESSORIES
- ACCESSOIRES
- ZUBEHÖR



COD. 108.3R
€ 734,00

COD. 108.8R
€ 855,00



COD. 108.16L
€ 880,00

COD. 108.17L
€ 1.000,00

COD. SPECIAL

- SKAI SPECIAL
- SKAI SPÉCIAL
- SKAI SPÉCIAL
- SKAI SPECIAL

€ 120,00

COD. M0/108

- FODERINA SCHIENALE
- BACKREST COVER
- HOUSSE DE PROTECTION DOSSIER
- SCHUTZHÜLLE FÜR RÜCKENLEHNE AUS PVC

€ 86,00

COD. 43

- POGGIAPIEDI (SOLO PER POMPA IDR. BLOC.)
- FOOTREST (ONLY WITH LOCKABLE PUMP)
- REPOSE-PIEDS (POUR PIÈTEMENT AVEC BLOC.)
- FUSSSTÜTZE (NUR MIT ARRETIERBARE PUMPE)

€ 149,00

- SUPPLEMENTO POMPA 5 ANNI GARANZIA
- SURCHARGE 5 YEARS PUMP WARRANTY
- SUPPLÉMENT POMPE 5 GARANTIE 5 ANS
- ZUSCHLAG FÜR PUMPE 5 JAHREN GARANTIE

€ 145,00

OYSTER LIFT

Carsat

NEWS

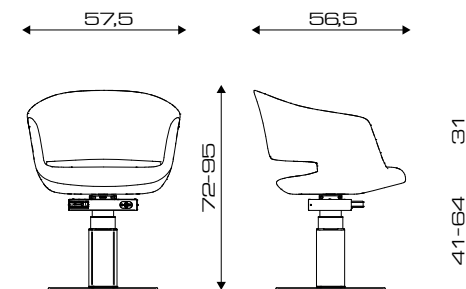

COD. 108.60E + POG

- BASE GIREVOLE ELETTRICA A BATTERIA CON COMANDO A PEDALE WIRELESS.
- BATTERY-ELECTRIC SWIVEL BASE WITH WIRELESS FOOT CONTROL.
- BASE PIVOTANTE ÉLECTRIQUE ALIMENTÉE PAR BATTERIE AVEC COMMANDE AU PIED SANS FIL.
- BATTERIEBETRIEBENER ELEKTRISCHER DREHFUSS MIT KABELLOSER FUßSTEUERUNG.

- VERSIONI
- MODELS
- VERSIONS
- VERSIONEN

- ACCESSORI
- ACCESSORIES
- ACCESSOIRES
- ZUBEHÖR

COD. 108.60E

COD. SPECIAL

- SKAI SPECIAL
- SKAI SPECIAL
- SKAI SPECIAL
- SKAI SPECIAL

COD. M0/108

- FODERINA SCHIENALE
- BACKREST COVER
- HOUSSE DE PROTECTION DOSSIER
- SCHUTZHÜLLE FÜR RÜCKENLEHNE AUS PVC

COD. POG

- POGGIAPIEDI.
- FOOTREST.
- REPOSE-PIEDS.
- FUSSTÜTZE.

OYSTER OPTIMA

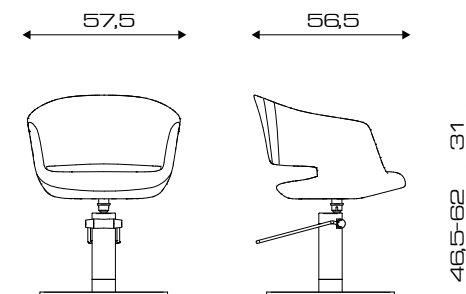

- VERSIONI
- MODELS
- VERSIONS
- VERSIONEN
- GIREVOLE
- SWIVEL
- TOURNANT
- DREHBAR
- IDRAULICA BLOC. 2 ANNI GARANZIA
- LOCKABLE PUMP 2 YEARS WARR.
- HYDR. AVEC BLOC.GARANTIE 2 ANS
- ARRETIERBARE PUMPE GARANTIE 2 JAHREN

- ACCESSORI
- ACCESSORIES
- ACCESSOIRES
- ZUBEHÖR



COD. 108B.3R

COD. 108B.8R

COD. SPECIAL

- SKAI SPECIAL
- SKAI SPÉCIAL
- SKAI SPÉCIAL
- SKAI SPECIAL

COD. 43

- POGGIAPIEDI (SOLO PER POMPA IDR. BLOC.)
- FOOTREST (ONLY WITH LOCKABLE PUMP)
- REPOSE-PIEDS (POUR PIÈTEMENT AVEC BLOC.)
- FUSSSTÜTZE (NUR MIT ARRETIERBARE PUMPE)



COD. 108B.16L

COD. 108B.17L

COD. M0/108

- FODERINA SCHIENALE
- BACKREST COVER
- HOUSSE DE PROTECTION DOSSIER
- SCHUTZHÜLLE FÜR RÜCKENLEHNE AUS PVC

- SUPPLEMENTO POMPA 5 ANNI GARANZIA
- SURCHARGE 5 YEARS PUMP WARRANTY
- SUPPLÉMENT POMPE 5 GARANTIE 5 ANS
- ZUSCHLAG FÜR PUMPE 5 JAHREN GARANTIE

SE-X

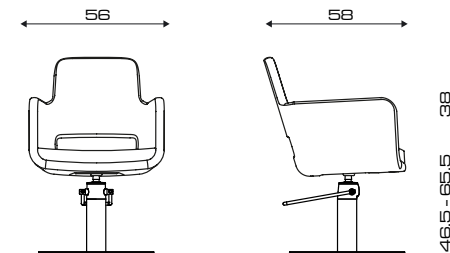

- VERSIONI
- MODELS
- VERSIONS
- VERSIONEN
- GIREVOLE
- SWIVEL
- TOURNANT
- DREHBAR

- IDRAULICA BLOC. 5 ANNI GARANZIA
- LOCKABLE PUMP 5 YEARS WARR.
- HYDR. AVEC BLOC.GARANTIE 5 ANS
- ARRETIERBARE PUMPE GARANTIE 5 JAHREN

- ACCESSORI
- ACCESSORIES
- ACCESSOIRES
- ZUBEHÖR



COD. 118.3R

COD. 118.7R



COD. 118.16L

COD. 118.19L



COD. 118.55

COD. 118.56

COD. SPECIAL

- SKAI SPECIAL
- SKAI SPECIAL
- SKAI SPECIAL
- SKAI SPECIAL

COD. M0/118

- FODERINA SCHIENALE
- BACKREST COVER
- HOUSSE DE PROTECTION DOSSIER
- SCHUTZHÜLLE FÜR RÜCKENLEHNE AUS PVC

COD. 43

- POGGIAPIEDI (SOLO PER POMPA IDR. BLOC.)
- FOOTREST (ONLY WITH LOCKABLE PUMP)
- REPOSE-PIEDS (POUR PIÈTEMENT AVEC BLOC.)
- FUSSSTÜTZE (NUR MIT ARRETIERBARE PUMPE)

- PER POMPA 2 ANNI GARANZIA, DETRARRE
- FOR 2 YEARS PUMP WARRANTY, DEDUCT
- POUR POMPE GARANTIE 2 ANS, DÉDUIRE
- FÜR PUMPE 2 JAHREN GARANTIE, ABZIEHEN

STILO

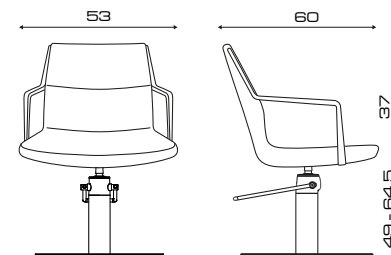

- VERSIONI
- MODELS
- VERSIONS
- VERSIONEN
- GIREVOLE
- SWIVEL
- TOURNANT
- DREHBAR

- IDRAULICA BLOC. 2 ANNI GARANZIA
- LOCKABLE PUMP 2 YEARS WARR.
- HYDR. AVEC BLOC.GARANTIE 2 ANS
- ARRETIERBARE PUMPE GARANTIE 2 JAHREN

- ACCESSORI
- ACCESSORIES
- ACCESSOIRES
- ZUBEHÖR



COD. 22.11R

COD. 22.9R

COD. SPECIAL

- SKAI SPECIAL
- SKAI SPÉCIAL
- SKAI SPÉCIAL
- SKAI SPECIAL

COD. 43

- POGGIAPIEDI (SOLO PER POMPA IDR. BLOC.)
- FOOTREST (ONLY WITH LOCKABLE PUMP)
- REPOSE-PIEDS (POUR PIÈTEMENT AVEC BLOC.)
- FUSSSTÜTZE (NUR MIT ARRETIERBARE PUMPE)



COD. 22.16L

COD. 22.17L

COD. M0/22

- FODERINA SCHIENALE
- BACKREST COVER
- HOUSSE DE PROTECTION DOSSIER
- SCHUTZHÜLLE FÜR RÜCKENLEHNE AUS PVC

- SUPPLEMENTO POMPA 5 ANNI GARANZIA
- SURCHARGE 5 YEARS PUMP WARRANTY
- SUPPLÉMENT POMPE 5 GARANTIE 5 ANS
- ZUSCHLAG FÜR PUMPE 5 JAHREN GARANTIE

SUPREME



COD. 34.8R



COD. 34.17L



COD. 34.102

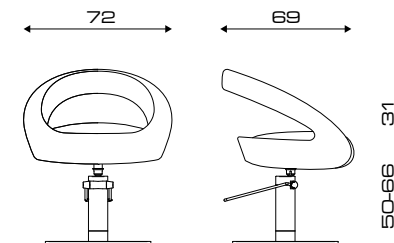

- VERSIONI
- MODELS
- VERSIONS
- VERSIONEN
- GIREVOLE
- SWIVEL
- TOURNANT
- DREHBAR
- IDRAULICA BLOC. 2 ANNI GARANZIA
- LOCKABLE PUMP 2 YEARS WARR.
- HYDR. AVEC BLOC.GARANTIE 2 ANS
- ARRETIERBARE PUMPE GARANTIE 2 JAHREN

- ACCESSORI
- ACCESSORIES
- ACCESSOIRES
- ZUBEHÖR



COD. 34.3R

COD. 34.8R



COD. 34.16L

COD. 34.17L



BIG

COD. 34.102

COD. SPECIAL

- SKAI SPECIAL
- SKAI SPECIAL
- SKAI SPECIAL
- SKAI SPECIAL

COD. M0/34

- FODERINA SCHIENALE
- BACKREST COVER
- HOUSSE DE PROTECTION DOSSIER
- SCHUTZHÜLLE FÜR RÜCKENLEHNE AUS PVC

COD. 43

- POGGIAPIEDI (SOLO PER POMPA IDR. BLOC.)
- FOOTREST (ONLY WITH LOCKABLE PUMP)
- REPOSE-PIEDS (POUR PIÈTEMENT AVEC BLOC.)
- FUSSSTÜTZE (NUR MIT ARRETIERBARE PUMPE)

- SUPPLEMENTO POMPA 5 ANNI GARANZIA
- SURCHARGE 5 YEARS PUMP WARRANTY
- SUPPLEMENT POMPE 5 GARANTIE 5 ANS
- ZUSCHLAG FÜR PUMPE 5 JAHREN GARANTIE

TAU

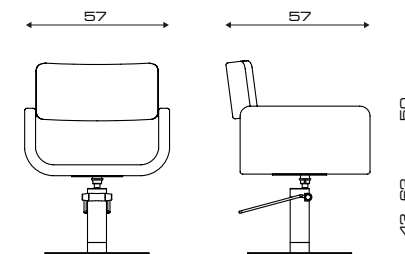

- VERSIONI
- MODELS
- VERSIONS
- VERSIONEN
- GIREVOLE
- SWIVEL
- TOURNANT
- DREHBAR

- IDRAULICA BLOC. 2 ANNI GARANZIA
- LOCKABLE PUMP 2 YEARS WARR.
- HYDR. AVEC BLOC.GARANTIE 2 ANS
- ARRETIERBARE PUMPE GARANTIE 2 JAHREN

- ACCESSORI
- ACCESSORIES
- ACCESSOIRES
- ZUBEHÖR



COD. 62.3R

COD. 62.8R



COD. 62.16L

COD. 62.17L



COD. 62.55

COD. 62.57

COD. SPECIAL

- SKAI SPECIAL
- SKAI SPECIAL
- SKAI SPÉCIAL
- SKAI SPECIAL

COD. M0/62

- FODERINA SCHIENALE
- BACKREST COVER
- HOUSSE DE PROTECTION DOSSIER
- SCHUTZHÜLLE FÜR RÜCKENLEHNE AUS PVC

COD. 154

- POGGIATESTA
- HEADREST
- REPOSE-TÊTE
- KOPFSTÜTZE

COD. 43

- POGGIAPIEDI (SOLO PER POMPA IDR. BLOC.)
- FOOTREST (ONLY WITH LOCKABLE PUMP)
- REPOSE-PIEDS (POUR PIÈTEMENT AVEC BLOC.)
- FUSSSTÜTZE (NUR MIT ARRETIERBARE PUMPE)

- SUPPLEMENTO POMPA 5 ANNI GARANZIA
- SURCHARGE 5 YEARS PUMP WARRANTY
- SUPPLÉMENT POMPE 5 GARANTIE 5 ANS
- ZUSCHLAG FÜR PUMPE 5 JAHREN GARANTIE

VENTO

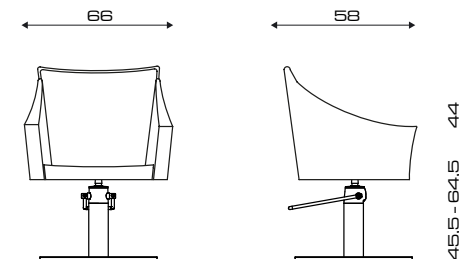

- VERSIONI
- MODELS
- VERSIONS
- VERSIONEN
- GIREVOLE
- SWIVEL
- TOURNANT
- DREHBAR

- IDRAULICA BLOC. 5 ANNI GARANZIA
- LOCKABLE PUMP 5 YEARS WARR.
- HYDR. AVEC BLOC.GARANTIE 5 ANS
- ARRETIERBARE PUMPE GARANTIE 5 JAHREN

- ACCESSORI
- ACCESSORIES
- ACCESSOIRES
- ZUBEHÖR



COD. 76.3R

COD. 76.7R



COD. 76.16L

COD. 76.19L



COD. 76.55

COD. 76.56

COD. SPECIAL

- SKAI SPECIAL
- SKAI SPÉCIAL
- SKAI SPÉCIAL
- SKAI SPECIAL

COD. M0/76

- FODERINA SCHIENALE
- BACKREST COVER
- HOUSSE DE PROTECTION DOSSIER
- SCHUTZHÜLLE FÜR RÜCKENLEHNE AUS PVC

COD. 43

- POGGIAPIEDI (SOLO PER POMPA IDR. BLOC.)
- FOOTREST (ONLY WITH LOCKABLE PUMP)
- REPOSE-PIEDS (POUR PIÈTEMENT AVEC BLOC.)
- FUSSSTÜTZE (NUR MIT ARRETIERBARE PUMPE)

- PER POMPA 2 ANNI GARANZIA, DETRARRE
- FOR 2 YEARS PUMP WARRANTY, DEDUCT
- POUR POMPE GARANTIE 2 ANS, DÉDUIRE
- FÜR PUMPE 2 JAHREN GARANTIE, ABZIEHEN



COD. FIN BLACK 7R

- SUPPLEMENTO BASE A STELLA E POMPA 5 ANNI GARANZIA VERNICIATI NERO OPACO.
- EXTRA CHARGE STAR BASE AND 5-YEAR WARRANTY PUMP PAINTED MATT BLACK.
- SUPPLEMENT BASE ÉTOILE ET POMPE GARANTIE 5 ANS PEINTE EN NOIR MAT.
- ZUSCHLAG STERNSOCKEL UND PUMPE MIT 5 JAHREN GARANTIE, MATTSCHWARZ LACKIERT



COD. FIN BLACK 19

- SUPPLEMENTO BASE DISCO E POMPA 5 ANNI GARANZIA VERNICIATI NERO OPACO.
- EXTRA CHARGE DISCO BASE AND 5-YEAR WARRANTY PUMP PAINTED MATT BLACK.
- SUPPLEMENT BASE DISCO ET POMPE GARANTIE 5 ANS PEINTE EN NOIR MAT.
- ZUSCHLAG TELLERFUSS UND PUMPE MIT 5 JAHREN GARANTIE, MATTSCHWARZ LACKIERT.

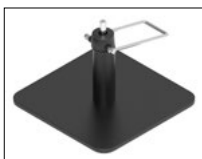

COD. FIN BLACK 56

- SUPPLEMENTO BASE QUADRA E POMPA 5 ANNI GARANZIA VERNICIATI NERO OPACO.
- EXTRA CHARGE SQUARE BASE AND 5-YEAR WARRANTY PUMP PAINTED MATT BLACK.
- SUPPLEMENT BASE CARRÉE ET POMPE GARANTIE 5 ANS PEINTE EN NOIR MAT.
- ZUSCHLAG ECKIGE TELLERFUSS UND PUMPE MIT 5 JAHREN GARANTIE, MATTSCHWARZ LACKIERT



COD. FIN BLACK 8R

- SUPPLEMENTO BASE A STELLA E POMPA 2 ANNI GARANZIA VERNICIATI NERO OPACO.
- EXTRA CHARGE STAR BASE AND 2-YEAR WARRANTY PUMP PAINTED MATT BLACK.
- SUPPLEMENT BASE ÉTOILE ET POMPE GARANTIE 2 ANS PEINTE EN NOIR MAT.
- ZUSCHLAG STERNSOCKEL UND PUMPE MIT 2 JAHREN GARANTIE, MATTSCHWARZ LACKIERT.



COD. FIN BLACK 17

- SUPPLEMENTO BASE DISCO E POMPA 2 ANNI GARANZIA VERNICIATI NERO OPACO.
- EXTRA CHARGE DISCO BASE AND 2-YEAR WARRANTY PUMP PAINTED MATT BLACK.
- SUPPLEMENT BASE DISCO ET POMPE GARANTIE 2 ANS PEINTE EN NOIR MAT.
- ZUSCHLAG TELLERFUSS UND PUMPE MIT 2 JAHREN GARANTIE, MATTSCHWARZ LACKIERT.



COD. FIN BLACK 57

- SUPPLEMENTO BASE QUADRA E POMPA 2 ANNI GARANZIA VERNICIATI NERO OPACO.
- EXTRA CHARGE SQUARE BASE AND 2-YEAR WARRANTY PUMP PAINTED MATT BLACK.
- SUPPLEMENT BASE CARRÉE ET POMPE GARANTIE 2 ANS PEINTE EN NOIR MAT.
- ZUSCHLAG ECKIGE TELLERFUSS UND PUMPE MIT 2 JAHREN GARANTIE, MATTSCHWARZ LACKIERT.

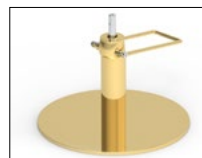

COD. FIN GOLD 19

- SUPPLEMENTO CROMATURA ORO PER BASE A DISCO E CORPO POMPA 5 ANNI GARANZIA.
- EXTRA CHARGE FOR GOLD CHROME-PLATING DISCO BASE AND 5 YEARS WARRANTY PUMP COVER.
- CHROMAGE COULEUR OR POUR BASE DISCO E CHACHE POMPE 5 ANS GARANTIE.
- GOLDCHROMZUSATZ FÜR TELLERFUSS UND PUMPENKÖRPER 5 JAHRE GARANTIE



COD. FIN GOLD 56

- SUPPLEMENTO CROMATURA ORO PER BASE QUADRA E CORPO POMPA 5 ANNI GARANZIA.
- EXTRA CHARGE FOR GOLD CHROME-PLATING SQUARE BASE AND 5 YEARS WARRANTY PUMP COVER.
- CHROMAGE COULEUR OR POUR BASE CARRE' E CHACHE POMPE 5 ANS GARANTIE.
- GOLDCHROMZUSATZ FÜR QUADRATISCHEN SOCKEL UND PUMPENKÖRPER 5 JAHRE GARANTIE

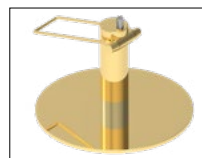

COD. FIN GOLD 17

- SUPPLEMENTO CROMATURA ORO PER BASE A DISCO E CORPO POMPA 2 ANNI GARANZIA.
- EXTRA CHARGE FOR GOLD CHROME-PLATING DISCO BASE AND 2 YEARS WARRANTY PUMP COVER.
- CHROMAGE COULEUR OR POUR BASE DISCO E CHACHE POMPE 2 ANS GARANTIE.
- GOLDCHROMZUSATZ FÜR TELLERFUSS UND PUMPENKÖRPER 2 JAHRE GARANTIE

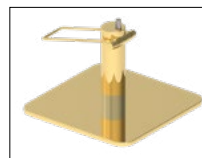

COD. FIN GOLD 57

- SUPPLEMENTO CROMATURA ORO PER BASE QUADRA E CORPO POMPA 2 ANNI GARANZIA.
- EXTRA CHARGE FOR GOLD CHROME-PLATING SQUARE BASE AND 2 YEARS WARRANTY PUMP COVER.
- CHROMAGE COULEUR OR POUR BASE CARRE' E CHACHE POMPE 2 ANS GARANTIE.
- GOLDCHROMZUSATZ FÜR QUADRATISCHEN SOCKEL UND PUMPENKÖRPER 2 JAHRE GARANTIE



COD. 10R

- BASE A STELLA SLIM CON POMPA 5 ANNI GARANZIA - STESSO PREZZO BASE .7R
- SLIM STARBASE, HYDRAULIC PUMP 5 YEARS WARRANTY - SAME PRICE BASE .7R
- PIED ETOILE SLIM AVEC POMPE 5 ANS GARANTIE - MÊME PRIX BASE .7R
- STERNFUSS SLIM MIT PUMPE 5 JAHREN GARANTIE - SELBE PREIS FUSS .7R



COD. 9R

- BASE A STELLA SLIM CON POMPA 2 ANNI GARANZIA - STESSO PREZZO BASE .8R
- SLIM STARBASE, HYDRAULIC PUMP 2 YEARS WARRANTY - SAME PRICE BASE .8R
- PIED ETOILE SLIM AVEC POMPE 2 ANS GARANTIE - MÊME PRIX BASE .8R
- STERNFUSS SLIM MIT PUMPE 2 JAHREN GARANTIE - SELBE PREIS FUSS .8R

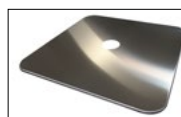

COD. SAT

- COPERTURA SATINATA PER BASE DISCO O QUADRA.
- SATIN COVER ON DISC AND SQUARE BASE
- PIÈTEMENT SATINÉ DISQUE OU CARRÉ
- SATINIERT ABDECKUNG FÜR TELLERFUSS ODER ECKIGE BODENPLATTE.



COD. 154

- POGGIATESTA RIVESTITO IN SKAI PER POLTRONE, CLAIRE MID-OPTIMA, TAU, MR. PAUL, MR. PAUL OPTIMA, FIFTY, COBRA METAL.
- HEADREST FOR CHAIRS, CLAIRE MID, CLAIRE OPTIMA, TAU, MR. PAUL, MR. PAUL OPTIMA, FIFTY, COBRA METAL.
- REPOSE-TÊTE POUR FAUTEUILS, CLAIRE MID, CLAIRE OPTIMA, TAU, MR. PAUL, MR. PAUL OPTIMA, FIFTY, COBRA METAL.
- KOPFSTÜTZE FÜR CLAIRE MID, CLAIRE OPTIMA, TAU, MR. PAUL, MR. PAUL OPTIMA, FIFTY, COBRA METAL.

COD. SPECIAL

- SKAI SPECIAL PER COD. 154
- SKAI SPECIAL FOR COD. 154
- SKAI SPÉCIAL POUR COD. 154
- SKAI SPECIAL FÜR COD. 154



COD. 148

- POGGIATESTA RIVESTITO IN SKAI PER POLTRONA BLADE EASY, BOLERO, JOLIE, NEK.
- HEADREST FOR CHAIRS BLADE EASY, BOLERO, JOLIE, NEK.
- REPOSE-TÊTE POUR FAUTEUILS BLADE EASY, BOLERO, JOLIE, NEK.
- KOPFSTÜTZE FÜR BLADE EASY, BOLERO, JOLIE, NEK.

COD. SPECIAL

- SKAI SPECIAL PER COD. 148
- SKAI SPECIAL FOR COD. 148
- SKAI SPÉCIAL POUR COD. 148
- SKAI SPECIAL FÜR COD. 148

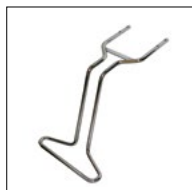

COD. 43

- POGGIAPIEDI SOLO CON POMPA FRENO
- FOOTREST FOR PUMP ONLY
- REPOSE-PIEDS POUR PIÈTEMENT AVEC BLOCAGE
- FUSSSTÜTZE (NUR MIT ARRETIERBARE PUMPE)



COD. 962

- CUSCINO SPECIALE - INDICARE IL MODELLO DELLA POLTRONA E ALTEZZA
- SPECIAL BOOSTER SEAT - REPORT THE CHAIR MODEL AND HEIGHT
- COUSSIN SPECIAL - INDIQUER LE MODEL DE LA FAUTEUIL ET LA HAUTEUR
- KINDER SITZ-KISSEN BITTE MODELL STUHL ANGEBEN UND HÖHE ANZEIGEN

COD. SPECIAL

- SKAI SPECIAL PER COD. 962
- SKAI SPECIAL FOR COD. 962
- SKAI SPÉCIAL POUR COD. 962
- SKAI SPECIAL FÜR COD. 962



COD. 125

- TRAY BRACCIO CORTO PER POLTRONE: BOLERO, BOLERO OPTIMA, JOLIE, LONDRA EASY-MID-OPTIMA, ZONE.
- TECHNICAL TRAY WITH SHORT ARM FOR CHAIRS: BOLERO, BOLERO OPTIMA, JOLIE, LONDRA EASY-MID-OPTIMA, ZONE.
- PLATEAU TRAY AVEC BRAS COURT POUR FAUTEUILS: BOLERO, BOLERO OPTIMA, JOLIE, LONDRA EASY-MID-OPTIMA, ZONE.
- ABLAUF TRAY, KURZE ARM FÜR: BOLERO, BOLERO OPTIMA, JOLIE, LONDRA EASY-MID-OPTIMA, ZONE.



COD. 124

- TRAY BRACCIO LUNGO PER POLTRONE: AMELIA, AMY, KELLY, MOR, SE-X
- TECHNICAL TRAY WITH LONG ARM FOR CHAIRS: AMELIA, AMY, KELLY, MOR, SE-X
- PLATEAU TRAY AVEC BRAS LONGUE POUR FAUTEUILS: AMELIA, AMY, KELLY, MOR, SE-X
- ABLAUF TRAY, LANGEN ARM, FÜR: AMELIA, AMY, KELLY, MOR, SE-X



COD. CLICHE' EMBOSSING

- REALIZZAZIONE CLICHÉ PER EMBOSSING PERSONALIZZATO.
- PERSONALIZED CLICHE FOR EMBOSSING.
- REALISATION CLICHE POUR EMBOSSING PERSONALISÉ.
- KLISCHEE REALISIERUNG FÜR PERSONALISIERTE EMBOSSING.



COD. EMBOSSING

- STAMPA EMBOSSING SINGOLA.
- EMBOSSING PRINTING.
- IMPRESSION EMBOSSING.
- EINZELN EMBOSSING AUSDRUCK.

POLTRONE UOMO E UNISEX GENTLEMEN'S AND UNISEX CHAIRS FAUTEUILS HOMMES ET UNISEX HERREN UND UNISEX-STÜHLE

IT COME TUTTE LE POLTRONE PIETRANERA, ANCHE QUELLE UOMO E UNISEX SONO PENSATE PER PERMETTERE AL CLIENTE DI ABBANDONARSI PIACEVOLMENTE, MENTRE IL COIFFEUR SI PRENDE CURA DELLA SUA NUOVA IMMAGINE. L'ARTIGIANALITÀ DEI MATERIALI SI UNISCE ALLA FUNZIONALITÀ E AL DESIGN, REGALANDO UN'ESPERIENZA UNICA.

EN JUST LIKE ALL PIETRANERA CHAIRS, THOSE FOR BARBER'S AND UNISEX SALONS ALLOW CLIENTS TO SNUGGLE DOWN WHILE THE HAIRSTYLIST CREATES THEIR NEW IMAGE. ARTISANAL MATERIALS ENHANCE FUNCTIONALITY AND DESIGN TO PROVIDE A UNIQUE EXPERIENCE.

FR COMME TOUS LES FAUTEUILS PIETRANERA, MÊME LES FAUTEUILS HOMME ET UNISEX SONT CONÇUS POUR PERMETTRE AU CLIENT DE S'ABANDONNER AGRÉABLEMENT, PENDANT QUE LE COIFFEUR PREND SOIN DE SA NOUVELLE IMAGE. LA PRÉPARATION ARTISANALE DES MATÉRIAUX S'ALLIE À LA FONCTIONNALITÉ ET AU DESIGN, EN OFFRANT UNE EXPÉRIENCE UNIQUE.

DE WIE ALLE SESSEL PIETRANERA, WURDEN AUCH DIE SERIEN FÜR DEN MANN UND UNISEX SO KONZIPIERT, DASS SIE ES DEM KUNDEN ERLAUBEN SICH ES IN DEM SESSEL BEQUEM ZU MACHEN UND ZU ENTSPANNEN, WÄHREND DER COIFFEUR SICH UM SEIN NEUES IMAGE KÜMMERT. DIE HANDWERKLICHKEIT DER MATERIALIEN VEREINT SICH MIT DER FUNKTIONALITÄT UND DEM DESIGN UND ERLAUBEN EINE EINZIGARTIGE SITZERFAHRUNG.





5'60



- VERSIONI
- MODELS
- VERSIONS
- VERSIONEN

COD. 560

- RECLINABILE, POGGIATESTA REGOLABILE IN ALTEZZA, PEDANA, POMPA IDRAULICA BLOCCABILE, STRUTTURA BIANCA O NERA.
- RECLINABLE, HEIGHT ADJUSTABLE HEADREST, FOOTREST, HYDRAULIC LOCKABLE PUMP, WHITE OR BLACK FRAME
- INCLINABLE, APPUI-TÊTE RÉGLABLE EN HAUTEUR, REPOSE-PIEDS, POMPE HYDRAULIQUE BLOCABLE, STRUCTURE BLANC OU NOIR.
- VERSTELLBAR, VERSTELLBARE KOPFSTÜTZE, FUSSTÜTZE, ARRETIERBARE PUMPE.



COD. 560 + PED

- ACCESSORI
- ACCESSORIES
- ACCESSOIRES
- ZUBEHÖR

COD. SPECIAL

- SKAI SPECIAL
- SKAI SPECIAL
- SKAI SPECIAL
- SKAI SPECIAL

COD. BRACC.

- BRACCIOLI RIVESTITI
- PADDED ARMRESTS
- ACCOUDOIRS REMBOURRÉS EN SKAI
- GEPOLSTERTE ARMLEHNEN

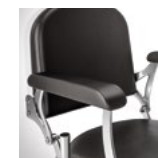
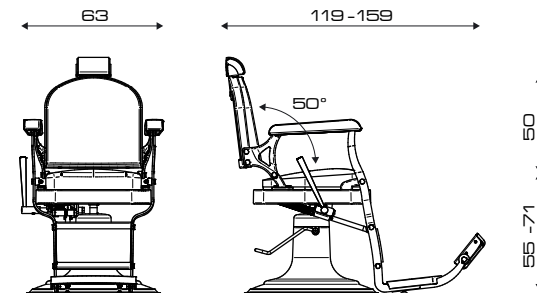

COD. BRACC.



COD. FIN PREMIUM



COD. PED

- COLORI STRUTTURA
- STRUCTURE COLORS
- STRUCTURE COULEURS
- STRUKTUR FARBEN

- NERO LUCIDO
- GLOSSY BLACK
- NOIR BRILLANT
- GLÄNZEND SWARTZ

- BIANCO LUCIDO
- GLOSSY WHITE
- BLANC BRILLANT
- GLÄNZEND WEISS

COD. PED

- RIBALTINA POGGIPIEDI.
- PADDED AND UPHOLSTERED FLAPPING FOOT.
- REPOSE-PIEDS EN SKAI TOURNANT.
- KLAPPBAR FUSSTÜTZE.

COD. FIN PREMIUM

- FINITURA CON BOTTONI SCHIENALE INTERNO.
- VERSION WITH BUTTONS INSIDE THE BACKREST.
- VERSION AVEC BOUTONS À L'INTÉRIEUR DU DOSSIER.
- INNEN RÜCKENLEHNE MIT KNÖPFE.

5'60 LIFT

Carsat

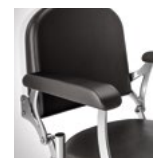
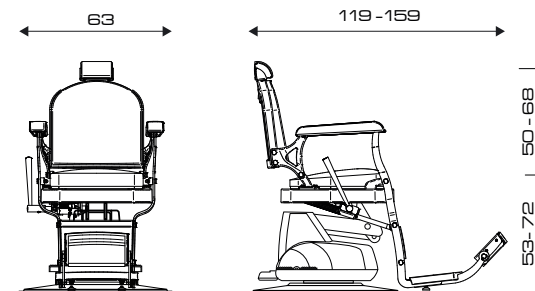

COD. BRACC.



COD. FIN PREMIUM



COD. PED

- VERSIONI
- MODELS
- VERSIONS
- VERSIONEN

COD. 560.EL

- RECLINABILE, POGGIATESTA REGOLABILE IN ALTEZZA, PEDANA, BASE ELETTRICA CON ROTAZIONE BLOCCABILE, STRUTTURA BIANCA O NERA
- RECLINABLE, HEIGHT ADJUSTABLE HEADREST, FOOTREST, MOTORIZED BASE WITH LOCK AND ROTATION, WHITE OR BLACK FRAME
- INCLINABLE, REPOSE-TÊTE RÉGLABLE EN HAUTEUR, REPOSE-PIEDS, PIED ÉLECTRIQUE, ROTATION AVEC BLOCAGE, STRUCTURE BLANC OU NOIR.
- VERSTELLBAR, VERSTELLBARE KOPFSTÜTZE, FUSSTÜTZE, ELEKTRISCHE PUMPE MIT EINSTELLBARE DREHUNG.

- ACCESSORI
- ACCESSORIES
- ACCESSOIRES
- ZUBEHÖR

COD. SPECIAL

- SKAI SPECIAL
- SKAI SPÉCIAL
- SKAI SPÉCIAL
- SKAI SPECIAL

COD. BRACC.

- BRACCIOLI RIVESTITI
- PADDED ARMRESTS
- ACCOUDOIRS REMBOURRÉS EN SKAI
- GEPOLSTERTE ARMLEHNEN

- COLORI STRUTTURA
- STRUCTURE COLORS
- STRUCTURE COULEURS
- STRUKTUR FARBEN



- NERO LUCIDO
- GLOSSY BLACK
- NOIR BRILLANT
- GLÄNZEND SWARTZ



- BIANCO LUCIDO
- GLOSSY WHITE
- BLANC BRILLANT
- GLÄNZEND WEISS

COD. PED

- RIBALTINA POGGIPIEDI.
- PADDED AND UPHOLSTERED FLAPPING FOOT.
- REPOSE-PIEDS EN SKAI TOURNANT.
- KLAPPBAR FUSSTÜTZE.

COD. FIN PREMIUM

- FINITURA CON BOTTONI SCHIENALE INTERNO.
- VERSION WITH BUTTONS INSIDE THE BACKREST.
- VERSION AVEC BOUTONS À L'INTÉRIEUR DU DOSSIER.
- INNEN RÜCKENLEHNE MIT KNÖPFE.

OM-X



COD. 321.28S



COD. 321.28L



COD. 323.28S

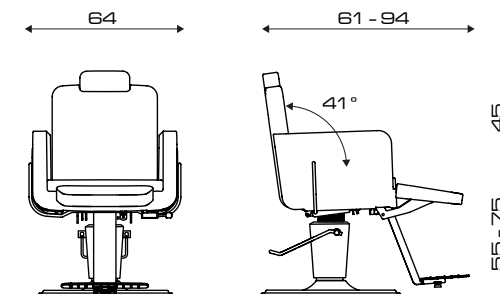

- VERSIONI
- MODELS
- VERSIONS
- VERSIONEN

- ACCESSORI
- ACCESSORIES
- ACCESSOIRES
- ZUBEHÖR

COD. 321.28S

- SCHIENALE RECLINABILE, POGGIATESTA REGOLABILE IN ALTEZZA, PEDANA, POMPA IDRAULICA BLOCCABILE, BASE DISCO SATINATA.
- RECLINABLE BACKREST, HEIGHT ADJUSTABLE HEADREST, FOOTREST, HYDRAULIC LOCKABLE PUMP, SATIN-FINISHED DISC BASE.
- DOSSIER INCLINABLE, APPUI-TÊTE RÉGLABLE EN HAUTEUR, REPOSE-PIÈDS, POMPE HYDRAULIQUE BLOCABLE, BASE À DISQUE SATINÉE
- VERSTELLBARE RÜCKENLEHNE, VERSTELLBARE KOPFSTÜTZE, FUSSTÜTZE, ARRETIERBARE PUMPE, SATINIERTER TELLERFUSS

COD. 321.28L

- SCHIENALE RECLINABILE, POGGIATESTA REGOLABILE IN ALTEZZA, PEDANA, POMPA IDRAULICA BLOCCABILE, BASE DISCO CROMATA.
- RECLINABLE BACKREST, HEIGHT ADJUSTABLE HEADREST, FOOTREST, HYDRAULIC LOCKABLE PUMP, CHROME-PLATED DISC BASE.
- DOSSIER INCLINABLE, APPUI-TÊTE RÉGLABLE EN HAUTEUR, REPOSE-PIÈDS, POMPE HYDRAULIQUE BLOCABLE, BASE À DISQUE CHROMÉE
- VERSTELLBARE RÜCKENLEHNE, VERSTELLBARE KOPFSTÜTZE, FUSSTÜTZE, ARRETIERBARE PUMPE, VERCHROMTER TELLERFUSS

COD. 323.28S

- SCHIENALE RECLINABILE, POGGIATESTA REGOLABILE IN ALTEZZA, PEDANA E ALZAGAMBE, POMPA IDRAULICA BLOCCABILE, BASE DISCO SATINATA.
- RECLINABLE BACKREST, HEIGHT ADJUSTABLE HEADREST, FOOTREST AND LEGREST, HYDRAULIC LOCKABLE PUMP, SATIN-FINISHED DISC BASE.
- DOSSIER INCLINABLE, APPUI-TÊTE RÉGLABLE EN HAUTEUR, REPOSE-PIÈDS ET RELÈVE-JAMBES, POMPE HYDRAULIQUE BLOCABLE, BASE À DISQUE SATINÉE
- VERSTELLBARE RÜCKENLEHNE, VERSTELLBARE KOPFSTÜTZE, FUSSTÜTZE UND BEINAUFLAGE, ARRETIERBARE PUMPE, SATINIERTER TELLERFUSS

COD. SPECIAL

- SKAI SPECIAL
- SKAI SPECIAL
- SKAI SPÉCIAL
- SKAI SPECIAL

OM-X OPTIMA



COD. 321B.28S



COD. 321B.28L



COD. 323B.28S

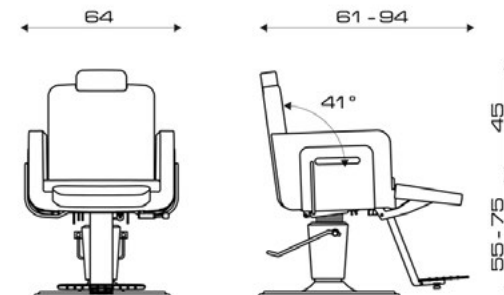

- VERSIONI
- MODELS
- VERSIONS
- VERSIONEN

- ACCESSORI
- ACCESSORIES
- ACCESSOIRES
- ZUBEHÖR

COD. 321B.28S

- SCHIENALE RECLINABILE, POGGIATESTA REGOLABILE IN ALTEZZA, PEDANA, POMPA IDRAULICA BLOCCABILE, BASE DISCO SATINATA E DECORAZIONE LATERALE IN ALLUMINIO.
- RECLINABLE BACKREST, HEIGHT ADJUSTABLE HEADREST, FOOTREST, HYDRAULIC LOCKABLE PUMP, SATIN-FINISHED DISC BASE AND SIDE ALUMINIUM DECORATION.
- DOSSIER INCLINABLE, APPUI-TÊTE RÉGLABLE EN HAUTEUR, REPOSE-PIEDS, POMPE HYDRAULIQUE BLOCABLE, BASE À DISQUE SATINÉE ET DÉCORATION LATÉRALE EN ALUMINIUM.
- VERSTELLBARE RÜCKENLEHNE, VERSTELLBARE KOPFSTÜTZE, FUSSSTÜTZE, ARRETIERBARE PUMPE, SATINIERTER TELLERFUSS UND ALUMINIUM-SEITENDEKORATION.

COD. 321B.28L

- SCHIENALE RECLINABILE, POGGIATESTA REGOLABILE IN ALTEZZA, PEDANA, POMPA IDRAULICA BLOCCABILE, BASE DISCO CROMATA E DECORAZIONE LATERALE IN ALLUMINIO.
- RECLINABLE BACKREST, HEIGHT ADJUSTABLE HEADREST, FOOTREST, HYDRAULIC LOCKABLE PUMP, CHROME-PLATED DISC BASE AND SIDE ALUMINIUM DECORATION.
- DOSSIER INCLINABLE, APPUI-TÊTE RÉGLABLE EN HAUTEUR, REPOSE-PIEDS, POMPE HYDRAULIQUE BLOCABLE, BASE À DISQUE CHROMÉE ET DÉCORATION LATÉRALE EN ALUMINIUM.
- VERSTELLBARE RÜCKENLEHNE, VERSTELLBARE KOPFSTÜTZE, FUSSSTÜTZE, ARRETIERBARE PUMPE, VERCHROMTER TELLERFUSS UND ALUMINIUM-SEITENDEKORATION.

COD. 323B.28S

- SCHIENALE RECLINABILE, POGGIATESTA REGOLABILE IN ALTEZZA, PEDANA E ALZAGAMBE, POMPA IDRAULICA BLOCCABILE, BASE DISCO SATINATA E DECORAZIONE LATERALE IN ALLUMINIO.
- BACKREST RECLINABLE, HEIGHT ADJUSTABLE HEADREST, FOOTREST AND LEGREST, HYDRAULIC LOCKABLE PUMP, SATIN-FINISHED DISC BASE AND ALUMINIUM SIDE ALUMINIUM DECORATION.
- DOSSIER INCLINABLE, APPUI-TÊTE RÉGLABLE EN HAUTEUR, REPOSE-PIEDS ET RELÈVE-JAMBES, POMPE HYDRAULIQUE BLOCABLE, BASE À DISQUE SATINÉE ET DÉCORATION LATÉRALE EN ALUMINIUM.
- VERSTELLBARE RÜCKENLEHNE, VERSTELLBARE KOPFSTÜTZE, FUSSSTÜTZE UND BEINAUFLAGE, ARRETIERBARE PUMPE, SATINIERTER TELLERFUSS UND ALUMINIUM-SEITENDEKORATION.

COD. SPECIAL

- SKAI SPECIAL
- SKAI SPECIAL
- SKAI SPÉCIAL
- SKAI SPECIAL

OM-X LIFT

Carsat

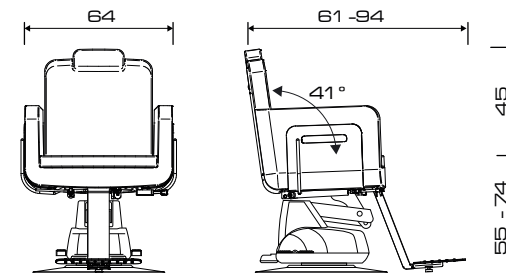

- VERSIONI
- MODELS
- VERSIONS
- VERSIONEN

COD. 321.EL

- RECLINABILE, POGGIATESTA REGOLABILE IN ALTEZZA, PEDANA, BASE ELETTRICA CON ROTAZIONE BLOCCABILE.
- RECLINABLE, HEIGHT ADJUSTABLE HEADREST, FOOTREST, MOTORIZED BASE WITH LOCK AND ROTATION.
- INCLINABLE, REPOSE-TÊTE REGLABLE EN HAUTEUR, REPOSE-PIEDS, PIED ÉLECTRIQUE, ROTATION AVEC BLOCAGE.
- VERSTELLBAR, VERSTELLBARE KOPFSTÜTZE, FUSSSTÜTZE, ELEKTRISCHE PUMPE MIT EINSTELLBARE DREHUNG

- ACCESSORI
- ACCESSORIES
- ACCESSOIRES
- ZUBEHÖR

COD. SPECIAL

- SKAI SPECIAL
- SKAI SPECIAL
- SKAI SPECIAL
- SKAI SPECIAL

OM-X UNISEX

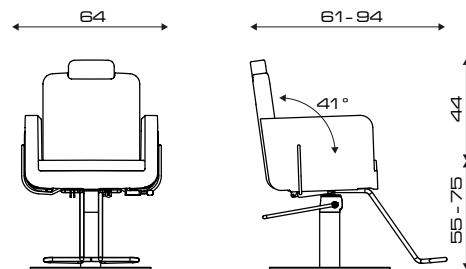

COD. 322.103

- VERSIONI
- MODELS
- VERSIONS
- VERSIONEN

COD. 322.103

- RECLINABILE, POGGIATESTA REGOLABILE IN ALTEZZA, POGGIAPIEDI, POMPA IDRAULICA BLOCCABILE
- RECLINABLE, HEIGHT ADJUSTABLE HEADREST, FOOTREST, HYDRAULIC LOCKABLE PUMP
- INCLINABLE, APPUI-TÊTE REGLABLE EN HAUTEUR, REPOSE-PIEDS, POMPE HYDRAULIQUE BLOCABLE
- VERSTELLBAR, VERSTELLBARE KOPFSTÜTZE, FUSSSTÜTZE, ARRETIERBARE PUMPE

- ACCESSORI
- ACCESSORIES
- ACCESSOIRES
- ZUBEHÖR

COD. SPECIAL

- SKAI SPECIAL
- SKAI SPECIAL
- SKAI SPÉCIAL
- SKAI SPECIAL

OM-X UNISEX OPTIMA

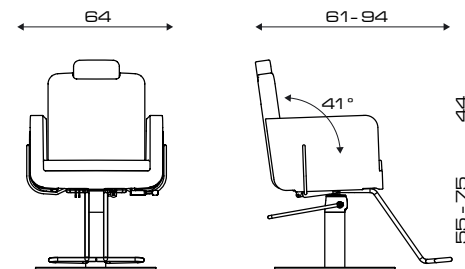

COD. 322B.103

- VERSIONI
- MODELS
- VERSIONS
- VERSIONEN

COD. 322B.103

- RECLINABILE, POGGIATESTA REGOLABILE IN ALTEZZA, POGGIAPIEDI, POMPA IDRAULICA BLOCCABILE, BRACCIOLI CON CARTER LATERALI IN ALLUMINIO
- RECLINABLE, HEIGHT ADJUSTABLE HEADREST, FOOTREST, HYDRAULIC LOCKABLE PUMP, ARMREST WITH ALUMINIUM DECORATION
- INCLINABLE, APPUI-TÊTE REGLABLE EN HAUTEUR, REPOSE-PIEDS, POMPE HYDRAULIQUE BLOCABLE, ACCOUDOIRS AVEC DECORATION EN ALUMINIUM
- VERSTELLBAR, VERSTELLBARE KOPFSTÜTZE UND FUSSSTÜTZE, ARRETIERBARE PUMPE, SEITENARMLEHNEN AUS ALUMINIUM

- ACCESSORI
- ACCESSORIES
- ACCESSOIRES
- ZUBEHÖR

COD. SPECIAL

- SKAI SPECIAL
- SKAI SPECIAL
- SKAI SPÉCIAL
- SKAI SPECIAL

VANITY



COD. 47RP.5RD



COD. 47RP.103

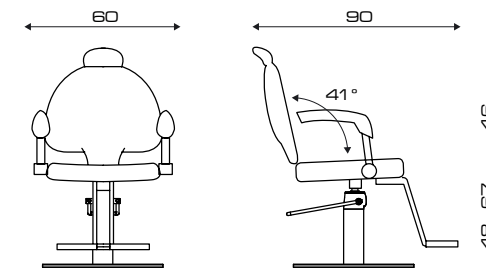

- VERSIONI
- MODELS
- VERSIONS
- VERSIONEN

- ACCESSORI
- ACCESSORIES
- ACCESSOIRES
- ZUBEHÖR



COD. 47RP.5RD

- RECLINABILE, POGGIATESTA REGOLABILE IN ALTEZZA, POGGIAPIEDI, BASE A STELLA CON POMPA IDRAULICA BLOCCABILE 5 ANNI GARANZIA.
- RECLINABLE, HEIGHT ADJUSTABLE HEADREST, FOOTREST, STAR BASE WITH LOCKABLE PUMP 5 YEARS WARRANTY
- INCLINABLE, APPUI-TÊTE REGLABLE EN HAUTEUR, REPOSE-PIEDS, BASE ÉTOILE AVEC POMPE HYDRAULIQUE BLOCABLE GARANTIE 5 ANS.
- KIPPBARES, VERSTELLBARE KOPFSTÜTZE, UND FUSSSTÜTZE, STERNFUSS MIT ARRETIERBARE PUMPE GARANTIE 5 JAHREN



COD. 47RP.103

- RECLINABILE, POGGIATESTA REGOLABILE IN ALTEZZA, POGGIAPIEDI, BASE DISCO CON POMPA IDRAULICA BLOCCABILE 5 ANNI GARANZIA.
- RECLINABLE, HEIGHT ADJUSTABLE HEADREST, FOOTREST, DISCO BASE WITH LOCKABLE PUMP 5 YEARS WARRANTY
- INCLINABLE, APPUI-TÊTE REGLABLE EN HAUTEUR, REPOSE-PIEDS, BASE DISCO AVEC POMPE HYDRAULIQUE BLOCABLE GARANTIE 5 ANS.
- KIPPBARES, VERSTELLBARE KOPFSTÜTZE, UND FUSSSTÜTZE, TELLERFUSS MIT ARRETIERBARE PUMPE GARANTIE 5 JAHREN

COD. SPECIAL

- SKAI SPECIAL
- SKAI SPECIAL
- SKAI SPÉCIAL
- SKAI SPECIAL

ACCESSORI PER TUTTE LE POLTRONE UOMO
ACCESSORIES FOR MEN CHAIRS
ACCESSOIRES FAUTEUILS HOMMES
ZUBEHÖR FÜR ALLE DIE HERRENSTÜHLEN



COD. 152

- SCIVOLO LAVATESTA (TRANNE TATÙ)
- BLACK PLASTIC GROOVE FOR BARBER CHAIRS (NOT FOR TATÙ)
- CUVETTE PLASTIQUE POUR FAUTEUILS MESSIEURS (SAUF QUE TATÙ)
- BECKEN AUS KUNSTSTOFF (AUSSEER TATU')



COD. 153

- CUSCINO PER BAMBINI CM 41,5 X 30,5 H. CM 23
- CHILDREN'S CUSHION CM 41,5 X 30,5 H. CM 23
- COUSSIN ENFANTS CM 41,5 X 30,5 H. CM 23
- KINDERKISSEN CM 41,5 X 30,5 H. CM 23

COD. SPECIAL

- SKAI SPECIAL PER CUSCINO COD. 153
- SKAI SPECIAL FOR CUSHION COD. 153
- SKAI SPÉCIAL COUSSIN COD. 153
- SKAI SPECIAL FÜR KISSEN COD. 153

CLICHE' EMBOSSING



- REALIZZAZIONE CLICHÉ PER EMBOSSING PERSONALIZZATO.
- PERSONALIZED CLICHE FOR EMBOSSING.
- REALISATION CLICHÉ POUR EMBOSSING PERSONALISÉ.
- KLISCHEE REALISIERUNG FÜR PERSONALISIERTE EMBOSSING.



- STAMPA EMBOSSING SINGOLA.
- SINGLE EMBOSSING PRINTING.
- IMPRESSION EMBOSSING UNIQUE.
- EINZELN EMBOSSING AUSDRUCK.

SGABELLI STOOLS TABOURETS HOCKER

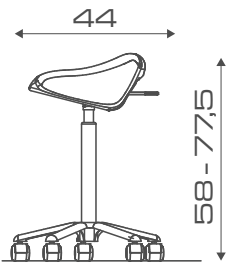

- SGABELLI CON POMPA A GAS ALTA, CONSIGLIATI PER RECEPTION E ZONE TAGLIO
- STOOLS WITH HIGH GAS PUMP, SUGGESTED FOR RECEPTION AND CUTTING AREA
- TABOURETS AVEC POMPE A GAS HAUTE, RECOMMANDÉ POUR RECEPTION ET ZONE COIFFAGE
- HOCKER MIT HOCH GASPUMPE, EMPFOHLEN FÜR RECEPTION UND HAARSCHNITT ZONE

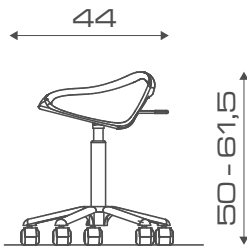

- SGABELLI CON POMPA A GAS MEDIA, CONSIGLIATI PER OPERATORI AL LAVATESTA E ZONE TAGLIO
- STOOLS WITH MEDIUM GAS PUMP, SUGGESTED FOR WASH UNITS OPERATORS AND CUTTING AREA
- TABOURETS AVEC POMPE A GAS MOYENNE, RECOMMANDÉS POUR OPERATEURS BAC DE LAVAGE ET ZONE COIFFAGE.
- HOCKER MIT MITTEL GASPUMPE, EMPFOHLEN FÜR WASCHANLAGE BETRIEBER UND HAARSCHNITT ZONE

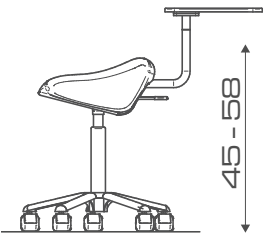

- SGABELLI CON POMPA A GAS BASSA, CONSIGLIATI PER OPERATORI MANICURE E PEDICURE
- STOOLS WITH LOW GAS PUMP, SUGGESTED FOR MANICURE AND PEDICURE.
- TABOURETS AVEC POMPE A GAS BAS, RECOMMANDÉS POUR MANICURE ET PEDICURE.
- HOCKER MIT NIEDRIGE GASPUMPE, EMPFOHLEN FÜR MANIKÜRE UND PEDIKÜRE BETRIEBER



150.CR

- DISPONIBILE ANCHE CON BASE NERA IN PLASTICA
- ALSO AVAILABLE WITH PLASTIC BLACK BASE
- DISPONIBLE AVEC PIÈTEMENT NOIR EN PLASTIQUE
- VERFÜGBAR AUCH MIT SCHWARZEM FUSS AUS KUNSTSTOFF



COD. 945

- PRODOTTI
- PRODUCTS
- PRODUITS
- PRODUKTEN

- ACCESSORI
- ACCESSORIES
- ACCESSOIRES
- ZUBEHÖR

COD. 150.CR

- SGABELLO SENZA SCHIENALE, BASE CROMATA
- CUTTING STOOL WITHOUT BACKREST, CHROMED STARBASE
- TABOURET DE COUPE SANS DOSSIER, BASE CHROMÉE
- HOCKER OHNE RÜCKENLEHNE, VERCHROMTER FUSS

COD. 150

- CON BASE NERA IN PLASTICA.
- WITH PLASTIC BLACK BASE.
- AVEC PIÈTEMENT NOIR EN PLASTIQUE.
- MIT SCHWARZEM FUSS AUS KUNSTSTOFF.

COD. SPECIAL

- SKAI SPECIAL
- SKAI SPÉCIAL
- SKAI SPÉCIAL
- SKAI SPECIAL

COD. 945

- KIT 5 RUOTE PIVOTANTI TRASPARENTI E RIMOVIBILI.
- KIT OF 5 TRANSPARENT PIVOTING CASTORS
- KIT 5 ROULETTES PIVOTANTS TRANSPARENTES REMOVIBLES
- 5 ROLLEN KIT, PIVOTANT TRANSPARENT UND BEWEGLICHEN.

151.CR

- DISPONIBILE ANCHE CON BASE NERA IN PLASTICA
- ALSO AVAILABLE WITH PLASTIC BLACK BASE
- DISPONIBLE AVEC PIÈTEMENT NOIR EN PLASTIQUE
- VERFÜGBAR AUCH MIT SCHWARZEM FUSS AUS KUNSTSTOFF



COD. 945

- PRODOTTI
- PRODUCTS
- PRODUITS
- PRODUKTEN

- ACCESSORI
- ACCESSORIES
- ACCESSOIRES
- ZUBEHÖR

COD. 151.CR

- SGABELLO CON SCHIENALE, BASE CROMATA
- CUTTING STOOL WITH BACKREST, CHROMED STARBASE
- TABOURET DE COUPE AVEC DOSSIER, BASE CHROMÉE
- HOCKER MIT RÜCKENLEHNE, VERCHROMTER FUSS

COD. 151

- CON BASE NERA IN PLASTICA.
- WITH PLASTIC BLACK BASE.
- AVEC PIÈTEMENT NOIR EN PLASTIQUE.
- MIT SCHWARZEM FUSS AUS KUNSTSTOFF.

COD. SPECIAL

- SKAI SPECIAL
- SKAI SPÉCIAL
- SKAI SPÉCIAL
- SKAI SPECIAL

COD. 945

- KIT 5 RUOTE PIVOTANTI TRASPARENTI E RIMOVIBILI.
- KIT OF 5 TRANSPARENT PIVOTING CASTORS
- KIT 5 ROULETTES PIVOTANTS TRANSPARENTES REMOVIBLES
- 5 ROLLEN KIT, PIVOTANT TRANSPARENT UND BEWEGLICHEN.

GLIDE



COD. 945

- PRODOTTI
- PRODUCTS
- PRODUITS
- PRODUKTEN

- ACCESSORI
- ACCESSORIES
- ACCESSOIRES
- ZUBEHÖR

COD. 198

- SGABELLO CON SCHIENALE E CON BASE ALLUMINIO MINI.
- CUTTING STOOL WITH BACKREST, SMALL ALUMINIUM STARBASE.
- TABOURET DE COUPE AVEC DOSSIER ET PETIT-ALU BASE.
- HOCKER MIT RÜCKENLEHNE, ALU FUSS.

COD. SPECIAL

- SKAI SPECIAL
- SKAI SPÉCIAL
- SKAI SPÉCIAL
- SKAI SPECIAL

COD. 945

- KIT 5 RUOTE PIVOTANTI TRASPARENTI E RIMOVIBILI.
- KIT OF 5 TRANSPARENT PIVOTING CASTORS
- KIT 5 ROULETTES PIVOTANTS TRANSPARENTES REMOVIBLES
- 5 ROLLEN KIT, PIVOTANT TRANSPARENT UND BEWEGLICHEN.

ARIET



COD. 945



COD. 197

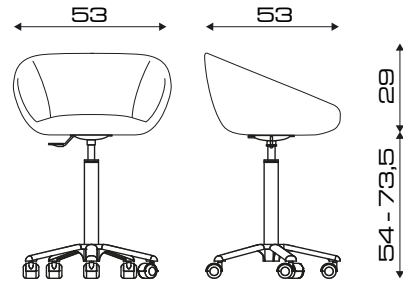

- ALTO (STANDARD)
- HIGH (STANDARD)
- HAUT (STANDARD)
- HOCH (STANDARD)

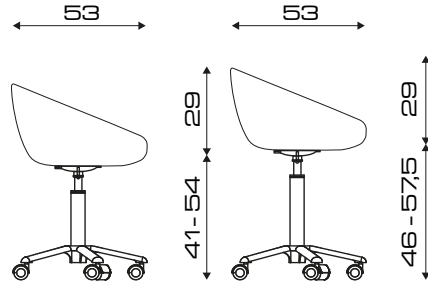

- BASSO
- LOW
- BAS
- NIEDRIG

- MEDIO
- MEDIUM
- MÉDIANE
- MITTEL

- PRODOTTI
- PRODUCTS
- PRODUITS
- PRODUKTEN

- ACCESSORI
- ACCESSORIES
- ACCESSOIRES
- ZUBEHÖR

COD. SPECIAL

- SKAI SPECIAL
- SKAI SPECIAL
- SKAI SPÉCIAL
- SKAI SPECIAL

COD. 945

- KIT 5 RUOTE PIVOTANTI TRASPARENTI E RIMOVIBILI.
- KIT OF 5 TRANSPARENT PIVOTING CASTORS
- KIT. 5 ROULETTES PIVOTANTS TRANSPARENTES REMOVIBLES.
- 5 ROLLEN KIT, PIVOTANT TRANSPARENT UND BEWEGLICHEN.



COD. 197

- SGABELLO CON BASE ALLUMINIO MINI.
- STOOL WITH ALUMINIUM SMALL STARBASE.
- TABOURET AVEC PETIT-ALU BASE.
- HOCKER MIT ALU FUSS.

DEE



COD. 945



COD. 195



- ALTO (STANDARD)
- HIGH (STANDARD)
- HAUT (STANDARD)
- HOCH (STANDARD)

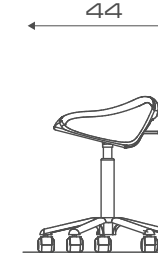

- MEDIO
- MEDIUM
- MÉDIANE
- MITTEL

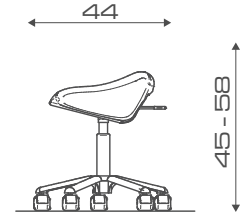

- BASSO
- LOW
- BAS
- NIEDRIG

COD. 945

- PRODOTTI
- PRODUCTS
- PRODUITS
- PRODUKTEN



COD. 195

- SGABELLO CON BASE ALLUMINIO MINI.
- STOOL WITH SMALLER GAS LIFT ALUMINIUM BASE.
- TABOURET AVEC PETIT ALU-BASE
- HOCKER MIT ALU FUSS



COD. 196

- SGABELLO CON BASE ALLUMINIO MINI E PIANO LAVORO
- STOOL WITH SMALLER GAS LIFT ALUMINIUM BASE AND TECHNICAL TRAY.
- TABOURET AVEC PLATEAU TECHNIQUE ET PETIT ALU-BASE.
- HOCKER MIT TRAY UND ALU FUSS.

DEE TRAY



COD. 945



COD. 196

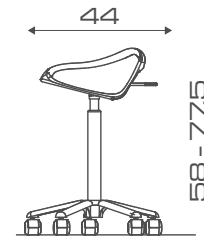

- ALTO
- HIGH
- HAUT
- HOCH



- MEDIO (STANDARD)
- MEDIUM (STANDARD)
- MÉDIANE (STANDARD)
- MITTEL (STANDARD)

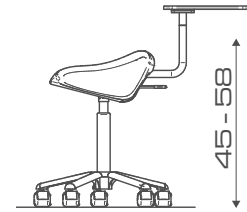

- BASSO
- LOW
- BAS
- NIEDRIG

- ACCESSORI
- ACCESSORIES
- ACCESSOIRES
- ZUBEHÖR

COD. SPECIAL

- SKAI SPECIAL
- SKAI SPECIAL
- SKAI SPÉCIAL
- SKAI SPECIAL

COD. 945

- KIT 5 RUOTE PIVOTANTI TRASPARENTI E RIMOVIBILI.
- KIT OF 5 TRANSPARENT PIVOTING CASTORS
- KIT 5 ROULETTES PIVOTANTS TRANSPARENTES REMOVIBLES
- 5 ROLLEN KIT, PIVOTANT TRANSPARENT UND BEWEGLICHEN.

LEAF

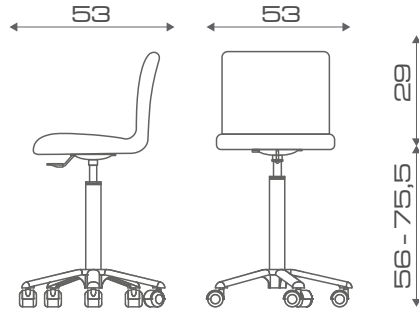

- ALTO (STANDARD)
- HIGH (STANDARD)
- HAUT (STANDARD)
- HOCH (STANDARD)

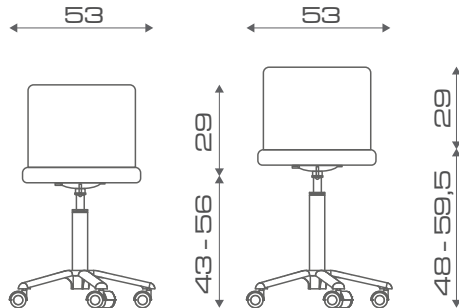

- BASSO
- LOW
- BAS
- NIEDRIG

- MEDIO
- MEDIUM
- MÉDIANE
- MITTEL



COD. 945



- PRODOTTI
- PRODUCTS
- PRODUITS
- PRODUKTEN

- ACCESSORI
- ACCESSORIES
- ACCESSOIRES
- ZUBEHÖR

RIDER



COD. 945



COD. 191

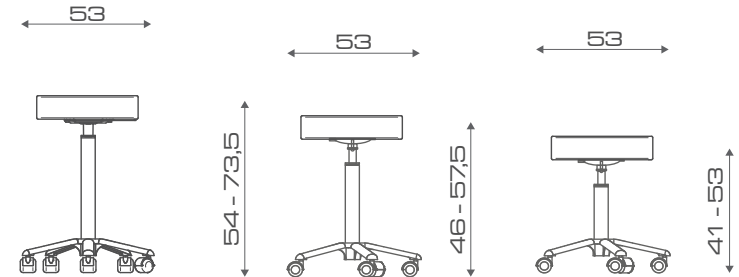

- ALTO
- HIGH
- HAUT
- HOCH

- MEDIO (STANDARD)
- MEDIUM (STANDARD)
- MÉDIANE (STANDARD)
- MITTEL (STANDARD)

- BASSO
- LOW
- BAS
- NIEDRIG

RIDER TRAY



COD. 945



COD. 194

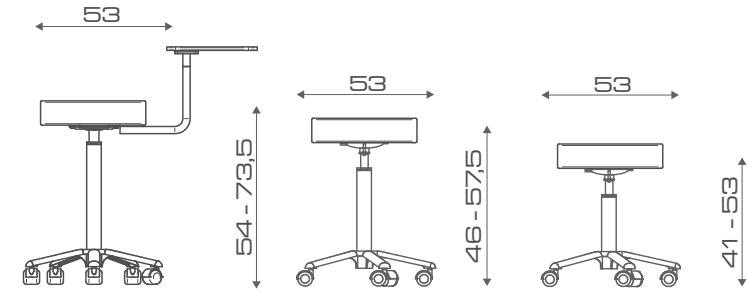

- ALTO
- HIGH
- HAUT
- HOCH

- MEDIO (STANDARD)
- MEDIUM (STANDARD)
- MÉDIANE (STANDARD)
- MITTEL (STANDARD)

- BASSO
- LOW
- BAS
- NIEDRIG

- PRODOTTI
- PRODUCTS
- PRODUITS
- PRODUKTEN

- ACCESSORI
- ACCESSORIES
- ACCESSOIRES
- ZUBEHÖR

COD. SPECIAL

- SKAI SPECIAL
- SKAI SPECIAL
- SKAI SPÉCIAL
- SKAI SPECIAL

COD. 945

- KIT 5 RUOTE PIVOTANTI TRASPARENTI E RIMOVIBILI.
- KIT OF 5 TRANSPARENT PIVOTING CASTORS.
- KIT 5 ROULETTES PIVOTANTS TRANSPARENTES REMOVIBLES.
- 5 ROLLEN KIT, PIVOTANT TRANSPARENT UND BEWEGLICHEN.



COD. 192

- SGABELLO CON BASE ALLUMINIO MINI.
- STOOL WITH SMALLER GAS LIFT ALUMINIUM BASE.
- TABOURET AVEC PETIT ALU-BASE
- HOCKER MIT ALU FUSS



COD. 191

- SGABELLO CON BASE ALLUMINIO MINI.
- STOOL WITH SMALLER GAS LIFT ALUMINIUM BASE.
- TABOURET AVEC PETIT ALU-BASE
- HOCKER MIT ALU FUSS



COD. 194

- SGABELLO CON BASE ALLUMINIO MINI E PIANO LAVORO.
- STOOL WITH SMALLER GAS LIFT ALUMINIUM BASE AND TECHNICAL TRAY.
- TABOURET AVEC PLATEAU TECHNIQUE ET PETIT ALU-BASE.
- HOCKER MIT TRAY UND ALU FUSS.

COD. SPECIAL

- SKAI SPECIAL
- SKAI SPECIAL
- SKAI SPÉCIAL
- SKAI SPECIAL

COD. 945

- KIT 5 RUOTE PIVOTANTI TRASPARENTI RIMOVIBILI.
- KIT OF 5 TRANSPARENT PIVOTING CASTORS.
- KIT 5 ROULETTES PIVOTANTS TRANSPARENTES REMOVIBLES.
- 5 ROLLEN KIT, PIVOTANT TRANSPARENT UND BEWEGLICHEN.

LAVAGGI HEAD-SPA HEAD-SPA BACKWASH UNITS BACS DE LAVAGE HEAD-SPA WASCHANLAGEN HEAD-SPA

IT I LAVAGGI HEAD SPA PIETRANERA NASCONO DALL'ESIGENZA DEI SALONI DI AMPLIARE IL NUMERO E IL LIVELLO QUALITATIVO DEI SERVIZI, TRASFORMANDO IL MOMENTO DEL "LAVAGGIO DEI CAPELLI" IN UN'ESPERIENZA DI BENESSERE E DI BELLEZZA UNICA PER IL CLIENTE. NEGLI ULTIMI ANNI IN PARTICOLARE, SEMPRE PIÙ PERSONE, (DONNE, UOMINI, GIOVANI, ADULTI ED ANCHE ANZIANI) RICERCANO E SONO DISPOSTI A DEDICARE PARTE DEL PROPRIO TEMPO AL BENESSERE PERSONALE, PER RITROVARE QUELL'EQUILIBRIO E SENSO DI ARMONIA PSICO-FISICO CHE È ALLA BASE DEL BENESSERE E DELLA SALUTE PER OGNI INDIVIDUO.

EN PIETRANERA HEAD SPA BACKWASHES WERE CREATED FROM THE NEED OF SALONS TO EXPAND THE NUMBER AND LEVEL OF QUALITY OF SERVICES, TRANSFORMING THE HAIR WASHING MOMENT INTO A UNIQUE WELLNESS AND BEAUTY EXPERIENCE FOR EACH CUSTOMER. IN RECENT YEARS, MORE AND MORE PEOPLE, (WOMEN, MEN, YOUNG PEOPLE, ADULTS AND EVEN THE ELDERLY) ARE SEEKING AND ARE WILLING TO DEVOTE PART OF THEIR TIME TO PERSONAL WELLBEING, TO REACH BALANCE AND A SENSE OF MENTAL AND PHYSICAL HARMONY THAT IS AT THE BASIS OF WELL-BEING AND HEALTH FOR EVERY INDIVIDUAL.

FR LES LITS DE LAVAGE HEAD SPA PIETRANERA SONT NÉS DE LA NÉCESSITÉ POUR LES SALONS D'ÉLARGIR LE NOMBRE ET LE NIVEAU DE QUALITÉ DES SERVICES, EN TRANSFORMANT LE MOMENT DU « LAVAGE DES CHEVEUX » EN UNE EXPÉRIENCE UNIQUE DE BIEN-ÊTRE ET DE BEAUTÉ POUR LE CLIENT. CES DERNIÈRES ANNÉES EN PARTICULIER, DE PLUS EN PLUS DE PERSONNES (FEMMES, HOMMES, JEUNES, ADULTES ET MÊME PERSONNES ÂGÉES) RECHERCHENT ET SOUHAISENT CONSACRER UNE PARTIE DE LEUR TEMPS À LEUR PROPRE BIEN-ÊTRE, POUR RETROUVER CET ÉQUILIBRE ET CE SENTIMENT D'HARMONIE PSYCHOPHYSIQUE QUI SONT À LA BASE DU BIEN-ÊTRE ET DE LA SANTÉ DE CHAQUE INDIVIDU.

DE HEAD SPA PIETRANERA WASCHANLAGEN ENTSTEHEN AUS DEM BEDÜRFNIS DER SALONS, DIE ANZAHL UND DAS QUALITÄTSNIVEAU DER DIENSTLEISTUNGEN ZU ERHÖHEN, INDEM SIE DEN MOMENT DES "HAAREWASCHENS" IN EIN EINZIGARTIGES WELLNESS- UND SCHÖNHEITSERLEBNIS FÜR JEDEN KUNDEN. VOR ALLEM IN DEN LETZTEN JAHREN IMMER MEHR MENSCHEN (FRAUEN, MÄNNER, JUNGE MENSCHEN UND SOGAR ÄLTERE MENSCHEN) SUCHEN UND BEREIT SIND, EINEN TEIL IHRER ZEIT DEM PERSÖNLICHEN WOHLBEFINDEN ZU WIDMEN, UM DAS GLEICHGEWICHT UND DAS GEFÜHL DER HARMONIE WIEDERZUERLANGEN DIE DIE GRUNDLAGE FÜR DAS WOHLBEFINDEN UND DIE GESUNDHEIT EINES JEDEN INDIVIDUUM IST.



FABLE



COD. 550 + MOT + THERMIC + BOT + LED

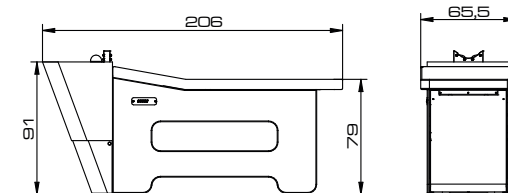

COD. 155

- TRAY-REGULAR CON CIOTOLE
- TRAY-REGULAR WITH BOWLS
- TRAY-REGULAR AVEC BOLS
- TRAY-REGULAR MIT 2 SCHÜSSELN



COD. 156

- TRAY-LARGE CON CIOTOLE
- TRAY-LARGE WITH BOWLS
- TRAY-LARGE AVEC BOLS
- TRAY-LARGE MIT 2 SCHÜSSELN

VERSIONI - MODELS - VERSIONS - VERSIONEN

- COD. 550**
- LETTINO LAVAGGIO PER TRATTAMENTI, VASCA BIANCA IN CERAMICA E MISCELATORE CON FORCELLA.
 - WASHING & TREATMENT BED, WITH CERAMIC WHITE BASIN AND DRIP-PROOF MIXER.
 - ABLE SHAMPOOING ET SOINS, AVEC CLUVETTE BLANCHE EN CERAMIQUE ET MITTIGEUR ANTI-GOUTTE.
 - HAARWASCHLIEGE, WEISS KERAMIK BECKEN UND MISCHBATTERIE MIT DROP-STOP SYSTEM

• ACCESSORI - ACCESSORIES - ACCESSOIRES - ZUBEHÖR

- COD. MOT**
- SCHIENALE COMFORT CON ATTUATORE ELETTRICO, CON TELECOMANDO
 - "COMFORT" BACKREST WITH ELECTRIC MOTOR, WITH REMOTE CONTROL
 - DOSSIER "COMFORT" RÉGLABLE AVEC MOTEUR ÉLECTRIQUE ET TÉLÉCOMMANDE
 - COMFORT RÜCKENLEHNE MIT ELEKTRISCHE EINSTELLUNG, MIT FERNBEDIENUNG

- COD. THERMIC**
- RISCALDAMENTO MATERASSO, CON PANNELLO DI CONTROLLO
 - MATTRESS HEATING, WITH CONTROL BOARD
 - MATELAS CHAUFFANT, AVEC PANNEAU DE CONTRÔLE
 - BEHEIZTE MATRATZE MIT BEDIENFELD

- COD. MASSAGE**
- JET MASSAGE SU MATERASSO CON TELECOMANDO, DURATA MASSAGGIO 8/16 MIN.
 - JET MASSAGE ON MATTRESS WITH REMOTE CONTROL, MASSAGE DURATION 8/16 MIN.
 - JET MASSAGE SUR LE MATELAS AVEC TÉLÉCOMMANDE, DURÉE DU MASSAGE 8/16 MIN.
 - GANZKÖRPER JET MASSAGE MIT FERNBEDIENUNG, MASSAGEDAUER 8/16 MIN.

- COD. MASSAGE PLUS**
- JET MASSAGE SU MATERASSO CON TELECOMANDO, DURATA MASSAGGIO 16/24 MIN.
 - JET MASSAGE ON MATTRESS WITH REMOTE CONTROL, MASSAGE DURATION 16/24 MIN.
 - JET MASSAGE SUR LE MATELAS AVEC TÉLÉCOMMANDE, DURÉE DU MASSAGE 16/24 MIN.
 - GANZKÖRPER JET MASSAGE MIT FERNBEDIENUNG, MASSAGEDAUER 16/24 MIN.

- COD. SPECIAL**
- SKAI SPECIAL
 - SKAI SPECIAL
 - SKAI SPECIAL
 - SKAI SPECIAL

• ACCESSORI - ACCESSORIES - ACCESSOIRES - ZUBEHÖR

- COD. 155**
- TRAY-REGULAR TAVOLOZZA TRATTAMENTI COMPLETA DI CIOTOLE
 - TRAY-REGULAR, PALETTE FOR TREATMENTS COMPLETE WITH BOWLS
 - TRAY-REGULAR, PLATEAU POUR SOINS COMPLET AVEC BOLS
 - TRAY-REGULAR, PALETTE FÜR BEHANDLUNGEN MIT 2 SCHÜSSELN

- COD. 156**
- TRAY-LARGE TAVOLOZZA TRATTAMENTI COMPLETA DI CIOTOLE
 - TRAY-LARGE, PALETTE FOR TREATMENTS COMPLETE WITH BOWLS
 - TRAY-LARGE, PLATEAU POUR SOINS COMPLET AVEC BOLS
 - TRAY-LARGE, PALETTE FÜR BEHANDLUNGEN MIT 2 SCHÜSSELN

- COD. 465**
- SUPPLEMENTO MISCELATORE TERMOSTATICO CON FORCELLA.
 - EXTRA CHARGE FOR THERMOSTATIC WATER MIXER WITH DRIP-PROOF SHOWER.
 - SUPPLÉMENT MITIGEUR THERMOSTATIQUE AVEC SYSTÈME ANTI-ÉGOUTTEMENT.
 - AUFPREIS MISCHBATTERIE MIT THERMOSTAT UND ANTI-TROPFEN SYSTEM.

- COD. BOT**
- VERSIONE TIPO CAPITONNÉ SULLE SPALLE.
 - QUILTED UPHOLSTERING ON THE SIDES
 - SUPPLÉMENT POUR EFFET CAPITONNÉ SUR LES CÔTÉS
 - SEITLICHEN CAPITONNÉ' ENDBEARBEITUNG

FABLE



COD. 550



**COD. 550+MOT+LED
+MASSAGE+THERMIC+935**



**COD. 550+MOT+LED
+MASSAGE+THERMIC+936**



COD. 550 + MOT + THERMIC + BOT



COD. SOUND WASH



COD. NER



COD. N&B



COD. TRA



COD. 935 RAIN



COD. 936 ELIXIR

• ACCESSORI - ACCESSORIES - ACCESSOIRES - ZUBEHÖR

COD. SOUND WASH

- SISTEMA INTEGRATO DI DIFFUSIONE SONORA
- INTEGRATED SOUND SYSTEM
- SYSTÈME DE DIFFUSION SONORE INTÉGRÉ
- INTEGRIERTE BESCHALLUNGSANLAGE

COD. NER
COD. N&B
COD. TRA

- SUPPLEMENTO CERAMICA NERA O INTERNO BIANCO-ESTERNO NERO OPACO O INTERNO BIANCO-ESTERNO TRAVERTINO.
- EXTRA CHARGE FOR BLACK BASIN OR INTERIOR WHITE-EXTERIOR MATT BLACK OR INTERIOR WHITE-EXTERIOR TRAVERTINE.
- SUPPLÉMENT CUVETTE NOIRE OU INTÉRIEUR BLANC-EXTÉRIEUR NOIR MAT OU INTÉRIEUR BLANC-EXTÉRIEUR TRAVERTIN.
- AUFPREIS FÜR SCHWARZES WASCHBECKEN ODER INNEN WEISS, AUSSEN MATTSCHWARZ ODER INNEN WEISS, AUSSEN TRAVERTIN.

COD. 470

- PEDALIERA UP/DOWN - PER MOD.CON SCHIENALE COMFORT (MOT)
- UP/DOWN FOOT CONTROL FOR "COMFORT" VERSION (MOT)
- COMMANDE AU PIED UP/DOWN POUR VERSION "COMFORT" (MOT)
- FUSSPEDAL UP/DOWN FÜR "COMFORT" RÜCKENLEHNE

COD. 472

- PEDALIERA PER MODELLO JET MASSAGE.
- FOOT CONTROL FOR JET MASSAGE
- COMMANDE AU PIED POUR JET MASSAGE
- FUSSPEDAL FÜR MODELLE MIT JET MASSAGE

COD. LED

- OBLÒ LATERALI IN METACRILATO CON ILLUMINAZIONE LED
- SIDE WINDOWS IN ACRYLIC, WITH LED LIGHTING
- HUBLOTS LATÉRAUX EN PLEXIGLAS, AVEC ILLUMINATION À LED
- SEITLICHE FENSTER AUS METHACRYLAT, MIT LED BELEUCHTUNG

COD. 935 RAIN

- GRUPPO DOCCIA CASCATA
- WATERFALL SHOWER KIT
- KIT DE DOUCHE CASCADE
- WASSERFALL DUSCHSET

COD. 936 ELIXIR

- KIT SHIRODHARA, INTERNO VASCA, COMPLETO DI VASCA IN PLASTICA PER RECUPERO OLIO
- KIT SHIRODHARA, INSIDE BASIN, WITH PLASTIC BOLS FOR OIL RECOVERY.
- KIT SHIRODHARA, INTÉRIEUR CUVETTE, COMPLET DE BOL PLASTIQUE POUR LA RÉCOLTE DE L'HUILE.
- KIT SHIRODHARA, IM WASCHBECKEN, KOMPLETT MIT KUNSTSTOFFWANNE ZUR OLRÜCKGEWINNUNG

COD. M0/550

- FODERINA SCHIENALE
- BACKREST COVER
- HOUSSE DE PROTECTION DOSSIER
- SCHUTZHÜLLE FÜR RÜCKENLEHNE

COD. 9023

- PORTAROTOLO PER LETTO.
- PAPER-ROLL HOLDER FOR BED
- PORTE ROULEAU POUR TABLE
- HALTER FÜR PAPIERROLLE

FABLE

- ACCESSORI
- ACCESSORIES
- ACCESSOIRES
- ZUBEHÖR



COD. 664

- CARRELLO IN LEGNO CON RUOTE E STRUTTURA DI CONTENIMENTO, PER LETTINO FABLE.
- WOODEN TROLLEY ON WHEELS WITH CONTAINMENT STRUCTURE, FOR FABLE.
- CHARIOT EN BOIS AVEC ROULETTES ET STRUCTURE CONTENITIVE POUR FABLE.
- ARBEITSWAGEN, FÜR FABLE, AUS HOLZ MIT ROLLEN



COD. 693

- PREDELLINO PER ZEN VERNICIATO BIANCO
- STEP LADDER FOR ZEN WHITE PAINTED
- PETIT ESCALIER POUR ZEN VERNI EN BLANC
- TRITTBRETT FÜR ZEN WEISS LACKIERT

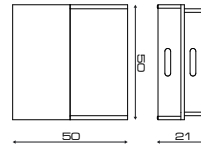

COD. 107.1

- CUSCINO POGGIA TESTA CON FORO VISO IN MEMORY FOAM.
- MEMORY FOAM HEADREST PILLOW WITH FACE HOLE.
- REPOSE TÊTE EN MOUSSE MÉMOIRE AVEC TROU FACIAL
- KOPFSTÜTZENKISSEN MIT PLATZ FÜR GESICHT AUS "MEMORY FOAM"

COD. SPECIAL

- SKAI SPECIAL
- SKAI SPECIAL
- SKAI SPECIAL
- SKAI SPECIAL

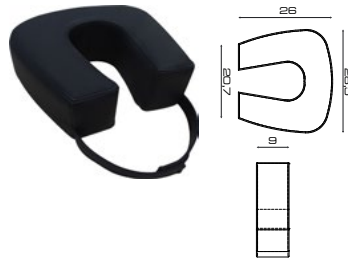

COD. 107.2

- CUSCINO CILINDRICO PER GINOCCHIA IN MEMORY FOAM.
- MEMORY FOAM CYLINDRIC PILLOW RESTING KNEES.
- COUSSIN CYLINDRIQUE POUR LES GENOUX EN MOUSSE MÉMOIRE.
- ZILYNDERFÖRMIGES KISSEN FÜR DIE KNEE AUS "MEMORY FOAM"

COD. SPECIAL

- SKAI SPECIAL
- SKAI SPECIAL
- SKAI SPECIAL
- SKAI SPECIAL

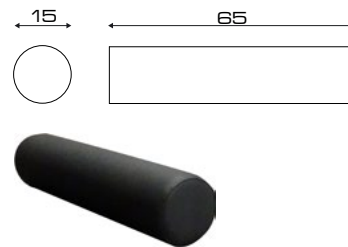

COD. 107.3

- CUSCINO SEMICILINDRICO PER GINOCCHIA IN MEMORY-FOAM
- MEMORY FOAM SEMI-CYLINDRICAL PILLOW RESTING KNEES.
- COUSSIN SEMI-CYLINDR. POUR LES GENOUX EN MOUSSE MÉMOIRE
- HALBZILYNDRISCHES KISSEN FÜR DIE KNEE AUS "MEMORY FOAM"

COD. SPECIAL

- SKAI SPECIAL
- SKAI SPECIAL
- SKAI SPECIAL
- SKAI SPECIAL

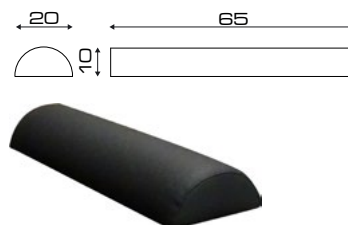

COD. 107.4

- CUSCINO SEMICILINDRICO POGGIA TESTA IN MEMORY-FOAM.
- MEMORY FOAM SEMI-CYLINDRICAL HEADREST PILLOW.
- REPOSE TÊTE SEMI-CYLINDRIQUE EN MOUSSE MÉMOIRE..
- HALBZILYNDRISCHES KISSEN FÜR DEN KOPF AUS "MEMORY FOAM"

COD. SPECIAL

- SKAI SPECIAL
- SKAI SPECIAL
- SKAI SPECIAL
- SKAI SPECIAL

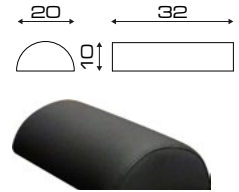

COD. 107.5

- CUSCINO A TRAPEZIO IN MEMORY FOAM.
- MEMORY FOAM TRAPEZOIDAL PILLOW.
- COUSSIN TRAPEZOÏDALE EN MOUSSE MÉMOIRE.
- TRAPEZ- KISSEN AUS "MEMORY FOAM"

COD. SPECIAL

- SKAI SPECIAL
- SKAI SPECIAL
- SKAI SPECIAL
- SKAI SPECIAL

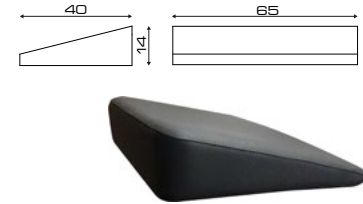

COD. 939

- CASCATA COMPLETA DI DIFFUSORE E DOCCETTA "PERFORMANCE" IN SILICONE NERO - (ATTENZIONE: CON QUESTO PRODOTTO NON SONO UTILIZZABILI I TRAY 155 E 156).
- WATERFALL COMPLETE WITH DIFFUSER AND BLACK SOLICONE "PERFORMANCE" HAND SHOWER. - (ATTENTION: TRAYS 155 AND 156 CANNOT BE USED WITH THIS PRODUCT).
- CASCADE COMPLÈTE AVEC DIFFUSEUR ET DOUCHETTE "PERFORMANCE" EN SILICONE NOIR.- (ATTENTION : LES TRAYS 155 AND 156 NE PEUVENT PAS ÊTRE UTILISÉS AVEC CE PRODUIT)
- WASSERFALL KOMPLETT MIT DIFFUSOR UND SCHWARZER SILIKONHANDBRAUSE "PERFORMANCE". - VORSICHT: DIE TABLETS 155 UND 156 KÖNNEN NICHT MIT DIESEM PRODUKT VERWENDET WERDEN).



COD. 937

- ELIXIR - SHIRODHARA CON BASE GIREVOLE IN ALLUMINIO VERNICIATO NERA COMPLETO DI VASCA IN PLASTICA PER RECUPERO OLIO.
- ELIXIR - SHIRODHARA WITH SWIVEL BASE IN BLACK PAINTED ALUMINIUM WITH PLASTIC BOLS FOR OIL RECOVERY.
- ELIXIR - SHIRODHARA AVEC PIED PIVOTANT EN ALUMINIUM PEINT EN NOIR COMPLET DE BOL PLASTIQUE POUR LA RÉCOLTE DE L'HUILE.
- ELIXIR - SHIRODHARA MIT DREHBARER FUSS AUS SCHWARZ LACKIERTEM ALUMINIUM KOMPLETT MIT KUNSTSTOFFWANNE ZUR OLRUCKGEWINNUNG.



FABLE LIFT



Carsat



UP/DOWN

COD. 551 + THERMIC + MASSAGE

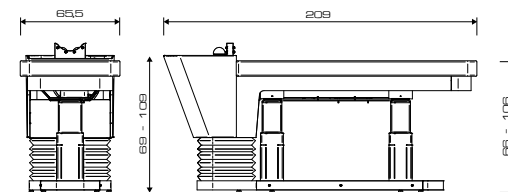

COD. 155

- TRAY-REGULAR CON CIOTOLE
- TRAY-REGULAR WITH BOWLS
- TRAY-REGULAR AVEC BOLS
- TRAY-REGULAR MIT 2 SCHÜSSELN



COD. 156

- TRAY-LARGE CON CIOTOLE
- TRAY-LARGE WITH BOWLS
- TRAY-LARGE AVEC BOLS
- TRAY-LARGE MIT 2 SCHÜSSELN

VERSIONI - MODELS - VERSIONS - VERSIONEN

- COD. 551**
- LETTINO LAVAGGIO PER TRATTAMENTI, MOVIMENTO VERTICALE MOTORIZZATO DELLA STRUTTURA CON PEDALIERA "UP/DOWN", VASCA BIANCA IN CERAMICA E MISCELATORE CON FORCELLA.
 - WASHING & TREATMENT BED, MOTORISED VERTICAL MOVEMENT OF THE STRUCTURE WITH "UP/DOWN" FOOT CONTROL, CERAMIC WHITE BASIN AND DRIP-PROOF MIXER
 - TABLE SHAMPOOING ET SOINS, MOUVEMENT VERTICAL MOTORISÉ DE LA STRUCTURE AVEC COMMANDE AU PIED "UP/DOWN", CUVETTE BLANCHE EN CERAMIQUE ET MITIGEUR ANTI-GOUTTE
 - HAARWASCHLIEGE, VERTIKALE MOTORISIERTER BEWEGUNG VON DER STRUKTUR MIT FUSSPEDAL "UP/DOWN", WEISS KERAMIK BECKEN UND MISCHBATTERIE MIT DROP-STOP SYSTEM

• ACCESSORI - ACCESSORIES - ACCESSOIRES - ZUBEHÖR

- COD. MOT**
- SCHIENALE COMFORT CON ATTUATORE ELETTRICO, CON TELECOMANDO
 - "COMFORT" BACKREST WITH ELECTRIC MOTOR, WITH REMOTE CONTROL
 - DOSSIER "COMFORT" RÉGLABLE AVEC MOTEUR ÉLECTRIQUE ET TÉLÉCOMMANDE
 - COMFORT RÜCKENLEHNE MIT ELEKTRISCHE EINSTELLUNG, MIT FERNBEDIENUNG

- COD. THERMIC**
- RISCALDAMENTO MATERASSO, CON PANNELLO DI CONTROLLO
 - MATTRESS HEATING, WITH CONTROL BOARD
 - MATELAS CHAUFFANT, AVEC PANNEAU DE CONTRÔLE
 - BEHEIZTE MATRATZE MIT BEDIENFELD

- COD. MASSAGE**
- JET MASSAGE SU MATERASSO CON TELECOMANDO, DURATA MASSAGGIO 8/16 MIN.
 - JET MASSAGE ON MATTRESS WITH REMOTE CONTROL, MASSAGE DURATION 8/16 MIN.
 - JET MASSAGE SUR LE MATELAS AVEC TÉLÉCOMMANDE, DURÉE DU MASSAGE 8/16 MIN.
 - GANZKÖRPER JET MASSAGE MIT FERNBEDIENUNG, MASSAGEDAUER 8/16 MIN.

- COD. MASSAGE PLUS**
- JET MASSAGE SU MATERASSO CON TELECOMANDO, DURATA MASSAGGIO 16/24 MIN.
 - JET MASSAGE ON MATTRESS WITH REMOTE CONTROL, MASSAGE DURATION 16/24 MIN.
 - JET MASSAGE SUR LE MATELAS AVEC TÉLÉCOMMANDE, DURÉE DU MASSAGE 16/24 MIN.
 - GANZKÖRPER JET MASSAGE MIT FERNBEDIENUNG, MASSAGEDAUER 16/24 MIN.

• ACCESSORI - ACCESSORIES - ACCESSOIRES - ZUBEHÖR

- COD. SPECIAL**
- SKAI SPECIAL
 - SKAI SPECIAL
 - SKAI SPECIAL
 - SKAI SPECIAL

- COD. 155**
- TRAY-REGULAR TAVOLOZZA TRATTAMENTI COMPLETA DI CIOTOLE
 - TRAY-REGULAR, PALETTE FOR TREATMENTS COMPLETE WITH BOWLS
 - TRAY-REGULAR, PLATEAU POUR SOINS COMPLET AVEC BOLS
 - TRAY-REGULAR, PALETTE FÜR BEHANDLUNGEN MIT 2 SCHÜSSELN

- COD. 156**
- TRAY-LARGE TAVOLOZZA TRATTAMENTI COMPLETA DI CIOTOLE
 - TRAY-LARGE, PALETTE FOR TREATMENTS COMPLETE WITH BOWLS
 - TRAY-LARGE, PLATEAU POUR SOINS COMPLET AVEC BOLS
 - TRAY-LARGE, PALETTE FÜR BEHANDLUNGEN MIT 2 SCHÜSSELN

- COD. 465**
- SUPPLEMENTO MISCELATORE TERMOSTATICO CON FORCELLA.
 - EXTRA CHARGE FOR THERMOSTATIC WATER MIXER WITH DRIP-PROOF SHOWER.
 - SUPPLEMENT MITIGEUR THERMOSTATIQUE AVEC SYSTÈME ANTI-ÉGOUTTEMENT.
 - AUFPREIS MISCHBATTERIE MIT THERMOSTAT UND ANTI-TROPFEN SYSTEM.

FABLE LIFT

Carsat



**COD. 551+THERMIC
+MASSAGE +COD. 935**

**COD. 551+THERMIC
+ MASSAGE +COD. 936**



**COD. 551+MOT
+THERMIC+MASSAGE**



COD. SOUND WASH



COD. NER



COD. N&B



COD. TRA



COD. 935 RAIN



COD. 936 ELIXIR

• ACCESSORI - ACCESSORIES - ACCESSOIRES - ZUBEHÖR

• ACCESSORI - ACCESSORIES - ACCESSOIRES - ZUBEHÖR

COD. SOUND WASH

- SISTEMA INTEGRATO DI DIFFUSIONE SONORA
- INTEGRATED SOUND SYSTEM
- SYSTÈME DE DIFFUSION SONORE INTÉGRÉ
- INTEGRIERTE BESCHALLUNGSANLAGE

COD. 472

- PEDALIERA PER MODELLO JET MASSAGE.
- FOOT CONTROL FOR JET MASSAGE
- COMMANDE AU PIED POUR JET MASSAGE
- FUSSPEDAL FÜR MODELLE MIT JET MASSAGE

COD. NER
COD. N&B
COD. TRA

- SUPPLEMENTO CERAMICA NERA O INTERNO BIANCO-ESTERNO NERO OPACO O INTERNO BIANCO-ESTERNO TRAVERTINO.
- EXTRA CHARGE FOR BLACK BASIN OR INTERIOR WHITE-EXTERIOR MATT BLACK OR INTERIOR WHITE-EXTERIOR TRAVERTINE.
- SUPPLÉMENT CUVETTE NOIRE OU INTÉRIEUR BLANC-EXTÉRIEUR NOIR MAT OU INTÉRIEUR BLANC-EXTÉRIEUR TRAVERTIN.
- AUFPREIS FÜR SCHWARZES WASHBECKEN ODER INNEN WEISS, AUSSEN MATTSCHWARZ ODER INNEN WEISS, AUSSEN TRAVERTIN.

COD. 9023

- PORTAROTOLO PER LETTO.
- PAPER-ROLL HOLDER FOR BED
- PORTE ROULEAU POUR TABLE
- HALTER FÜR PAPIERROLLE

COD. 935

- RAIN - GRUPPO DOCCIA CASCATA
- RAIN - WATERFALL SHOWER KIT
- RAIN - KIT DE DOUCHE CASCADE
- RAIN - WASSERFALL DUSCHSET

COD. 936

- KIT SHIRODHARA, INTERNO VASCA, COMPLETO DI VASCA IN PLASTICA PER RECUPERO OLIO.
- KIT SHIRODHARA, INSIDE BASIN, WITH PLASTIC BOLS FOR OIL RECOVERY.
- KIT SHIRODHARA, INTERIEUR CUVETTE, COMPLET DE BOL PLASTIQUE POUR LA RÉCOLTE DE L'HUILE.
- KIT SHIRODHARA, IM WASHBECKEN, KOMPLETT MIT KUNSTSTOFFWANNE ZUR OLRUCKGEWINNUNG.

COD. M0/550B

- FODERINA SCHIENALE
- BACKREST COVER
- HOUSSE DE PROTECTION DOSSIER
- SCHUTZHÜLLE FÜR RÜCKENLEHNE

FABLE LIFT

- ACCESSORI
- ACCESSORIES
- ACCESSOIRES
- ZUBEHÖR

COD. 107.1

- CUSCINO POGGIA TESTA CON FORO VISO IN MEMORY FOAM.
- MEMORY FOAM HEADREST PILLOW WITH FACE HOLE.
- REPOSE TÊTE EN MOUSSE MÉMOIRE AVEC TROU FACIAL.
- KOPFSTÜTZENKISSEN MIT PLATZ FÜR GESICHT AUS "MEMORY FOAM"

COD. SPECIAL

- SKAI SPECIAL
- SKAI SPECIAL
- SKAI SPECIAL
- SKAI SPECIAL

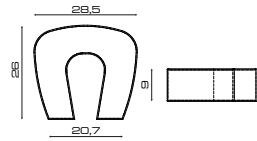

COD. 107.4

- CUSCINO SEMICILINDRICO POGGIA TESTA IN MEMORY-FOAM.
- MEMORY FOAM SEMI-CYLINDRICAL HEADREST PILLOW.
- REPOSE TÊTE SEMI-CYLINDRIQUE EN MOUSSE MÉMOIRE..
- HALBZILYNDRISCHES KISSEN FÜR DEN KOPF AUS "MEMORY FOAM"

COD. SPECIAL

- SKAI SPECIAL
- SKAI SPECIAL
- SKAI SPECIAL
- SKAI SPECIAL

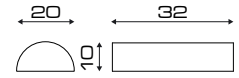

COD. 107.5

- CUSCINO A TRAPEZIO IN MEMORY FOAM.
- MEMORY FOAM TRAPEZOIDAL PILLOW.
- COUSSIN TRAPÉZOÏDALE EN MOUSSE MÉMOIRE.
- TRAPEZ- KISSEN AUS "MEMORY FOAM"

COD. SPECIAL

- SKAI SPECIAL
- SKAI SPECIAL
- SKAI SPECIAL
- SKAI SPECIAL

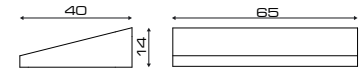

COD. 107.2

- CUSCINO CILINDRICO PER GINOCCHIA IN MEMORY FOAM.
- MEMORY FOAM CYLINDRICAL PILLOW RESTING KNEES.
- COUSSIN CYLINDRIQUE POUR LES GENOUX EN MOUSSE MÉMOIRE.
- ZILYNDERFÖRMIGES KISSEN FÜR DIE KNEE AUS "MEMORY FOAM"

COD. SPECIAL

- SKAI SPECIAL
- SKAI SPECIAL
- SKAI SPECIAL
- SKAI SPECIAL

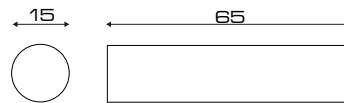

COD. 939

- CASCATA COMPLETA DI DIFFUSORE E DOCCETTA "PERFORMANCE" IN SILICONE NERO - **(ATTENZIONE: CON QUESTO PRODOTTO NON SONO UTILIZZABILI I TRAY 155 E 156).**
- WATERFALL COMPLETE WITH DIFFUSER AND BLACK SOLICONE "PERFORMANCE" HAND SHOWER. - **(ATTENTION: TRAYS 155 AND 156 CANNOT BE USED WITH THIS PRODUCT).**
- CASCADE COMPLÈTE AVEC DIFFUSEUR ET DOUCHETTE "PERFORMANCE" EN SILICONE NOIR.- **(ATTENTION : LES TRAYS 155 AND 156 NE PEUVENT PAS ÊTRE UTILISÉS AVEC CE PRODUIT)**
- WASSERFALL KOMPLETT MIT DIFFUSOR UND SCHWARZER SILIKONHANDBRAUSE "PERFORMANCE". - **VORSICHT: DIE TABLETS 155 UND 156 KÖNNEN NICHT MIT DIESEM PRODUKT VERWENDET WERDEN).**



COD. 107.3

- CUSCINO SEMICILINDRICO PER GINOCCHIA IN MEMORY-FOAM
- MEMORY FOAM SEMI-CYLINDRICAL PILLOW RESTING KNEES.
- COUSSIN SEMI-CYLINDR. POUR LES GENOUX EN MOUSSE MÉMOIRE
- HALBZILYNDRISCHES KISSEN FÜR DIE KNEE AUS "MEMORY FOAM"

COD. SPECIAL

- SKAI SPECIAL
- SKAI SPECIAL
- SKAI SPECIAL
- SKAI SPECIAL

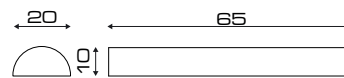

COD. 937

- ELIXIR - SHIRODHARA CON BASE GIREVOLE IN ALLUMINIO VERNICIATO NERA COMPLETO DI VASCA IN PLASTICA PER RECUPERO OLIO.
- ELIXIR - SHIRODHARA WITH SWIVEL BASE IN BLACK PAINTED ALUMINIUM WITH PLASTIC BOLS FOR OIL RECOVERY.
- ELIXIR - SHIRODHARA AVEC PIED PIVOTANT EN ALUMINIUM PEINT EN NOIR COMPLET DE BOL PLASTIQUE POUR LA RÉCOLTE DE L'HUILE.
- ELIXIR - SHIRODHARA MIT DREHBARER FUSS AUS SCHWARZ LACKIERTEM ALUMINIUM KOMPLETT MIT KUNSTSTOFFWANNE ZUR OLRUCKGEWINNUNG.





SKYLINE WASH



COD. 552M

- VERSIONI
- MODELS
- VERSIONS
- VERSIONEN



COD. 552M

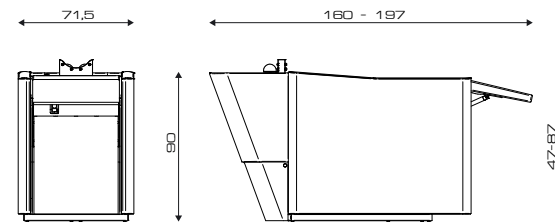

COD. 155

- TRAY-REGULAR CON CIOTOLE
- TRAY-REGULAR WITH BOWLS
- TRAY-REGULAR AVEC BOLS
- TRAY-REGULAR MIT 2 SCHÜSSELN



COD. 156

- TRAY-LARGE CON CIOTOLE
- TRAY-LARGE WITH BOWLS
- TRAY-LARGE AVEC BOLS
- TRAY-LARGE MIT 2 SCHÜSSELN



- ACCESSORI - ACCESSORIES - ACCESSOIRES - ZUBEHÖR



COD. 552P SKYLINE WASH RELAX

- MOVIMENTO ELETTRICO SINCRONIZZATO DELLO SCHIENALE, SEDILE E POGGIAGAMBE FINO A POSIZIONE SDRAIATA, VASCA IN CERAMICA BIANCA, MISCELATORE CON FORCELLA
- ELECTRICAL SYNCHRONIZED MOVEMENT OF BACKREST, SEAT AND FOOTREST UP TO LYING POSITION, WHITE CERAMIC BASIN, DROP-STOP WATER MIXER.
- MOUVEMENT ÉLECTRIQUE SYNCHRONISÉ DU DOSSIER, DE L'ASSISE ET DU REPOSE-PIEDS JUSQU'À LA POSITION ALLONGÉE, CUVETTE BLANCHE, MITIGEUR ANTI-GOUTTE.
- SYNCHRONISIERTE BEWEGUNG DER RÜCKENLEHNE, SITZUNG UND BEINSTÜTZE ZUR LIEGEPOSITION, WEISS BECKEN, MISCHBATTERIE MIT DROP-STOP SYSTEM.



COD. 552M SKYLINE WASH JET MASSAGE

- MOVIMENTO ELETTRICO SINCRONIZZATO. DELLO SCHIENALE, SEDILE E POGGIAGAMBE FINO A POSIZIONE SDRAIATA, MASSAGGIO JET, VASCA IN CERAMICA BIANCA, MISCELATORE CON FORCELLA.
- ELECTRICAL SYNCHRONIZED MOVEMENT OF BACKREST, SEAT AND FOOTREST UP TO LYING POSITION, JET MASSAGE, WHITE BASIN, DROP-STOP WATER MIXER.
- MOUVEMENT ÉLECTR. SYNCHRONISÉ DU DOSSIER, DE L'ASSISE ET DU REPOSE-PIEDS JUSQU'À LA POSITION ALLONGÉE, JET MASSAGE, CUVETTE BLANCHE, MITIGEUR ANTI-GOUTTE.
- SYNCHRONISIERTE BEWEGUNG DER RÜCKENLEHNE, SITZUNG UND BEINSTÜTZE ZUR LIEGEPOSITION, JET MASSAGE, WEISS BECKEN, MISCHBATTERIE MIT DROP-STOP SYSTEM.

COD. SPECIAL

- SKAI SPECIAL
- SKAI SPECIAL
- SKAI SPECIAL
- SKAI SPECIAL

COD. 155

- TRAY-REGULAR TAVOLOZZA TRATTAMENTI COMPLETA DI CIOTOLE
- TRAY-REGULAR, PALETTE FOR TREATMENTS COMPLETE WITH BOWLS
- TRAY-REGULAR, PLATEAU POUR SOINS COMPLET AVEC BOLS
- TRAY-REGULAR, PALETTE FÜR BEHANDLUNGEN MIT 2 SCHÜSSELN

COD. 156

- TRAY-LARGE TAVOLOZZA TRATTAMENTI COMPLETA DI CIOTOLE
- TRAY-LARGE, PALETTE FOR TREATMENTS COMPLETE WITH BOWLS
- TRAY-LARGE, PLATEAU POUR SOINS COMPLET AVEC BOLS
- TRAY-LARGE, PALETTE FÜR BEHANDLUNGEN MIT 2 SCHÜSSELN

COD. MASSAGE PLUS

- JET MASSAGE SU MATERASSO CON TELECOMANDO, DURATA MASSAGGIO 16/24 MIN.
- JET MASSAGE ON MATTRESS WITH REMOTE CONTROL, MASSAGE DURATION 16/24 MIN.
- JET MASSAGE SUR LE MATELAS AVEC TÉLÉCOMMANDE, DURÉE DU MASSAGE 16/24 MIN.
- GANZKÖRPER JET MASSAGE MIT FERNBEDIENUNG, MASSAGEDAUER 16/24 MIN.

COD. 470

- PEDALIERA PER VERSIONE RELAX.
- FOOT CONTROL FOR RELAX VERSION.
- COMMANDE AU PIED POUR VERSION RELAX.
- FUSSPEDAL FÜR MODELLE MIT RELAX.

COD. 472

- PEDALIERA PER VERSIONE JET MASSAGE.
- FOOT CONTROL FOR JET MASSAGE VERSION.
- COMMANDE AU PIED POUR VERSION JET MASSAGE.
- FUSSPEDAL FÜR MODELLE MIT JET MASSAGE.

SKYLINE WASH



COD. 552M
+ COD. 935



COD. 552M
+ COD. 936



COD. 552M



COD. 157



COD. SOUND WASH



COD. NER



COD. N&B



COD. TRA



COD. 935 RAIN



COD. 936 ELIXIR

- ACCESSORI
- ACCESSORIES
- ACCESSOIRES
- ZUBEHÖR

COD. THERMIC

- RISCALDAMENTO MATERASSO, CON PANNELLO DI CONTROLLO
- MATTRESS HEATING, WITH CONTROL BOARD
- MATELAS CHAUFFANT, AVEC PANNEAU DE CONTRÔLE
- BEHEIZTE MATRATZE MIT BEDIENFELD

COD. SOUND WASH

- SISTEMA INTEGRATO DI DIFFUSIONE SONORA
- INTEGRATED SOUND SYSTEM
- SYSTÈME DE DIFFUSION SONORE INTÉGRÉ
- INTEGRIERTE BESCHALLUNGSANLAGE

COD. NER COD. N&B COD. TRA

- SUPPLEMENTO CERAMICA NERA O INTERNO BIANCO-ESTERNO NERO OPACO O INTERNO BIANCO-ESTERNO TRAVERTINO.
- EXTRA CHARGE FOR BLACK BASIN OR INTERIOR WHITE-EXTERIOR MATT BLACK OR INTERIOR WHITE-EXTERIOR TRAVERTINE.
- SUPPLÉMENT CUVETTE NOIRE OU INTÉRIEUR BLANC-EXTÉRIEUR NOIR MAT OU INTÉRIEUR BLANC-EXTÉRIEUR TRAVERTIN.
- AUFPREIS FÜR SCHWARZES WASCHBECKEN ODER INNEN WEISS, AUSSEN MATTSCHWARZ ODER INNEN WEISS, AUSSEN TRAVERTIN.

COD. 157

- SCIVOLO LAVATESTA IN PLASTICA NERA
- BLACK PLASTIC GROVE
- CUVETTE EN PLASTIQUE NOIR
- BECKEN AUS SCHWARZ KUNSTSTOFF

COD. 935

- RAIN - GRUPPO DOCCIA CASCATA
- RAIN - WATERFALL SHOWER KIT
- RAIN - KIT DE DOUCHE CASCADE
- RAIN - WASSERFALL DUSCHSET

COD. 936

- KIT SHIRODHARA, INTERNO VASCA, COMPLETO DI VASCA IN PLASTICA PER RECUPERO OLIO
- KIT SHIRODHARA, INSIDE BASIN, WITH PLASTIC BOLS FOR OIL RECOVERY.
- KIT SHIRODHARA, INTERIEUR CUVETTE, COMPLÈT DE BOL PLASTIQUE POUR LA RÉCOLTE DE L'HUILE.
- KIT SHIRODHARA, IM WASCHBECKEN, KOMPLETT MIT KUNSTSTOFFWANNE ZUR OLRÜCKGEWINNUNG

COD. 465

- SUPPLEMENTO MISCELATORE TERMOSTATICO CON FORCELLA.
- EXTRA CHARGE FOR THERMOSTATIC WATER MIXER WITH DRIP-PROOF SHOWER.
- SUPPLÉMENT MITIGEUR THERMOSTATIQUE AVEC SYSTÈME ANTI-ÉGOUTTEMENT.
- AUFPREIS MISCHBATTERIE MIT THERMOSTAT UND ANTI-TROPFEN SYSTEM.

COD. M0/553

- FODERINA PVC PROTEZIONE ALZAGAMBE
- PVC LEGREST PROTECTION
- HOUSSE DE PROTECTION EN PVC POUR REPOSE-PIEDS
- SCHUTZ DER BEINSTÜTZEN AUS PVC

COD. M0/552

- FODERINA PVC SCHIENALE
- PLASTIC PVC BACKREST COVER
- HOUSSE PROTECTION DOSSIER EN PVC
- SCHUTZHÜLLE PVC FÜR RÜCKENLEHNE

SKYLINE WASH

- ACCESSORI
- ACCESSORIES
- ACCESSOIRES
- ZUBEHÖR

COD. 107.1

- CUSCINO POGGIA TESTA CON FORO VISO IN MEMORY FOAM.
- MEMORY FOAM HEADREST PILLOW WITH FACE HOLE.
- REPOSE TÊTE EN MOUSSE MÉMOIRE AVEC TROU FACIAL.
- KOPFSTÜTZENKISSEN MIT PLATZ FÜR GESICHT AUS "MEMORY FOAM"

COD. SPECIAL

- SKAI SPECIAL
- SKAI SPECIAL
- SKAI SPECIAL
- SKAI SPECIAL

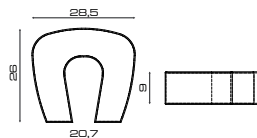

COD. 107.4

- CUSCINO SEMICILINDRICO POGGIA TESTA IN MEMORY-FOAM.
- MEMORY FOAM SEMI-CYLINDRICAL HEADREST PILLOW.
- REPOSE TÊTE SEMI-CYLINDRIQUE EN MOUSSE MÉMOIRE..
- HALBZILYNDRISCHES KISSEN FÜR DEN KOPF AUS "MEMORY FOAM"

COD. SPECIAL

- SKAI SPECIAL
- SKAI SPECIAL
- SKAI SPECIAL
- SKAI SPECIAL

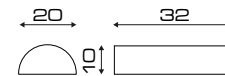

COD. 107.5

- CUSCINO A TRAPEZIO IN MEMORY FOAM.
- MEMORY FOAM TRAPEZOIDAL PILLOW.
- COUSSIN TRAPÉZOÏDALE EN MOUSSE MÉMOIRE.
- TRAPEZ- KISSEN AUS "MEMORY FOAM"

COD. SPECIAL

- SKAI SPECIAL
- SKAI SPECIAL
- SKAI SPECIAL
- SKAI SPECIAL

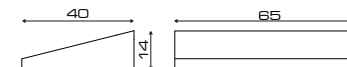

COD. 107.2

- CUSCINO CILINDRICO PER GINOCCHIA IN MEMORY FOAM.
- MEMORY FOAM CYLINDRICAL PILLOW RESTING KNEES.
- COUSSIN CYLINDRIQUE POUR LES GENOUX EN MOUSSE MÉMOIRE.
- ZILYNDERFÖRMIGES KISSEN FÜR DIE KNEE AUS "MEMORY FOAM"

COD. SPECIAL

- SKAI SPECIAL
- SKAI SPECIAL
- SKAI SPECIAL
- SKAI SPECIAL

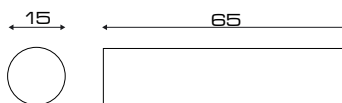

COD. 939

- CASCATA COMPLETA DI DIFFUSORE E DOCCETTA "PERFORMANCE" IN SILICONE NERO - (ATTENZIONE: CON QUESTO PRODOTTO NON SONO UTILIZZABILI I TRAY 155 E 156).
- WATERFALL COMPLETE WITH DIFFUSER AND BLACK SOLICONE "PERFORMANCE" HAND SHOWER. - (ATTENTION: TRAYS 155 AND 156 CANNOT BE USED WITH THIS PRODUCT).
- CASCADE COMPLÈTE AVEC DIFFUSEUR ET DOUCHETTE "PERFORMANCE" EN SILICONE NOIR.- (ATTENTION : LES TRAYS 155 AND 156 NE PEUVENT PAS ÊTRE UTILISÉS AVEC CE PRODUIT)
- WASSERFALL KOMPLETT MIT DIFFUSOR UND SCHWARZER SILIKONHANDBRAUSE "PERFORMANCE". - VORSICHT: DIE TABLETS 155 UND 156 KÖNNEN NICHT MIT DIESEM PRODUKT VERWENDET WERDEN).



COD. 107.3

- CUSCINO SEMICILINDRICO PER GINOCCHIA IN MEMORY-FOAM
- MEMORY FOAM SEMI-CYLINDRICAL PILLOW RESTING KNEES.
- COUSSIN SEMI-CYLINDR. POUR LES GENOUX EN MOUSSE MÉMOIRE
- HALBZILYNDRISCHES KISSEN FÜR DIE KNEE AUS "MEMORY FOAM"

COD. SPECIAL

- SKAI SPECIAL
- SKAI SPECIAL
- SKAI SPECIAL
- SKAI SPECIAL

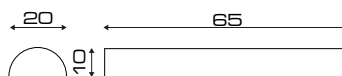

COD. 937

- ELIXIR - SHIRODHARA CON BASE GIREVOLE IN ALLUMINIO VERNICIATO NERA COMPLETO DI VASCA IN PLASTICA PER RECUPERO OLIO.
- ELIXIR - SHIRODHARA WITH SWIVEL BASE IN BLACK PAINTED ALUMINIUM WITH PLASTIC BOLS FOR OIL RECOVERY.
- ELIXIR - SHIRODHARA AVEC PIED PIVOTANT EN ALUMINIUM PEINT EN NOIR COMPLET DE BOL PLASTIQUE POUR LA RÉCOLTE DE L'HUILE.
- ELIXIR - SHIRODHARA MIT DREHBARER FUSS AUS SCHWARZ LACKIERTEM ALUMINIUM KOMPLETT MIT KUNSTSTOFFWANNE ZUR OLRUCKGEWINNUNG.





ELYSIUM NEWS

Carsat

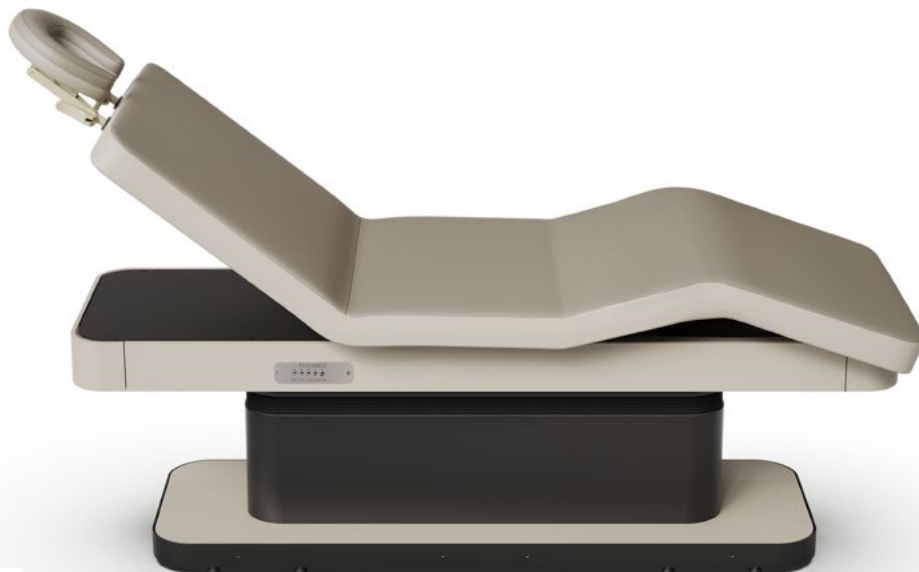

UP/DOWN

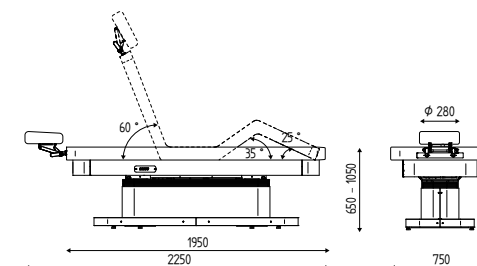

COD. 555 + VISO + MOT + LEG + THERMIC + MASSAGE

- VERSIONI
- MODELS
- VERSIONS
- VERSIONEN

COD. 555

- LETTINO PER TRATTAMENTI, MOVIMENTO VERTICALE MOTORIZZATO DELLA STRUTTURA CON PEDALIERA "UP/DOWN".
- TREATMENT BED, MOTORISED VERTICAL MOVEMENT OF THE STRUCTURE WITH "UP/DOWN" FOOT CONTROL.
- TABLE SOINS, MOUVEMENT VERTICAL MOTORISÉ DE LA STRUCTURE AVEC COMMANDE AU PIE "UP/DOWN".
- WELLNESSLIEGE, VERTIKALE MOTORISIERTE BEWEGUNG VON DER STRUKTUR MIT FUSSPEDAL "UP/DOWN".

COD.

MASSAGE

- JET MASSAGE SU MATERASSO, DURATA MASSAGGIO 8/16 MIN.
- JET MASSAGE ON MATTRESS, MASSAGE DURATION 8/16 MIN.
- JET MASSAGE SUR LE MATELAS, DURÉE DU MASSAGE 8/16 MIN.
- GANZKÖRPER JET MASSAGE, MASSAGEDAUER 8/16 MIN.

COD.

MASSAGE PLUS

- JET MASSAGE SU MATERASSO, DURATA MASSAGGIO 16/24 MIN.
- JET MASSAGE ON MATTRESS, MASSAGE DURATION 16/24 MIN.
- JET MASSAGE SUR LE MATELAS, DURÉE DU MASSAGE 16/24 MIN.
- GANZKÖRPER JET MASSAGE, MASSAGEDAUER 16/24 MIN.

COD.

THERMIC

- RISCALDAMENTO MATERASSO, CON PANNELLO DI CONTROLLO
- MATTRESS HEATING, WITH CONTROL BOARD
- MATELAS CHAUFFANT, AVEC PANNEAU DE CONTRÔLE
- BEHEIZTE MATRATZE MIT BEDIENFELD

ELYSIUM NEWS

Carsat



COD. 555 + THERMIC + MASSAGE



**COD. 555
COD. VISO
COD. MOT
COD. LEG
COD. THERMIC
COD. MASSAGE**



COD. 555 + VISO + MOT + LEG + THERMIC + MASSAGE

- ACCESSORI
- ACCESSORIES
- ACCESSOIRES
- ZUBEHÖR

- COD. MOT**
- SCHIENALE CON ATTUATORE ELETTRICO
 - BACKREST WITH ELECTRIC MOTOR
 - DOSSIER RÉGLABLE AVEC MOTEUR ÉLECTRIQUE
 - RÜCKENLEHNE MIT ELEKTRISCHE EINSTELLUNG

- COD. LEG**
- ALZAGAMBE CON ATTUATORE ELETTRICO
 - LEGREST WITH ELECTRIC MOTOR
 - REPOSE JAMBES RÉGLABLE AVEC MOTEUR ÉLECTRIQUE
 - BEINSTÜTZE MIT ELEKTRISCHE EINSTELLUNG

- COD. SOUND**
- SISTEMA INTEGRATO DI DIFFUSIONE SONORA
 - INTEGRATED SOUND SYSTEM
 - SYSTÈME DE DIFFUSION SONORE INTÉGRÉ
 - INTEGRIERTE BESCHALLUNGSANLAGE

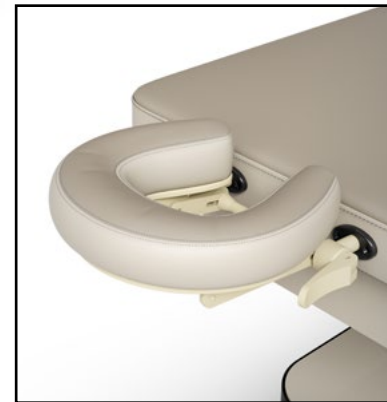

COD. VISO

- COD. VISO**
- CUSCINO PER IL VISO CON SNODO
 - FACE PILLOW WITH ARTICULATING JOINT
 - COUSSIN POUR LE VISAGE AVEC ARTICULATION
 - GESICHTSKISSEN MIT GELENK

- COD. SPECIAL**
- SKAI SPECIAL
 - SKAI SPECIAL
 - SKAI SPECIAL
 - SKAI SPECIAL

- COD. 9023**
- PORTAROTOLO PER LETTO.
 - PAPER-ROLL HOLDER FOR BED
 - PORTE ROULEAU POUR TABLE
 - HALTER FÜR PAPIERROLLE

ELYSIUM

Carsat

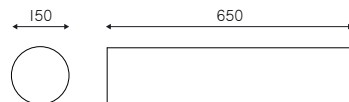

- COD. 107.2**
- ◆ CUSCINO CILINDRICO PER GINOCCHIA IN MEMORY FOAM
 - ◆ MEMORY FOAM CYLINDRIC PILLOW RESTING KNEES.
 - ◆ COUSSIN CYLINDRIQUE POUR LES GENOUX EN MOUSSE MÉMOIRE.
 - ◆ ZILYNDERFÖRMIGES KISSEN FÜR DIE KNIE AUS "MEMORY FOAM"

- COD. SPECIAL**
- ◆ SKAI SPECIAL
 - ◆ SKAI SPÉCIAL
 - ◆ SKAI SPÉCIAL
 - ◆ SKAI SPECIAL

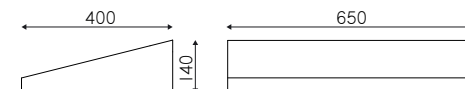

- COD. 107.5**
- ◆ CUSCINO A TRAPEZIO IN MEMORY FOAM.
 - ◆ MEMORY FOAM TRAPEZOIDAL PILLOW
 - ◆ COUSSIN TRAPEZOÏDALE EN MOUSSE MÉMOIRE.
 - ◆ TRAPEZ- KISSEN AUS "MEMORY FOAM"

- COD. SPECIAL**
- ◆ SKAI SPECIAL
 - ◆ SKAI SPÉCIAL
 - ◆ SKAI SPÉCIAL
 - ◆ SKAI SPECIAL



- COD. 107.3**
- ◆ CUSCINO SEMICILINDRICO PER GINOCCHIA IN MEMORY-FOAM.
 - ◆ MEMORY FOAM SEMI-CYLINDRICAL PILLOW RESTING KNEES.
 - ◆ COUSSIN SEMI-CYLINDRIQUE POUR LES GENOUX EN MOUSSE MÉMOIRE
 - ◆ HALBZILYNDRISCHES KISSEN FÜR DIE KNIE AUS "MEMORY FOAM"

- COD. SPECIAL**
- ◆ SKAI SPECIAL
 - ◆ SKAI SPÉCIAL
 - ◆ SKAI SPÉCIAL
 - ◆ SKAI SPECIAL

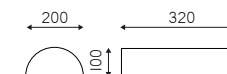

- COD. 107.4**
- ◆ CUSCINO SEMICILINDRICO POGGIA TESTA IN MEMORY-FOAM.
 - ◆ MEMORY FOAM SEMI-CYLINDRICAL HEADREST PILLOW.
 - ◆ REPOSE TÊTE SEMI-CYLINDRIQUE EN MOUSSE MÉMOIRE..
 - ◆ HALBZILYNDRISCHES KISSEN FÜR DEN KOPF AUS "MEMORY FOAM"

- COD. SPECIAL**
- ◆ SKAI SPECIAL
 - ◆ SKAI SPÉCIAL
 - ◆ SKAI SPÉCIAL
 - ◆ SKAI SPECIAL



LAVAGGI BACKWASH UNITS BACS DE LAVAGE WASCHANLAGEN

IT I LAVATESTA PIETRANERA SONO PENSATI E CONCEPITI PER RIDEFINIRE L'AREA DEL LAVAGGIO DEI CAPELLI. I NOSTRI MODELLI OFFRONO SOLUZIONI IDEALI PER TUTTE LE ESIGENZE OPERATIVE E DI STILE. SONO COSTRUITI CON I MIGLIORI MATERIALI PER RESISTERE NEL TEMPO E PER OFFRIRE UN'ESPERIENZA DI LAVAGGIO DI ALTO LIVELLO, CHE CLIENTI E PARRUCCHIERI MERITANO. ANCHE L'ASPETTO DELLA FACILITÀ D'INSTALLAZIONE E MANUTENZIONE È PARTICOLARMENTE CURATO. I LAVATESTA PER PARRUCCHIERI DI ULTIMA GENERAZIONE POI, TRASFORMANO IL SALONE DI ACCONCIATURA IN UN CENTRO BENESSERE, RENDENDO POSSIBILE OFFRIRE I SERVIZI HEAD SPA SEMPRE PIÙ RICHIESTI. PER FAR VIVERE AI VOSTRI CLIENTI UN'ESPERIENZA UNICA.

EN PIETRANERA BACKWASH UNITS ARE DESIGNED AND CONCEIVED TO REDEFINE THE HAIR WASHING AREA. OUR MODELS OFFER IDEAL SOLUTIONS FOR ALL OPERATIONAL AND STYLE REQUIREMENTS. THEY ARE MANUFACTURED WITH THE BEST MATERIALS TO LAST OVER TIME AND TO OFFER A TOP WASHING EXPERIENCE THAT CLIENTS AND HAIRDRESSERS DESERVE. EASE OF INSTALLATION AND MAINTENANCE IS ALSO PARTICULARLY TAKEN CARE OF. THE LATEST GENERATION BACKWASH UNITS THEN TRANSFORM THE HAIR SALON INTO A WELLNESS CENTRE, MAKING IT POSSIBLE TO OFFER THE HEAD SPA SERVICES THAT ARE INCREASINGLY IN DEMAND. TO GIVE YOUR CUSTOMERS A UNIQUE EXPERIENCE.

FR LES BACS DE LAVAGE PIETRANERA SONT CONÇUS POUR REDÉFINIR L'ESPACE DE LAVAGE DES CHEVEUX. NOS MODÈLES PROPOSENT DES SOLUTIONS IDÉALES POUR TOUTES LES EXIGENCES OPÉRATIONNELLES ET POUR TOUS LES STYLES. ILS SONT FABRIQUÉS AVEC LES MEILLEURS MATÉRIAUX POUR RÉSUMER DANS LE TEMPS ET OFFRIR UNE EXPÉRIENCE DE LAVAGE DES CHEVEUX DE HAUT NIVEAU, QUE LES CLIENTS ET LES COIFFEURS MÉRITENT. LES FACILITÉS D'INSTALLATION ET D'ENTRETIEN SONT ÉGALEMENT DES ASPECTS TRÈS SOIGNÉS. LES BACS DE LAVAGE DERNIER CRI TRANSFORMENT AUSSI LE SALON DE COIFFURE EN CENTRE DE BIEN-ÊTRE, CE QUI PERMET DE PROPOSER DES SERVICES BIEN-ÊTRE POUR LE CUIR CHEVELU, DE PLUS EN PLUS DEMANDÉS. POUR FAIRE VIVRE À VOS CLIENTS UNE EXPÉRIENCE UNIQUE.

DE PIETRANERA-HAARWASCHANLAGEN WURDEN ENTWICKELT UND KONZIPIERT, UM DEN ARBEITSBEREICH NEU ZU DEFINIEREN. UNSERE MODELLE BIETEN IDEALE LÖSUNGEN FÜR ALLE BETRIEBLICHEN UND STILISTISCHEN ANFORDERUNGEN. SIE WERDEN AUS DEN BESTEN MATERIALIEN HERGESTELLT, UM ÜBER LANGE ZEIT ZU HALTEN UND EIN WASCHERLEBENS AUF HOHEM NIVEAU ZU BIETEN, DAS KUNDEN UND FRISEURE BRAUCHEN. AUF INSTALLATIONS- UND WARTUNGSFREUNDLICHKEIT WIRD EBENFALLS BESONDERER WERT GELEGT. HAARWASCHANLAGEN DER NEUESTEN GENERATION VERWANDELN DEN FRISEURSAALON IN EIN WELLNESS-ZENTRUM, MIT HEAD SPA-DIENSTLEISTUNGEN, DIE AUF IMMER GRÖßEREN ANKLANG STOSSEN. DAMIT SIE IHREN KUNDEN EIN EINZIGARTIGES ERLEBNIS BIETEN.





NUBI WASH

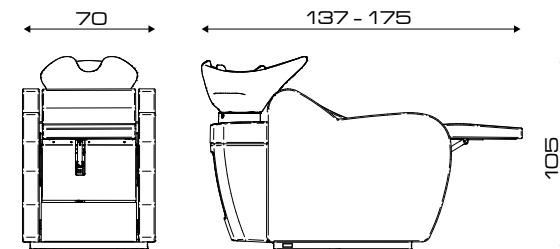

- VERSIONI
- MODELS
- VERSIONS
- VERSIONEN

- ACCESSORI
- ACCESSORIES
- ACCESSOIRES
- ZUBEHÖR



NUBI RELAX

- MOVIMENTO ELETTRICO SINCRONIZZATO DELLO SCHIENALE, SEDILE E POGGIAGAMBE FINO A POSIZIONE SDRAIATA, VASCA N1 BIANCA, MISCELATORE CON FORCELLA, CARTER ABS BIANCO.
- ELECTRICAL SYNCHRONIZED MOVEMENT OF BACKREST, SEAT AND FOOTREST UP TO LYING POSITION, WHITE BASIN N1, DROP-STOP SYSTEM, BACK COVER WHITE ABS.
- MOUVEMENT ÉLECTRIQUE SYNCHRONISÉ DU DOSSIER, DE L'ASSISE ET DU REPOSE-PIEDS JUSQU'À LA POSITION ALLONGÉE, CUVETTE BLANCHE N1, MITIGEUR ANTI-GOUTTE, CACHE ABS BLANCHE.
- SYNCHRONISIERTE BEWEGUNG DER RÜCKENLEHNE, SITZUNG UND BEINSTÜTZE ZUR LIEGEPOSITION, WEISS BECKEN N1, MISCHBATTERIE MIT DROP-STOP SYSTEM, WEISSE RÜCKGEHÄUSE.

COD. 554P



NUBI JET MASSAGE

- MOVIMENTO ELETTRICO SINCRONIZZATO. DELLO SCHIENALE, SEDILE E POGGIAGAMBE FINO A POSIZIONE SDRAIATA, MASSAGGIO JET, VASCA N1 BIANCA, MISCELATORE CON FORCELLA, CARTER ABS BIANCO.
- ELECTRICAL SYNCHRONIZED MOVEMENT OF BACKREST, SEAT AND FOOTREST UP TO LYING POSITION, JET MASSAGE, WHITE BASIN N1, DROP-STOP SYSTEM, BACK COVER WHITE ABS.
- MOUVEMENT ÉLECTR. SYNCHRONISÉ DU DOSSIER, DE L'ASSISE ET DU REPOSE-PIEDS JUSQU'À LA POSITION ALLONGÉE, JET MASSAGE, CUVETTE BLANCHE N1, MITIGEUR ANTI-GOUTTE, CACHE ABS BLANCHE.
- SYNCHRONISIERTE BEWEGUNG DER RÜCKENLEHNE, SITZUNG UND BEINSTÜTZE ZUR LIEGEPOSITION, JET MASSAGE, WEISS BECKEN N1, MISCHBATTERIE MIT DROP-STOP SYSTEM, WEISSE RÜCKGEHÄUSE..

COD. 554M

- COD. N3** •SUPPLEMENTO LAVABO NERO N3
- EXTRA CHARGE BLACK N3 BASIN.
- SUPPLÉMENT CUVETTE N3 EN NOIR
- AUFPREIS SCHWARZ BECKEN N3

COD. SPECIAL

- SKAI SPECIAL
- SKAI SPÉCIAL
- SKAI SPÉCIAL
- SKAI SPECIAL

COD. M0/554

- FODERINA SCHIENALE
- PLASTIC BACKREST COVER
- HOUSSE PROTECTION DOSSIER
- SCHUTZHÜLLE FÜR RÜCKENLEHNE

COD. THERMIC

- RISCALDAMENTO MATERASSO.
- MATRESS HEATING.
- MATELAS CHAUFFANT.
- BEHEIZTE MATRATZE.

LONDRA FIRST



COD. 548P



COD. 548P+ OPTIMA

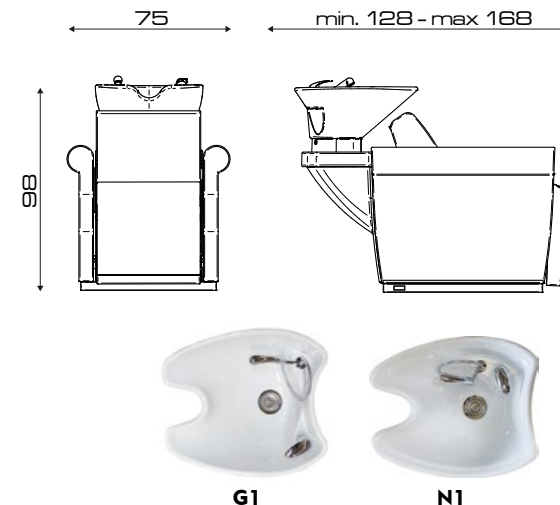

- VERSIONI
- MODELS
- VERSIONS
- VERSIONEN

- ACCESSORI
- ACCESSORIES
- ACCESSOIRES
- ZUBEHÖR



LONDRA FIRST RELAX

- MOVIMENTO ELETTRICO SINCRONIZZATO DELLO SCHIENALE, SEDILE E POGGIAGAMBE, VASCA N1 BIANCA, MISCELATORE CON FORCELLA, CARTER ABS BIANCO.
- ELECTRICAL SYNCHRONIZED MOVEMENT OF BACKREST, SEAT AND FOOTREST, WHITE BASIN N1, DROP-STOP SYSTEM, BACK COVER WHITE ABS.
- MOUVEMENT ÉLECTRIQUE SYNCHRONISÉ DU DOSSIER, DE L'ASSISE ET DU REPOSE-PIEDS, CUVETTE BLANCHE N1, MITIGEUR ANTI-GOUTTE, CACHE ABS BLANCHE.
- SYNCHRONISIERTE BEWEGUNG DER RÜCKENLEHNE, SITZUNG UND BEINSTÜTZE, WEISS BECKEN N1, MISCHBATTERIE MIT DROP-STOP SYSTEM, WEISSE RÜCKGEHÄUSE

COD. 548P



LONDRA FIRST JET MASSAGE

- MOVIMENTO ELETTRICO SINCRONIZ. DELLO SCHIENALE, SEDILE E POGGIAGAMBE, MASSAGGIO JET, VASCA N1 BIANCA, MISCELATORE CON FORCELLA, CARTER ABS BIANCO.
- ELECTRICAL SYNCHRONIZED MOVEMENT OF BACKREST, SEAT AND FOOTREST, JET MASSAGE, WHITE BASIN N1, DROP-STOP SYSTEM, BACK COVER WHITE ABS.
- MOUVEMENT ÉLECTR. SYNCHRONISÉ DU DOSSIER, DE L'ASSISE ET DU REPOSE-PIEDS, JET MASSAGE, CUVETTE BLANCHE N1, MITIGEUR ANTI-GOUTTE, CACHE ABS BLANCHE.
- SYNCHRONISIERTE BEWEGUNG DER RÜCKENLEHNE, SITZUNG UND BEINSTÜTZE, JET MASSAGE, WEISS BECKEN N1, MISCHBATTERIE MIT DROP-STOP SYSTEM, WEISSE RÜCKGEHÄUSE.

COD. 548M

COD. G1

- VASCA G1 - NESSUN SUPPLEMENTO PREZZO
- BASIN G1 - NO EXTRA PRICE
- CUVETTE G1 - PAS DE SUPPLÉMENT DE PRIX
- WASCHBECKEN G1 - OHNE ZUSATZKOSTEN

COD. G3-N3

- SUPPLEMENTO LAVABO NERO G3-N3
- EXTRA CHARGE FOR BLACK G3-N3 BASIN.
- SUPPLÉMENT CUVETTE G3-N3 EN NOIR
- AUFPREIS SCHWARZ BECKEN G3-N3

COD. SPECIAL

- SKAI SPECIAL
- SKAI SPÉCIAL
- SKAI SPÉCIAL
- SKAI SPECIAL

COD. OPTIMA

- VERSIONE OPTIMA BRACC. CON BORDINO E BOTTONI
- OPTIMA VERSION WITH PIPING IN THE ARMRESTS AND BOTTONS
- "OPTIMA" ACCOUDOIRS AVEC PIPING ET BOUTONS
- OPTIMA VERSION, ARMLEHNEN MIT PIPING UND KNÖPFEN

COD. M0/400

- FODERINA SCHIENALE
- PLASTIC BACKREST COVER
- HOUSSE PROTECTION DOSSIER
- SCHUTZHÜLLE FÜR RÜCKENLEHNE

CAMACHO FIRST



INSTALLAZIONE / INSTALLATION
INSTALLATION / INSTALLATION

TAPPEZZERIA / UPHOLSTERY
TAPISSERIE / POLSTER

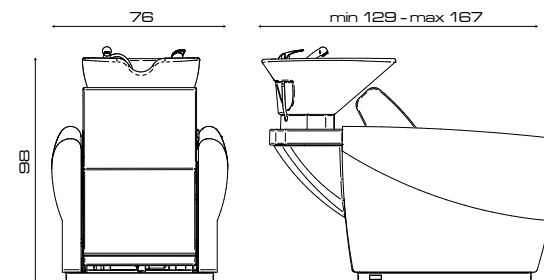

G1



N1

- VERSIONI
- MODELS
- VERSIONS
- VERSIONEN

- ACCESSORI
- ACCESSORIES
- ACCESSOIRES
- ZUBEHÖR



CAMACHO FIRST RELAX

COD. 538P

- MOVIMENTO ELETTRICO SINCRONIZZATO DELLO SCHIENALE, SEDILE E POGGIAGAMBE, VASCA N1 BIANCA, MISCELATORE CON FORCELLA, CARTER ABS BIANCO.
- ELECTRICAL SYNCHRONIZED MOVEMENT OF BACKREST, SEAT AND FOOTREST, WHITE BASIN N1, DROP-STOP SYSTEM, BACK COVER WHITE ABS.
- MOUVEMENT ÉLECTRIQUE SYNCHRONISÉ DU DOSSIER, DE L'ASSISE ET DU REPOSE-PIEDS, CUVETTE BLANCHE N1, MITIGEUR ANTI-GOUTTE, CACHE ABS BLANCHE.
- SYNCHRONISIERTA BEWEGUNG DER RÜCKENLEHNE, SITZUNG UND BEINSTÜTZE, WEISS BECKEN N1, MISCHBATTERIE MIT DROP-STOP SYSTEM, WEISSE RÜCKGEHÄUSE



CAMACHO FIRST JET MASSAGE

COD. 538M

- MOVIMENTO ELETTRICO SINCRONIZ. DELLO SCHIENALE, SEDILE E POGGIAGAMBE, MASSAGGIO JET, VASCA N1 BIANCA, MISCELATORE CON FORCELLA, CARTER ABS BIANCO.
- ELECTRICAL SYNCHRONIZED MOVEMENT OF BACKREST, SEAT AND FOOTREST, JET MASSAGE, WHITE BASIN N1, DROP-STOP SYSTEM, BACK COVER WHITE ABS.
- MOUVEMENT ÉLECTR. SYNCHRONISÉ DU DOSSIER, DE L'ASSISE ET DU REPOSE-PIEDS, JET MASSAGE, CUVETTE BLANCHE N1, MITIGEUR ANTI-GOUTTE, CACHE ABS BLANCHE.
- SYNCHRONISIERTA BEWEGUNG DER RÜCKENLEHNE, SITZUNG UND BEINSTÜTZE, JET MASSAGE, WEISS BECKEN N1, MISCHBATTERIE MIT DROP-STOP SYSTEM, WEISSE RÜCKGEHÄUSE.

- COD. G1**
- VASCA G1 - NESSUN SUPPLEMENTO PREZZO
 - BASIN G1 - NO EXTRA PRICE
 - CUVETTE G1 - PAS DE SUPPLÉMENT DE PRIX
 - WASCHBECKEN G1 - OHNE ZUSATZKOSTEN

- COD. G3-N3**
- SUPPLEMENTO LAVABO NERO G3-N3
 - EXTRA CHARGE BLACK G3-N3 BASIN.
 - SUPPLÉMENT CUVETTE G3-N3 EN NOIR
 - AUFPREIS SCHWARZ BECKEN G3-N3

- COD. SPECIAL**
- SKAI SPECIAL
 - SKAI SPECIAL
 - SKAI SPÉCIAL
 - SKAI SPECIAL

- COD. M0/400**
- FODERINA SCHIENALE
 - PLASTIC BACKREST COVER
 - HOUSSE PROTECTION DOSSIER
 - SCHUTZHÜLLE FÜR RÜCKENLEHNE

WEN FIRST



INSTALLAZIONE / INSTALLATION
INSTALLATION / INSTALLATION

TAPPEZZERIA / UPHOLSTERY
TAPISSERIE / POLSTER

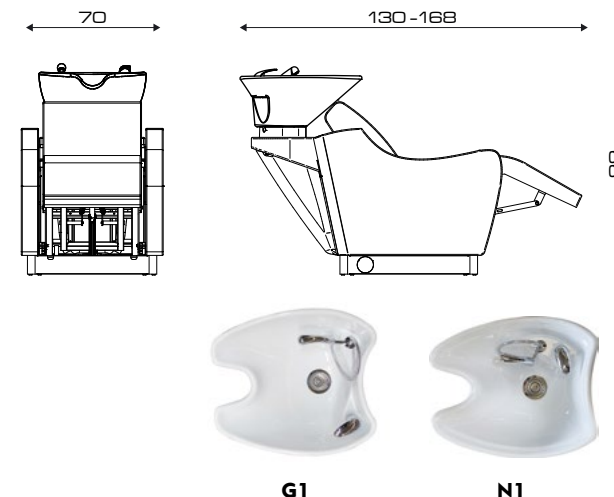

- VERSIONI
- MODELS
- VERSIONS
- VERSIONEN

- ACCESSORI
- ACCESSORIES
- ACCESSOIRES
- ZUBEHÖR



WEN FIRST RELAX

- MOVIMENTO ELETTRICO SINCRONIZZATO DELLO SCHIENALE, SEDILE E POGGIAGAMBE, VASCA N1 BIANCA, MISCEL. CON FORCELLA, CARTER ABS BIANCO.
- ELECTRICAL SYNCHRONIZED MOVEMENT OF BACKREST, SEAT AND FOOTREST, WHITE BASIN N1, DROP-STOP SYSTEM, BACK COVER WHITE ABS.
- MOUVEMENT ÉLECTRIQUE SYNCHRONISÉ DU DOSSIER, DE L'ASSISE ET DU REPOSE-PIEDS, CUVETTE BLANCHE N1, MITIGEUR ANTI-GOUTTE, CACHE ABS BLANCHE.
- SYNCHRONISIERTE BEWEGUNG DER RÜCKENLEHNE, SITZUNG UND BEINSTÜTZE, WEISS BECKEN N1, MISCHBATTERIE MIT "DROP-STOP"SYSTEM, WEISSE RÜCKGEHÄUSE

COD. 546P



WEN FIRST JET MASSAGE

- MOVIMENTO ELETTR. SINCRONIZ. DELLO SCHIENALE, SEDILE E POGGIAGAMBE, MASSAGGIO JET, VASCA N1 BIANCA, MISCEL. CON FORCELLA, CARTER ABS BIANCO.
- ELECTRICAL SYNCHRONIZED MOVEMENT OF BACKREST, SEAT AND FOOTREST, JET MASSAGE, WHITE BASIN N1, DROP-STOP SYSTEM, BACK COVER WHITE ABS.
- MOUVEMENT ÉLECTR. SYNCHRONISÉ DU DOSSIER, DE L'ASSISE ET DU REPOSE-PIEDS, JET MASSAGE, CUVETTE BLANCHE N1, MITIGEUR ANTI-GOUTTE, CACHE ABS BLANCHE.
- SYNCHRONISIERTE BEWEGUNG DER RÜCKENLEHNE, SITZUNG UND BEINSTÜTZE, JET MASSAGE, WEISS BECKEN N1, MISCHBATTERIE MIT "DROP-STOP"SYSTEM, WEISSE RÜCKGEHÄUSE.

COD. 546M

COD. SPECIAL

- SKAI SPECIAL
- SKAI SPÉCIAL
- SKAI SPÉCIAL
- SKAI SPECIAL

COD. M0/400

- FODERINA SCHIENALE
- PLASTIC BACKREST COVER
- HOUSSE PROTECTION DOSSIER
- SCHUTZHÜLLE RÜCKENLEHNE

COD. 144

- PORTA DOSATORE
- SHAMPOO HOLDER
- PORTE-SHAMPOOING
- FLASCHEHALTER

COD. N1

- VASCA N1 - NESSUN SUPPLEMENTO PREZZO
- BASIN N1 - NO EXTRA PRICE
- CUVETTE N1 - PAS DE SUPPLÉMENT DE PRIX
- WASCHBECKEN N1 - OHNE ZUSATZKOSTEN

COD. G3-N3

- SUPPL. LAVABO NERO G3-N3.
- EXTRA CHARGE BLACK G3-N3 BASIN.
- SUPPLÉM. CUVETTE G3-N3 EN NOIR
- AUFPREIS SCHWARZ BECKEN G3-N3

COD. OPTIMA

- VERSIONE OPTIMA BRACCIOLI CON BORDINO.
- OPTIMA FINISHING (ARMRESTS WITH PIPING).
- SUPPLÉM. "OPTIMA" ACCOUD. AVEC GALON.
- "OPTIMA" VERSION, ARMLEHNEN MIT KUNSTOFFLEDER

TRESOR FIRST

INSTALLAZIONE / INSTALLATION
INSTALLATION / INSTALLATION
COD.510P/510M

TAPPEZZERIA / UPHOLSTERY
TAPISSERIE / POLSTER

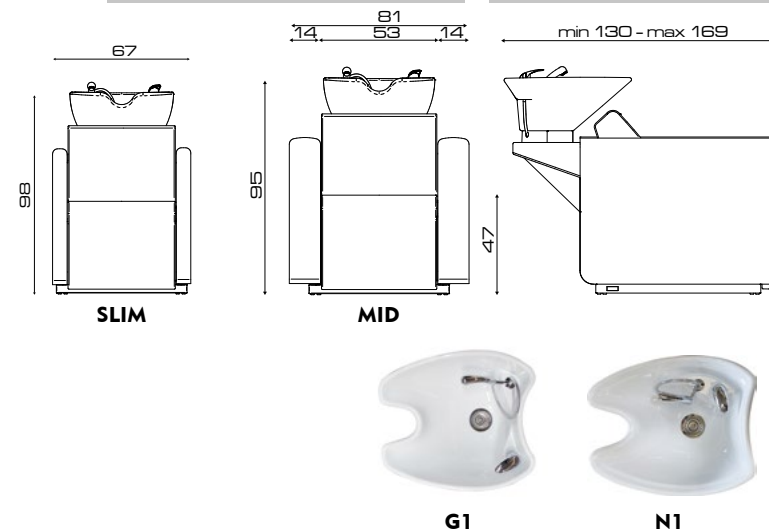

- VERSIONI
- MODELS
- VERSIONS
- VERSIONEN

- ACCESSORI
- ACCESSORIES
- ACCESSOIRES
- ZUBEHÖR



TRESOR FIRST RELAX

- MOVIMENTO ELETTRICO SINCRONIZ. DELLO SCHIENALE, SEDILE E POGGIAGAMBE, VASCA N1 BIANCA, MISCEL. CON FORCELLA, CARTER ABS BIANCO, BRACCIOLI SLIM.
- ELECTRICAL SYNCHRONIZED MOVEMENT OF BACKREST, SEAT AND FOOTREST, WHITE BASIN N1, DROP-STOP SYSTEM, BACK COVER WHITE ABS, SLIM ARMREST.
- MOUVEMENT ÉLECTRIQUE SYNCHRONISÉ DU DOSSIER, DE L'ASSISE ET DU REPOSE-PIEDS, CUVETTE BLANCHE N1, MITIGEUR ANTI-GOUTTE, CACHE ABS BLANCHE, ACCOUDOIRS SLIM.
- SYNCHRONISIERTE BEWEGUNG DER RÜCKENLEHNE, SITZUNG UND BEINSTÜTZE, WEISS BECKEN N1, MISCHBATTERIE MIT DROP-STOP SYSTEM, WEISSE RÜCKGEHÄUSE, SLIM ARMLEHNEN.

COD. 510P



TRESOR FIRST JET MASSAGE

- MOVIMENTO ELETTR. SINCRONIZ. DELLO SCHIENALE, SEDILE E POGGIAGAMBE, MASSAGGIO JET, VASCA N1 BIANCA, MISCEL. CON FORCELLA, CARTER ABS BIANCO, BRACCIOLI SLIM.
- ELECTRICAL SYNCHRONIZED MOVEMENT OF BACKREST, SEAT AND FOOTREST, JET MASSAGE, WHITE BASIN N1, DROP-STOP SYSTEM, BACK COVER WHITE ABS, ARMREST SLIM.
- MOUVEMENT ÉLECTR. SYNCHRONISÉ DU DOSSIER, DE L'ASSISE ET DU REPOSE-PIEDS, JET MASSAGE, CUVETTE BLANCHE N1, MITIGEUR ANTI-GOUTTE, CACHE ABS BLANCHE, ACCOUDOIRS SLIM.
- SYNCHRONISIERTE BEWEGUNG DER RÜCKENLEHNE, SITZUNG UND BEINSTÜTZE, JET MASSAGE, WEISS BECKEN N1, MISCHBATTERIE MIT DROP-STOP SYSTEM, WEISSE RÜCKGEHÄUSE, SLIM ARMLEHNEN.

COD. 510M

COD. SPECIAL

- SKAI SPECIAL CON BRACCIOLI MID E SLIM.
- SPECIAL VINYL FOR ARMREST SLIM & MID.
- SKAI SPECIAL POUR ACCOUDOIR SLIM OU MID.
- SKAI SPECIAL MIT "MID" UND "SLIM" ARMLEHNEN.

COD. MID

- SUPPLEMENTO BRACCIOLI MID.
- ADDITIONAL PRICE FOR MID ARMRESTS.
- SUPPLEMENT POUR ACCOUDOIRS MID.
- ZUSCHLAG FÜR "MID" ARMLEHNEN

COD. 144

- PORTA DOSATORE
- SHAMPOO HOLDER
- PORTE-SHAMPOING
- FLASCHEHALTER

COD. G1

- VASCA G1 - NESSUN SUPPLEMENTO PREZZO
- BASIN G1 - NO EXTRA PRICE
- CUVETTE G1 - PAS DE SUPPLÉMENT DE PRIX
- WASCHBECKEN G1 - OHNE ZUSATZKOSTEN

COD. G3-N3

- SUPPL. LAVABO NERO G3-N3.
- EXTRA CHARGE BLACK G3-N3 BASIN.
- SUPPLÉMENT CUVETTE G3-N3 EN NOIR.
- AUFPREIS SCHWARZ BECKEN G3-N3.

COD. M0/400

- FODERINA SCHIENALE
- PLASTIC BACKREST COVER
- HOUSSE PROTECTION DOSSIER
- SCHUTZHÜLLE RÜCKENLEHNE

WEN LIFT

Carsat

- MOVIMENTO VERTICALE MOTORIZZATO
- VERTICAL MOTORIZED LIFT
- MOUVEMENT VERTICAL MOTORISÉ
- VERTIKALE MOTORISIERTER BEWEGUNG



- VERSIONI
- MODELS
- VERSIONS
- VERSIONEN

INSTALLAZIONE / INSTALLATION
INSTALLATION / INSTALLATION

TAPPEZZERIA / UPHOLSTERY
TAPISSERIE / POLSTER

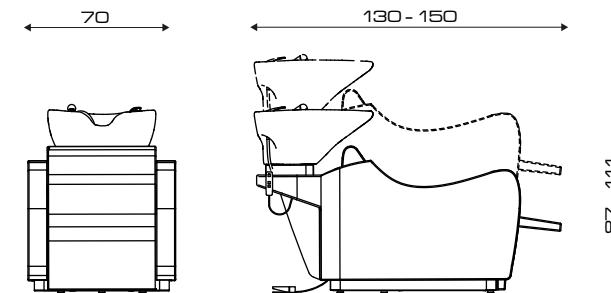

N1



G1

- ACCESSORI
- ACCESSORIES
- ACCESSOIRES
- ZUBEHÖR



WEN LIFT RELAX

- LAVAGGIO CON MOVIMENTO VERTICALE MOTORIZZATO, ALZAGAMBE ELETTRICO, VASCA "G1" BIANCA, MISCELATORE CON FORCELLA
- WASH UNIT WITH VERTICAL MOTORIZED LIFT, ELECTRIC LEGREST, WHITE BASIN "G1", DROP-STOP SYSTEM
- BAC DE LAVAGE AVEC MOUVEMENT VERTICAL MOTORISÉ, REP. JAMBES ELECT., CUVETTE BLANCHE "G1", MITIGEUR ANTI-GOUTTE
- WASCHANLAGE MIT VERTIKALE MOTORISIERTER BEWEGUNG, ELEKTRISCHE BEINAUFLAGE MIT "G1" WEISS BECKEN, MISCHBATTERIE MIT DROP-STOP SYSTEM.

COD. 542P



WEN LIFT SHIATSU MASSAGE

- MOVIMENTO VERTICALE MOTORIZZATO, MASSAGGIO SHIATSU AIR SOLO SCHIENA, ALZAGAMBE ELETTRICO, LAVABO "G" BIANCO, MISCEL. CON FORCELLA
- VERTICAL MOTORIZED LIFT, SHIATSU AIR MASSAGE BACKREST ONLY, ELECTRIC LEGREST, WHITE BASIN "G", DROP-STOP SYSTEM
- MOUVEMENT VERTICAL MOTORISÉ, SHIATSU AIR MASSAGE UNIQUEMENT SUR LE DOSSIER, REPOSE JAMBES, CUVETTE BLANCHE "G", MITIGEUR ANTI GOUTTE.
- VERTIKALE MOTORISIERTER BEWEGUNG, SHIATSU AIR MASSAGE NUR AUF DER RÜCKENLEHNE, ELEKTRISCHE BEINAUFLAGE MIT "G" WEISS BECKEN, MISCHBATTERIE MIT DROP-STOP SYSTEM.

COD. 542S



WEN LIFT JET MASSAGE

- LAVAGGIO CON MOV. VERTICALE MOTORIZZ., MASSAGGIO JET, ALZAGAMBE ELETTR., VASCA "G1" BIANCA, MISCEL. CON FORCELLA
- WASH UNIT WITH VERTICAL MOTORIZED LIFT, JET MASSAGE, ELECTRIC LEGREST, WHITE BASIN "G1", DROP-STOP SYSTEM
- BAC DE LAVAGE AVEC MOUVEMENT VERTICAL MOTORISÉ, JET MASSAGE, REP. JAMBES, CUVETTE. BLANCHE "G1", MITIGEUR ANTI GOUTTE.
- WASCHANLAGE MIT VERTIKALE MOTORISIERTER BEWEGUNG, JET MASSAGE, ELEKTRISCHE BEINAUFLAGE MIT "G1" WEISS BECKEN, MISCHBATTERIE MIT DROP-STOP SYSTEM.

COD. 542M

COD. SPECIAL

- SKAI SPECIAL
- SKAI SPECIAL
- SKAI SPECIAL
- SKAI SPECIAL

COD. M0/537

- FODERINA SCHIENALE
- PLASTIC BACKREST COVER
- HOUSSE PROTECTION DOSSIER
- SCHUTZHÜLLE RÜCKENLEHNE

COD. 176

- CUSCINO RIALZO H.5 CM
- CHILDREN CUSHION H.5 CM
- COUSSIN ENFANT POUR H.5 CM
- SITZUNG KISSEN H.5 CM

COD. SPECIAL

- SKAI SPECIAL PER CUSCINO
- SPECIAL VINYL FOR CUSHION
- SKAI SPECIAL POUR COUSSIN
- SKAI SPECIAL SITZUNG KISSEN

COD. N1

- VASCA N1 - NESSUN SUPPLEMENTO PREZZO
- BASIN N1 - NO EXTRA PRICE
- CUVETTE N1 - PAS DE SUPPLÉMENT DE PRIX
- WASCHBECKEN N1 - OHNE ZUSATZKOSTEN

COD. G3-N3

- SUPPL. LAVABO NERO G3-N3.
- EXTRA CHARGE BLACK G3-N3 BASIN.
- SUPPLÉMENT CUVETTE G3-N3 EN NOIR
- AUFPREIS SCHWARZ BECKEN G3-N3

COD. 144

- PORTA DOSATORE
- SHAMPOO HOLDER
- PORTE-SHAMPOOING
- FLASCHEHALTER

COD. OPTIMA

- VERSIONE OPTIMA BRACC. CON BORDINO.
- OPTIMA FINISHING ARMRESTS WITH PIPING.
- SUPPLÉM. ACCOUD. OPTIMA AVEC GALON.
- OPTIMA VERSION, ARMLEHNEN MIT KUNSTSTOFFLEDER

WEN PEDICHARM



- VERSIONI
- MODELS
- VERSIONS
- VERSIONEN

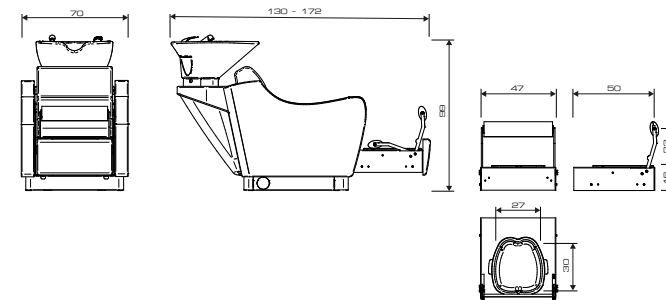

G1



N1

- ACCESSORI
- ACCESSORIES
- ACCESSOIRES
- ZUBEHÖR



WEN PEDICHARM

- LAVAGGIO FISSO, CASSETTO PER PEDICURE ESTRAIBILE, POGGIAPIEDI RECLINABILE E VASCHETTA RIMOVIBILE, LAVABO G BIANCO, CARTER POSTERIORE BIANCO, MISCELATORE CON FORCELLA **COD. 519.11**
- BACKWASH UNIT FIX, WITH PULL-OUT COMPARTMENT FOR PEDICURE, RECLINABLE FOOTREST AND REMOVABLE BOWL, WHITE "G" BASIN, WHITE REAR CARTER, MIXER WITH DROP-STOP SYSTEM.
- BAC DE LAVAGE FIX AVEC COMPARTIMENT EXTRACTIBLE POUR PEDICURE, REPOSE-PIEDS RECLINABLE ET BOL AMOVIBLE, CUVETTE G BLANCHE, CACHE POSTERIEUR BLANCHE, MITIGEUR ANTI-GOUTTE.
- WASCHANLAGE FEST, MIT AUSZIEHBAREM FACH FÜR PEDIKURE, VERSTELLBARER FUSS-STUTZE UND ABNEHMBARER KUNSTSCHALE, WEISS "G" BECKEN, WEISS RÜCKGEHAUSE, MISCHBATTERIE MIT DROP-STOP.

COD. SPECIAL

- SKAI SPECIAL
- SKAI SPÉCIAL
- SKAI SPÉCIAL
- SKAI SPECIAL

COD. M0/520

- FODERINA SCHIENALE
- PLASTIC BACKREST COVER
- HOUSSE PROTECTION DOSSIER
- SCHUTZHÜLLE RÜCKENLEHNE

COD. 177

- CUSCINO RIALZO H.5 CM
- CHILDREN CUSHION H.5 CM
- COUSSIN ENFANT POUR H.5 CM
- SITZUNG KISSEN H.5 CM

COD. SPECIAL

- SKAI SPECIAL PER CUSCINO
- SPECIAL VINYL FOR CUSHION
- SKAI SPÉCIAL POUR COUSSIN
- SKAI SPECIAL SITZUNG KISSEN

COD. N1

- VASCA N1 - NESSUN SUPPLEMENTO PREZZO
- BASIN N1 - NO EXTRA PRICE
- CUVETTE N1 - PAS DE SUPPLÉMENT DE PRIX
- WASCHBECKEN N1 - OHNE ZUSATZKOSTEN

COD. G3-N3

- SUPPL. LAVABO NERO G3-N3.
- EXTRA CHARGE BLACK G3-N3 BASIN.
- SUPPLÉMENT CUVETTE G3-N3 EN NOIR.
- AUFPREIS SCHWARZ BECKEN G3-N3.

COD. 144

- PORTA DOSATORE
- SHAMPOO HOLDER
- PORTE-SHAMPOING
- FLASCHEHALTER

WEN OPTIMA PEDICHARM

- TAPEZZATO CON BORDINO
- UPHOLSTERED WITH PIPING
- TAPISSÉ AVEC GALON
- GEPOLSTERT MIT KUNSTOFFKORDEL



- VERSIONI
- MODELS
- VERSIONS
- VERSIONEN

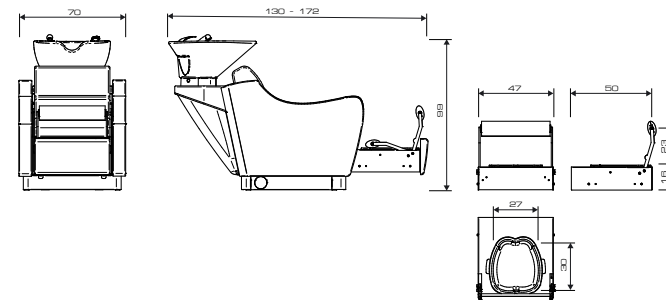

G1



N1

- ACCESSORI
- ACCESSORIES
- ACCESSOIRES
- ZUBEHÖR



WEN OPTIMA PEDICHARM

- LAVAGGIO FISSO, CASSETTO PER PEDICURE ESTRAIBILE, POGGIAPIEDI RECLINABILE E VASCHETTA RIMOVIBILE, LAVABO G BIANCO, CARTER POSTERIORE BIANCO, MISCELATORE CON FORCELLA
- BACKWASH UNIT FIX, WITH PULL-OUT COMPARTMENT FOR PEDICURE, RECLINABLE FOOTREST AND REMOVABLE BOWL, WHITE "G" BASIN, WHITE REAR CARTER, MIXER WITH DROP-STOP SYSTEM.
- BAC DE LAVAGE FIX AVEC COMPARTIMENT EXTRACTIBLE POUR PEDICURE, REPOSE-PIEDS RECLINABLE ET BOL AMOVIBLE, CUVETTE G BLANCHE, CACHE POSTERIEUR BLANCHE, MITIGEUR ANTI-GOUTTE.
- WASCHANLAGE FEST, MIT AUSZIEHBAREM FACH FÜR PEDIKURE, VERSTELLBARER FUSS-STUTZE UND ABNEHMBARER KUNSTSCHALE, WEISS "G" BECKEN, WEISS RUCKGEHAUSE, MISCHBATTERIE MIT DROP-STOP.

COD. 519B.11

COD. SPECIAL

- SKAI SPECIAL
- SKAI SPECIAL
- SKAI SPÉCIAL
- SKAI SPECIAL

COD. M0/520

- FODERINA SCHIENALE
- PLASTIC BACKREST COVER
- HOUSSE PROTECTION DOSSIER
- SCHUTZHÜLLE RÜCKENLEHNE

COD. 177

- CUSCINO RIALZO H.5 CM
- CHILDREN CUSHION H.5 CM
- COUSSIN ENFANT POUR H.5 CM
- SITZUNG KISSEN H.5 CM

COD. SPECIAL

- SKAI SPECIAL PER CUSCINO
- SPECIAL VINYL FOR CUSHION
- SKAI SPÉCIAL POUR COUSSIN
- SKAI SPECIAL SITZUNG KISSEN

COD. N1

- VASCA N1 - NESSUN SUPPLEMENTO PREZZO
- BASIN N1 - NO EXTRA PRICE
- CUVETTE N1 - PAS DE SUPPLÉMENT DE PRIX
- WASCHBECKEN N1 - OHNE ZUSATZKOSTEN

COD. G3-N3

- SUPPL. LAVABO NERO G3-N3.
- EXTRA CHARGE BLACK G3-N3 BASIN.
- SUPPLÉMENT CUVETTE G3-N3 EN NOIR
- AUFPREIS SCHWARZ BECKEN G3-N3

COD. 144

- PORTA DOSATORE
- SHAMPOO HOLDER
- PORTE-SHAMPOOING
- FLASCHEHALTER

WEN PRESTIGE PEDICHARM

- TAPEZZATO CON ROMBI LATERALI
- UPHOLSTERED WITH LATERAL RHOMBUS
- TAPISSE AVEC LOSANGES LATÉRALES
- GEPOLSTERT MIT SEITLICHEN RAUTEN

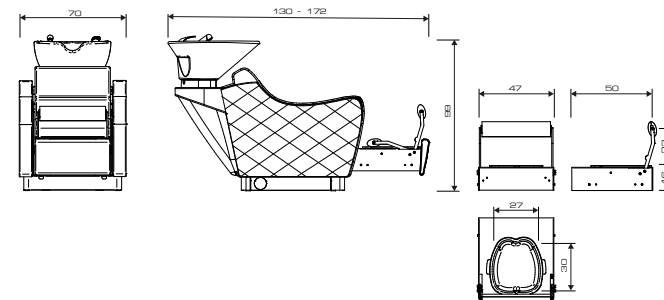

G1



N1

- VERSIONI
- MODELS
- VERSIONS
- VERSIONEN

- ACCESSORI
- ACCESSORIES
- ACCESSOIRES
- ZUBEHÖR



WEN PRESTIGE PEDICHARM

- LAVAGGIO FISSO, CASSETTO PER PEDICURE ESTRAIBILE, POGGIAPIEDI RECLINABILE E VASCHETTA RIMOVIBILE, LAVABO G BIANCO, CARTER POSTERIORE BIANCO, MISCELATORE CON FORCELLA
- BACKWASH UNIT FIX, WITH PULL-OUT COMPARTMENT FOR PEDICURE, RECLINABLE FOOTREST AND REMOVABLE BOWL, WHITE "G" BASIN, WHITE REAR CARTER, MIXER WITH DROP-STOP SYSTEM.
- BAC DE LAVAGE FIX AVEC COMPARTIMENT EXTRACTIBLE POUR PEDICURE, REPOSE-PIEDS RECLINABLE ET BOL AMOVIBLE, CUVETTE G BLANCHE, CACHE POSTERIEUR BLANCHE, MITIGEUR ANTI-GOUTTE.
- WASCHANLAGE FEST, MIT AUSZIEHBAREM FACH FÜR PEDIKURE, VERSTELLBARER FUSS-STUTZE UND ABNEHMBARER KUNSTSCHALE, WEISS "G" BECKEN, WEISS RÜCKGEHAUSE, MISCHBATTERIE MIT DROP-STOP.

COD. 540.11

COD. SPECIAL

- SKAI SPECIAL
- SKAI SPECIAL
- SKAI SPÉCIAL
- SKAI SPECIAL

COD. M0/520

- FODERINA SCHIENALE
- PLASTIC BACKREST COVER
- HOUSSE PROTECTION DOSSIER
- SCHUTZHÜLLE RÜCKENLEHNE

COD. 177

- CUSCINO RIALZO H.5 CM
- CHILDREN CUSHION H.5 CM
- COUSSIN ENFANT POUR H.5 CM
- SITZUNG KISSEN H.5 CM

COD. SPECIAL

- SKAI SPECIAL PER CUSCINO
- SPECIAL VINYL FOR CUSHION
- SKAI SPÉCIAL POUR COUSSIN
- SKAI SPECIAL SITZUNG KISSEN

COD. N1

- VASCA N1 - NESSUN SUPPLEMENTO PREZZO
- BASIN N1 - NO EXTRA PRICE
- CUVETTE N1 - PAS DE SUPPLÉMENT DE PRIX
- WASCHBECKEN N1 - OHNE ZUSATZKOSTEN

COD. G3-N3

- SUPPL. LAVABO NERO G3-N3.
- EXTRA CHARGE BLACK G3-N3 BASIN.
- SUPPLÉMENT CUVETTE G3-N3 EN NOIR
- AUFFREIS SCHWARZ BECKEN G3-N3

COD. 144

- PORTA DOSATORE
- SHAMPOO HOLDER
- PORTE-SHAMPOING
- FLASCHEHALTER

CAMACHO PEDICHARM

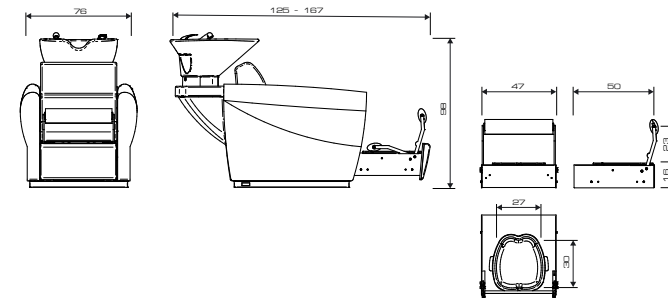

G1

N1

- VERSIONI
- MODELS
- VERSIONS
- VERSIONEN

- ACCESSORI
- ACCESSORIES
- ACCESSOIRES
- ZUBEHÖR



CAMACHO PEDICHARM

- LAVAGGIO FISSO, CASSETTO PER PEDICURE ESTRAIBILE, POGGIAPIEDI RECLINABILE E VASCHETTA RIMOVIBILE, LAVABO G BIANCO, CARTER POSTERIORE BIANCO, MISCELATORE CON FORCELLA
- BACKWASH UNIT FIX, WITH PULL-OUT COMPARTMENT FOR PEDICURE, RECLINABLE FOOTREST AND REMOVABLE BOWL, WHITE "G" BASIN, WHITE REAR CARTER, MIXER WITH DROP-STOP SYSTEM.
- BAC DE LAVAGE FIX AVEC COMPARTIMENT EXTRACTIBLE POUR PEDICURE, REPOSE-PIEDS RECLINABLE ET BOL AMOVIBLE, CUVETTE G BLANCHE, CACHE POSTERIEUR BLANCHE, MITIGEUR ANTI-GOUTTE.
- WASCHANLAGE FEST, MIT AUSZIEHBAREM FACH FÜR PEDIKURE, VERSTELLBARER FUSS-STUTZE UND ABNEHMBARER KUNSTSCHALE, WEISS "G" BECKEN, WEISS RÜCKGEHAUSE, MISCHBATTERIE MIT DROP-STOP.

COD. 536.11

COD. SPECIAL

- SKAI SPECIAL
- SKAI SPECIAL
- SKAI SPÉCIAL
- SKAI SPECIAL

COD. 177

- CUSCINO RIALZO H.5 CM
- CHILDREN CUSHION H.5 CM
- COUSSIN ENFANT POUR H.5 CM
- SITZUNG KISSEN H.5 CM

COD. SPECIAL

- SKAI SPECIAL PER COD. 177
- SKAI SPECIAL FOR COD. 177
- SKAI SPÉCIAL POUR COD. 177
- SKAI SPECIAL FÜR COD. 177

COD. M0/520

- FODERINA SCHIENALE
- PLASTIC BACKREST COVER
- HOUSSE PROTECTION DOSSIER
- SCHUTZHÜLLE RÜCKENLEHNE

COD. G1

- VASCA G1 - NESSUN SUPPLEMENTO PREZZO
- BASIN G1 - NO EXTRA PRICE
- CUVETTE G1 - PAS DE SUPPLÉMENT DE PRIX
- WASCHBECKEN G1 - OHNE ZUSATZKOSTEN

COD. G3-N3

- SUPPLEMENTO LAVABO NERO G3-N3
- EXTRA CHARGE BLACK G3-N3 BASIN.
- SUPPLÉMENT CUVETTE G3-N3 EN NOIR
- AUFFPREIS SCHWARZ BECKEN G3-N3

ZONE WASH PEDICHARM



- VERSIONI
- MODELS
- VERSIONS
- VERSIONEN

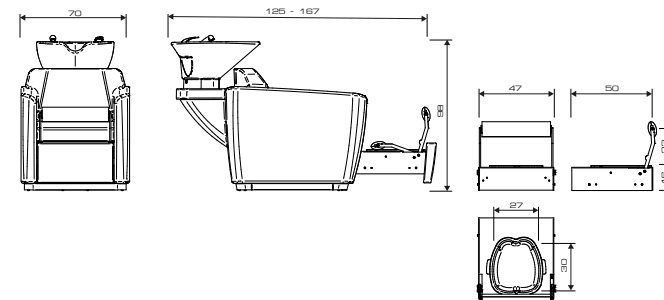

COD. 743-BI
[PAG. 180](#)



G1



N1

- ACCESSORI
- ACCESSORIES
- ACCESSOIRES
- ZUBEHÖR



ZONE WASH PEDICHARM

- LAVAGGIO FISSO, CASSETTO PER PEDICURE ESTRAIBILE, POGGIAPIEDI RECLINABILE E VASCHETTA RIMOVIBILE, LAVABO G BIANCO, CARTER POSTERIORE BIANCO, MISCELATORE CON FORCELLA
- BACKWASH UNIT FIX, WITH PULL-OUT COMPARTMENT FOR PEDICURE, RECLINABLE FOOTREST AND REMOVABLE BOWL, WHITE "G" BASIN, WHITE REAR CARTER, MIXER WITH DROP-STOP SYSTEM.
- BAC DE LAVAGE FIX AVEC COMPARTIMENT EXTRACTION POUR PEDICURE, REPOSE-PIEDS RECLINABLE ET BOL AMOVIBLE, CUVETTE G BLANCHE, CACHE POSTERIEUR BLANCHE, MITIGEUR ANTI-GOUTTE.
- WASCHANLAGE FEST, MIT AUSZIEHBAREM FACH FÜR PEDIKURE, VERSTELLBARER FUSS-STUTZE UND ABNEHMBARER KUNSTSCHALE, WEISS "G" BECKEN, WEISS RÜCKGEHAUSE, MISCHBATTERIE MIT DROP-STOP.

COD. 531.11

COD. SPECIAL

- SKAI SPECIAL
- SKAI SPÉCIAL
- SKAI SPÉCIAL
- SKAI SPECIAL

COD. M0/530

- FODERINA SCHIENALE
- PLASTIC BACKREST COVER
- HOUSSE PROTECTION DOSSIER
- SCHUTZHÜLLE RÜCKENLEHNE

COD. 177

- CUSCINO RIALZO H.5 CM
- CHILDREN CUSHION H.5 CM
- COUSSIN ENFANT POUR H.5 CM
- SITZUNG KISSEN H.5 CM

COD. SPECIAL

- SKAI SPECIAL PER CUSCINO
- SPECIAL VINYL FOR CUSHION
- SKAI SPÉCIAL POUR COUSSIN
- SKAI SPECIAL SITZUNG KISSEN

COD. N1

- VASCA N1 - NESSUN SUPPLEMENTO PREZZO
- BASIN N1 - NO EXTRA PRICE
- CUVETTE N1 - PAS DE SUPPLÉMENT DE PRIX
- WASCHBECKEN N1 - OHNE ZUSATZKOSTEN

COD. G3-N3

- SUPPL. LAVABO NERO G3-N3.
- EXTRA, CHARGE BLACK G3-N3 BASIN.
- SUPPLÉMENT CUVETTE G3-N3 EN NOIR.
- AUFREIS SCHWARZ BECKEN G3-N3.

LONDRA WASH PEDICHARM



COD. 547.11

- VERSIONI
- MODELS
- VERSIONS
- VERSIONEN



COD. 547.11 + OPTIMA

- ACCESSORI
- ACCESSORIES
- ACCESSOIRES
- ZUBEHÖR

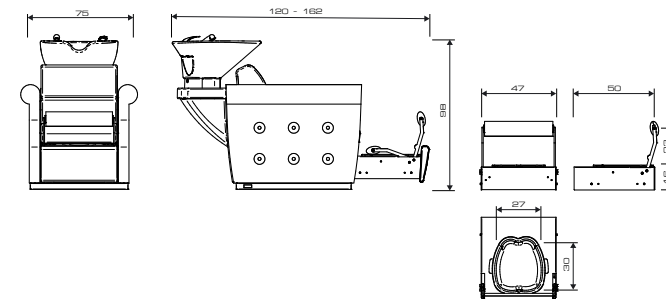

G1

N1



LONDRA WASH PEDICHARM

- LAVAGGIO FISSO, CASSETTO PER PEDICURE ESTRAIBILE, POGGIAPIEDI RECLINABILE E VASCHETTA RIMOVIBILE, LAVABO G BIANCO, CARTER POSTERIORE BIANCO, MISCELATORE CON FORCELLA
- BACKWASH UNIT FIX, WITH PULL-OUT COMPARTMENT FOR PEDICURE, RECLINABLE FOOTREST AND REMOVABLE BOWL, WHITE "G" BASIN, WHITE REAR CARTER, MIXER WITH DROP-STOP SYSTEM.
- BAC DE LAVAGE FIX AVEC COMPARTIMENT EXTRACTIBLE POUR PEDICURE, REPOSE-PIEDS RECLINABLE ET BOL AMOVIBLE, CUVETTE G BLANCHE, CACHE POSTERIEUR BLANCHE, MITIGEUR ANTI-GOUTTE.
- WASCHANLAGE FEST, MIT AUSZIEHBAREM FACH FÜR PEDIKURE, VERSTELLBARER FUSS-STUTZE UND ABNEHMBARER KUNSTSCHALE, WEISS "G" BECKEN, WEISS RÜCK-GEHAUSE, MISCHBATTERIE MIT DROP-STOP.

COD. 547.11

- COD. G1** •VASCA G1 - NESSUN SUPPLEMENTO PREZZO
- BASIN G1 - NO EXTRA PRICE
- CUVETTE G1 - PAS DE SUPPLÉMENT DE PRIX
- WASCHBECKEN G1 - OHNE ZUSATZKOSTEN

- COD. G3-N3** •SUPPLEMENTO PER LAVABO NERO G3-N3
- EXTRA CHARGE FOR BLACK G3-N3 BASIN.
- SUPPLÉMENT CUVETTE G3-N3 EN NOIR
- AUFPREIS SCHWARZ BECKEN G3-N3

- COD. SPECIAL** •SKAI SPECIAL
- SKAI SPECIAL
- SKAI SPECIAL
- SKAI SPECIAL

- COD. OPTIMA** •VERSIONE OPTIMA BRACC. CON BORDINO E BOTTONI
- OPTIMA VERSION WITH PIPING IN THE ARMRESTS AND BOTTONS
- "OPTIMA" ACCOUDOIRS AVEC PIPING ET BOUTONS
- OPTIMA VERSION, ARMLEHNE MIT KUNSTLEDERKORDEL UND KNÖPFEN

- COD. M0/520** •FODERINA SCHIENALE
- PLASTIC BACKREST COVER
- HOUSSE PROTECTION DOSSIER
- SCHUTZHÜLLE RÜCKENLEHNE

LONDRA WASH



COD. 547



COD. 547 + OPTIMA

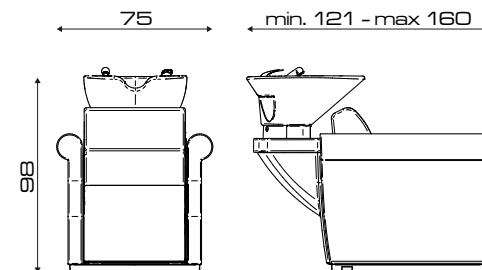

G1

N1

- VERSIONI
- MODELS
- VERSIONS
- VERSIONEN

- ACCESSORI
- ACCESSORIES
- ACCESSOIRES
- ZUBEHÖR



LONDRA WASH FIX

- FISSO CON VASCA N1 BIANCA, MISCELATORE CON FORCELLA
- FIX WITH WHITE BASIN N1, DROP-STOP SYSTEM
- FIX AVEC CUVETTE BLANCHE N1, MITIGEUR ANTI-GOUTTE
- FEST MIT N1 WEISS BECKEN, MISCHBATTERIE MIT DROP-STOP SYSTEM

COD. 547



LONDRA WASH RELAX

- ALZAGAMBE ELETTRICO, VASCA N1 BIANCA, MISCELATORE CON FORCELLA
- ELECTRIC LEGREST, WHITE BASIN N1, DROP-STOP SYSTEM
- REPOSE JAMBES EL., CUVETTE BLANCHE N1, MITIGEUR ANTI-GOUTTE
- ELEKTRISCHE BEINAUFLAGE MIT N1 WEISS BECKEN, MISCHBATTERIE MIT DROP-STOP SYSTEM

COD. 547P



LONDRA WASH JET MASSAGE

- MASSAGGIO JET, ALZAGAMBE EL., VASCA N1 BIANCA, MISCELATORE CON FORCELLA
- JET MASSAGE, ELECTRIC LEGREST, WHITE BASIN N1, DROP-STOP SYSTEM
- JET MASSAGE, REP. JAMBES, COUV. BLANCHE N1, MITIGEUR ANTI GOUTTE
- JET MASSAGE, ELEKTRISCHE BEINAUFLAGE MIT N1 WEISS BECKEN, MISCHBATTERIE MIT DROP-STOP SYSTEM

COD. 547M

- COD. G1** •VASCA G1 - NESSUN SUPPLEMENTO PREZZO
- BASIN G1 - NO EXTRA PRICE
- CUVETTE G1 - PAS DE SUPPLÉMENT DE PRIX
- WASCHBECKEN G1 - OHNE ZUSATZKOSTEN

- COD. G3-N3** •SUPPLEMENTO PER LAVABO NERO G3-N3
- EXTRA CHARGE FOR BLACK G3-N3 BASIN.
- SUPPLÉMENT CUVETTE G3-N3 EN NOIR
- AUFPREIS SCHWARZ BECKEN G3-N3

- COD. SPECIAL** •SKAI SPECIAL
- SKAI SPECIAL
- SKAI SPECIAL
- SKAI SPECIAL

- COD. OPTIMA** •VERSIONE OPTIMA BRACC. CON BORDINO E BOTTONI
- OPTIMA VERSION WITH PIPING IN THE ARMRESTS AND BOTTONS
- "OPTIMA" ACCOUDOIRS AVEC PIPING ET BOUTONS
- OPTIMA VERSION, ARMLEHNE MIT KUNSTLEDERKORDEL UND KNÖPFEN

- COD. M0/520** •FODERINA SCHIENALE
- PLASTIC BACKREST COVER
- HOUSSE PROTECTION DOSSIER
- SCHUTZHÜLLE RÜCKENLEHNE

CAMACHO



INSTALLAZIONE / INSTALLATION
INSTALLATION / INSTALLATION

TAPPEZZERIA / UPHOLSTERY
TAPISSERIE / POLSTER

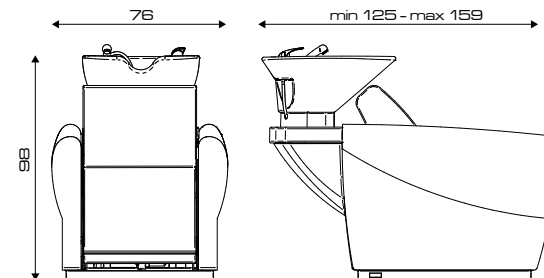

G1



N1

- VERSIONI
- MODELS
- VERSIONS
- VERSIONEN

- ACCESSORI
- ACCESSORIES
- ACCESSOIRES
- ZUBEHÖR



CAMACHO FIX

- FISSO CON VASCA "N1" BIANCA, MISCELATORE CON FORCELLA
- FIX WITH WHITE BASIN "N1", DROP-STOP SYSTEM
- FIX AVEC CUVETTE BLANCHE "N1", MITIGEUR ANTI-GOUTTE
- FEST MIT "N1" WEISS BECKEN, MISCHBATTERIE MIT DROP-STOP SYSTEM

COD. 536



CAMACHO RELAX

- ALZAGAMBE ELETTRICO, VASCA "N1" BIANCA, MISCELATORE CON FORCELLA
- ELECTRIC LEGREST, WHITE BASIN "N1", DROP-STOP SYSTEM
- REPOSE JAMBES EL., CUVETTE BLANCHE "N1", MITIGEUR ANTI-GOUTTE
- ELEKTRISCHE BEINAUFLAGE MIT "N1" WEISS BECKEN, MISCHBATTERIE MIT DROP-STOP SYSTEM

COD. 536P



CAMACHO JET MASSAGE

- MASSAGGIO JET, ALZAGAMBE EL., VASCA "N1" BIANCA, MISCELATORE CON FORCELLA
- JET MASSAGE, ELECTRIC LEGREST, WHITE BASIN "N1", DROP-STOP SYSTEM
- JET MASSAGE, REP. JAMBES, COUV. BLANCHE "N1", MITIGEUR ANTI GOUTTE
- JET MASSAGE, ELEKTRISCHE BEINAUFLAGE MIT "N1" WEISS BECKEN, MISCHBATTERIE MIT DROP-STOP SYSTEM

COD. 536M

COD. SPECIAL

- SKAI SPECIAL
- SKAI SPECIAL
- SKAI SPÉCIAL
- SKAI SPECIAL

COD. 177

- CUSCINO RIALZO H.5 CM
- CHILDREN CUSHION H.5 CM
- COUSSIN ENFANT POUR H.5 CM
- SITZUNG KISSEN H.5 CM

COD. SPECIAL

- SKAI SPECIAL PER COD. 177
- SKAI SPECIAL FOR COD. 177
- SKAI SPÉCIAL POUR COD. 177
- SKAI SPECIAL FUR COD. 177

COD. M0/520

- FODERINA SCHIENALE
- PLASTIC BACKREST COVER
- HOUSSE PROTECTION DOSSIER
- SCHUTZHÜLLE RÜCKENLEHNE

COD. G3-N3

- SUPPLEMENTO LAVABO NERO G3-N3
- EXTRA CHARGE BLACK G3-N3 BASIN.
- SUPPLÉMENT CUVETTE G3-N3 EN NOIR
- AUFPREIS SCHWARZ BECKEN G3-N3

COD. G1

- VASCA G1 - NESSUN SUPPLEMENTO PREZZO
- BASIN G1 - NO EXTRA PRICE
- CUVETTE G1 - PAS DE SUPPLÉMENT DE PRIX
- WASCHBECKEN G1 - OHNE ZUSATZKOSTEN

WEN CLASSIC



INSTALLAZIONE / INSTALLATION
INSTALLATION / INSTALLATION

TAPPEZZERIA / UPHOLSTERY
TAPISSERIE / POLSTER

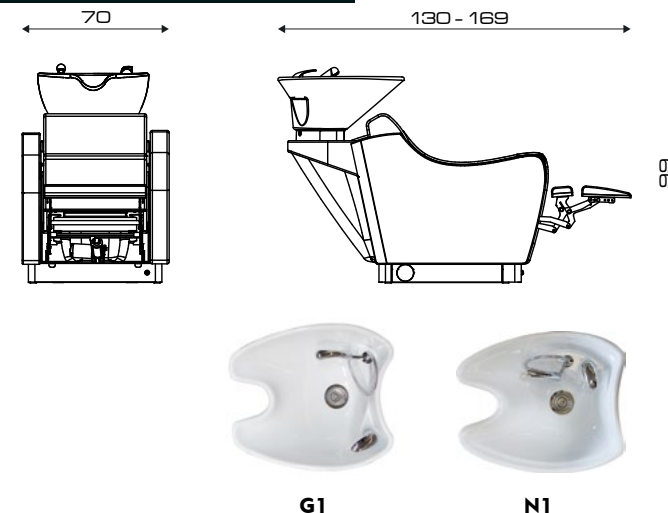

- VERSIONI
- MODELS
- VERSIONS
- VERSIONEN

- ACCESSORI
- ACCESSORIES
- ACCESSOIRES
- ZUBEHÖR



WEN CLASSIC FIX

- FISSO CON VASCA "G1" BIANCA, MISCELATORE CON FORCELLA
- FIX WITH WHITE BASIN "G1", DROP-STOP SYSTEM
- FIX AVEC CUVETTE BLANCHE "G1", MITIGEUR ANTI-GOUTTE
- FEST MIT "G1" WEISS BECKEN, MISCHBATTERIE MIT DROP-STOP SYSTEM

COD. 519



WEN CLASSIC RELAX

- ALZAGAMBE ELETTRICO, VASCA "G1" BIANCA, MISCELATORE CON FORCELLA
- ELECTRIC LEGREST, WHITE BASIN "G1", DROP-STOP SYSTEM
- REPOSE JAMBES EL., CUVETTE BLANCHE "G1", MITIGEUR ANTI-GOUTTE
- ELEKTRISCHE BEINAUFLAGE MIT "G1" WEISS BECKEN, MISCHBATTERIE MIT DROP-STOP SYSTEM

COD. 521



WEN CLASSIC JET MASSAGE

- MASSAGGIO JET, ALZAGAMBE EL., VASCA "G1" BIANCA, MISCELATORE CON FORCELLA
- JET MASSAGE, ELECTRIC LEGREST, WHITE BASIN "G1", DROP-STOP SYSTEM
- JET MASSAGE, REP. JAMBES, COUV. BLANCHE "G1", MITIGEUR ANTI GOUTTE
- JET MASSAGE, ELEKTRISCHE BEINAUFLAGE MIT "G1" WEISS BECKEN, MISCHBATTERIE MIT DROP-STOP SYSTEM

COD. 525

COD. SPECIAL

- SKAI SPECIAL
- SKAI SPÉCIAL
- SKAI SPÉCIAL
- SKAI SPECIAL

COD. M0/520

- FODERINA SCHIENALE
- PLASTIC BACKREST COVER
- HOUSSE PROTECTION DOSSIER
- SCHUTZHÜLLE RÜCKENLEHNE

COD. 177

- CUSCINO RIALZO H.5 CM
- CHILDREN CUSHION H.5 CM
- COUSSIN ENFANT POUR H.5 CM
- SITZUNG KISSEN H.5 CM

COD. SPECIAL

- SKAI SPECIAL PER CUSCINO
- SPECIAL VINYL FOR CUSHION
- SKAI SPÉCIAL POUR COUSSIN
- SKAI SPECIAL SITZUNG KISSEN

COD. N1

- VASCA N1 - NESSUN SUPPLEMENTO PREZZO
- BASIN N1 - NO EXTRA PRICE
- CUVETTE N1 - PAS DE SUPPLÉMENT DE PRIX
- WASCHBECKEN N1 - OHNE ZUSATZKOSTEN

COD. G3-N3

- SUPPL. LAVABO NERO G3-N3.
- EXTRA CHARGE BLACK G3-N3 BASIN.
- SUPPLÉMENT CUVETTE G3-N3 EN NOIR.
- AUFPREIS SCHWARZ BECKEN G3-N3.

COD. 144

- PORTA DOSATORE
- SHAMPOO HOLDER
- PORTE-SHAMPOOING
- FLASCHEHALTER

WEN OPTIMA

- TAPEZZATO CON BORDINO
- UPHOLSTERED WITH PIPING
- TAPISSÉ AVEC GALON
- GEPOLSTERT MIT KUNSTOFFKORDEL



INSTALLAZIONE / INSTALLATION
INSTALLATION / INSTALLATION

TAPPEZZERIA / UPHOLSTERY
TAPISSERIE / POLSTER
COD. 519B

TAPPEZZERIA / UPHOLSTERY
TAPISSERIE / POLSTER
COD. 521B/525B

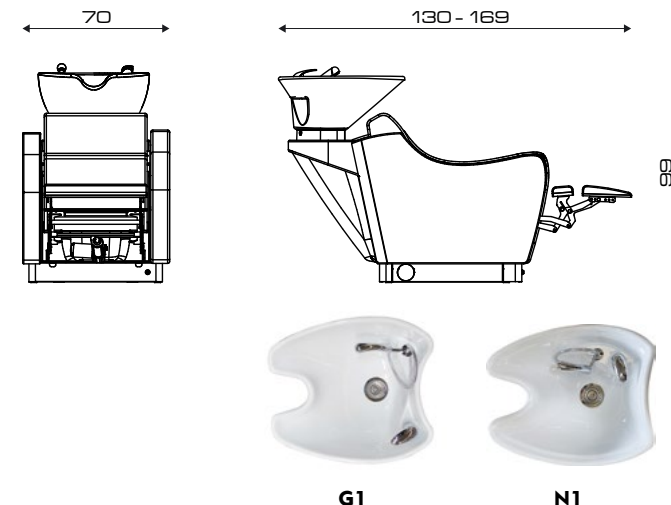

- VERSIONI
- MODELS
- VERSIONS
- VERSIONEN

- ACCESSORI
- ACCESSORIES
- ACCESSOIRES
- ZUBEHÖR



WEN OPTIMA FIX

- FISSO CON VASCA "G1" BIANCA, MISCELATORE CON FORCELLA
- FIX WITH WHITE BASIN "G1", DROP-STOP SYSTEM
- FIX AVEC CUVETTE BLANCHE "G1", MITIGEUR ANTI-GOUTTE
- FEST MIT "G1" WEISS BECKEN, MISCHBATTERIE MIT DROP-STOP SYSTEM

COD. 519B



WEN OPTIMA RELAX

- ALZAGAMBE ELETTRICO, VASCA "G1" BIANCA, MISCELATORE CON FORCELLA
- ELECTRIC LEGREST, WHITE BASIN "G1", DROP-STOP SYSTEM
- REPOSE JAMBES EL., CUVETTE BLANCHE "G1", MITIGEUR ANTI-GOUTTE
- ELEKTRISCHE BEINAUFLAGE MIT "G1" WEISS BECKEN, MISCHBATTERIE MIT DROP-STOP SYSTEM

COD. 521B



WEN OPTIMA JET MASSAGE

- MASSAGGIO JET, ALZAGAMBE EL., VASCA "G1" BIANCA, MISCELATORE CON FORCELLA
- JET MASSAGE, ELECTRIC LEGREST, WHITE BASIN "G1", DROP-STOP SYSTEM
- JET MASSAGE, REP. JAMBES, COUV. BLANCHE "G1", MITIGEUR ANTI GOUTTE
- JET MASSAGE, ELEKTRISCHE BEINAUFLAGE MIT "G1" WEISS BECKEN, MISCHBATTERIE MIT DROP-STOP SYSTEM

COD. 525B

COD. SPECIAL

- SKAI SPECIAL
- SKAI SPECIAL
- SKAI SPÉCIAL
- SKAI SPECIAL

COD. M0/520

- FODERINA SCHIENALE
- PLASTIC BACKREST COVER
- HOUSSE PROTECTION DOSSIER
- SCHUTZHÜLLE RÜCKENLEHNE

COD. 177

- CUSCINO RIALZO H.5 CM
- CHILDREN CUSHION H.5 CM
- COUSSIN ENFANT POUR H.5 CM
- SITZUNG KISSEN H.5 CM

COD. SPECIAL

- SKAI SPECIAL PER CUSCINO
- SPECIAL VINYL FOR CUSHION
- SKAI SPÉCIAL POUR COUSSIN
- SKAI SPECIAL SITZUNG KISSEN

COD. N1

- VASCA N1 - NESSUN SUPPLEMENTO PREZZO
- BASIN N1 - NO EXTRA PRICE
- CUVETTE N1 - PAS DE SUPPLÉMENT DE PRIX
- WASCHBECKEN N1 - OHNE ZUSATZKOSTEN

COD. G3-N3

- SUPPL. LAVABO NERO
- G3-N3.
- EXTRA CHARGE BLACK
- G3-N3 BASIN.
- SUPPLÉMENT CUVETTE G3-N3 EN NOIR
- AUFPREIS SCHWARZ BECKEN G3-N3

COD. 144

- PORTA DOSATORE
- SHAMPOO HOLDER
- PORTE-SHAMPOOING
- FLASCHEHALTER

WEN PRESTIGE

- TAPEZZATO CON ROMBI LATERALI
- UPHOLSTERED WITH LATERAL RHOMBUS
- TAPISSÉ AVEC LOSANGES LATÉRALES
- GEPOLSTERT MIT SEITLICHEN RAUTEN

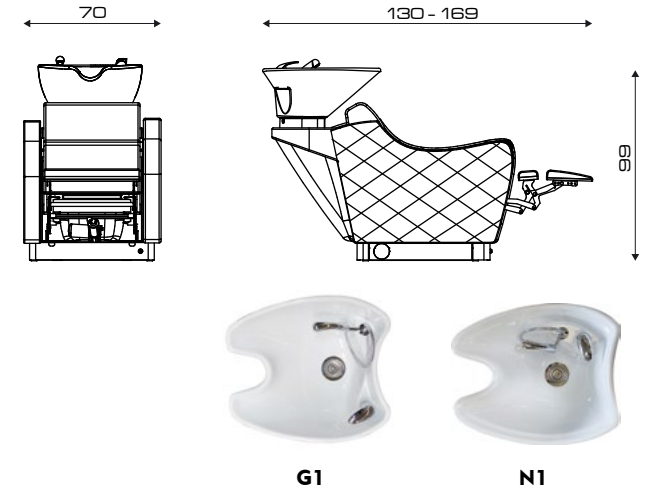

- VERSIONI
- MODELS
- VERSIONS
- VERSIONEN

- ACCESSORI
- ACCESSORIES
- ACCESSOIRES
- ZUBEHÖR



WEN PRESTIGE FIX

- FISSO CON VASCA "G1" BIANCA, MISCELATORE CON FORCELLA
- FIX WITH WHITE BASIN "G1", DROP-STOP SYSTEM
- FIX AVEC CUVETTE BLANCHE "G1", MITIGEUR ANTI-GOUTTE
- FEST MIT "G1" WEISS BECKEN, MISCHBATTERIE MIT DROP-STOP SYSTEM

COD. 540



WEN PRESTIGE RELAX

- ALZAGAMBE ELETTRICO, VASCA "G1" BIANCA, MISCELATORE CON FORCELLA
- ELECTRIC LEGREST, WHITE BASIN "G1", DROP-STOP SYSTEM
- REPOSE JAMBES EL., CUVETTE BLANCHE "G1", MITIGEUR ANTI-GOUTTE
- ELEKTRISCHE BEINAUFLAGE MIT "G1" WEISS BECKEN, MISCHBATTERIE MIT DROP-STOP SYSTEM

COD. 540P



WEN PRESTIGE JET MASSAGE

- MASSAGGIO JET, ALZAGAMBE EL., VASCA "G1" BIANCA, MISCELATORE CON FORCELLA
- JET MASSAGE, ELECTRIC LEGREST, WHITE BASIN "G1", DROP-STOP SYSTEM
- JET MASSAGE, REP. JAMBES, COUV. BLANCHE "G1", MITIGEUR ANTI GOUTTE
- JET MASSAGE, ELEKTRISCHE BEINAUFLAGE MIT "G1" WEISS BECKEN, MISCHBATTERIE MIT DROP-STOP SYSTEM

COD. 543

COD. SPECIAL

- SKAI SPECIAL
- SKAI SPECIAL
- SKAI SPÉCIAL
- SKAI SPECIAL

COD. M0/520

- FODERINA SCHIENALE
- PLASTIC BACKREST COVER
- HOUSSE PROTECTION DOSSIER
- SCHUTZHÜLLE RÜCKENLEHNE

COD. 177

- CUSCINO RIALZO H.5 CM
- CHILDREN CUSHION H.5 CM
- COUSSIN ENFANT POUR H.5 CM
- SITZUNG KISSEN H.5 CM

COD. SPECIAL

- SKAI SPECIAL PER CUSCINO
- SPECIAL VINYL FOR CUSHION
- SKAI SPÉCIAL POUR COUSSIN
- SKAI SPECIAL SITZUNG KISSEN

COD. N1

- VASCA N1 - NESSUN SUPPLEMENTO PREZZO
- BASIN N1 - NO EXTRA PRICE
- CUVETTE N1 - PAS DE SUPPLÉMENT DE PRIX
- WASCHBECKEN N1 - OHNE ZUSATZKOSTEN

COD. G3-N3

- SUPPL. LAVABO NERO G3-N3.
- EXTRA, CHARGE BLACK G3-N3 BASIN.
- SUPPLÉMENT CUVETTE G3-N3 EN NOIR
- AUFFPREIS SCHWARZ BECKEN G3-N3

COD. 144

- PORTA DOSATORE
- SHAMPOO HOLDER
- PORTE-SHAMPOOING
- FLASCHEHALTER

ZONE WASH CLASSIC



- VERSIONI
- MODELS
- VERSIONS
- VERSIONEN

- ACCESSORI
- ACCESSORIES
- ACCESSOIRES
- ZUBEHÖR

INSTALLAZIONE / INSTALLATION
INSTALLATION / INSTALLATION

TAPPEZZERIA / UPHOLSTERY
TAPISSERIE / POLSTER

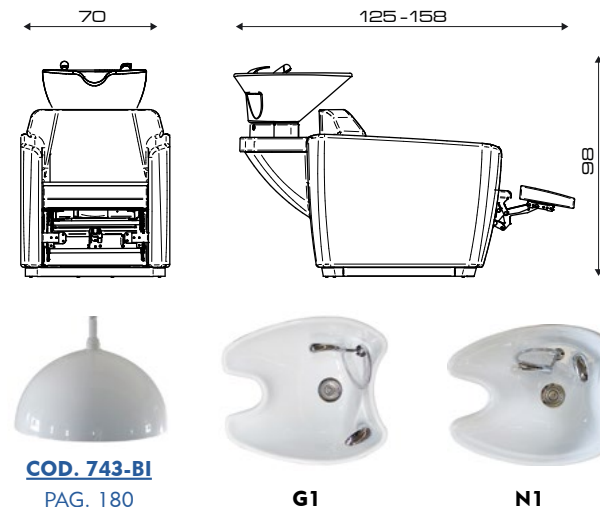

ZONE WASH CLASSIC FIX

- FISSO CON VASCA G1 BIANCA, MISCELATORE CON FORCELLA
- FIX WITH WHITE BASIN G1, DROP-STOP SYSTEM.
- FIX AVEC CUVETTE BLANCHE G1, MITIGEUR ANTI-GOUTTE
- FEST MIT G1 WEISS BECKEN, MISCHBATTERIE MIT DROP-STOP SYSTEM

COD. 531



ZONE WASH CLASSIC RELAX

- ALZAGAMBE ELETTRICO, VASCA G1 BIANCA, MISCELATORE CON FORCELLA
- ELECTRIC LEGREST, WHITE BASIN G1, DROP-STOP SYSTEM.
- REPOSE JAMBES EL., CUVETTE BLANCHE G1, MITIGEUR ANTI-GOUTTE
- ELEKTRISCHE BEINAUFLAGE MIT G1 WEISS BECKEN, MISCHBATTERIE MIT DROP-STOP SYSTEM

COD. 531P



ZONE WASH CLASSIC JET MASSAGE

- MASSAGGIO JET, ALZAGAMBE EL., VASCA G1 BIANCA, MISCELATORE CON FORCELLA
- JET MASSAGE, ELECTRIC LEGREST, WHITE BASIN G1, DROP-STOP SYSTEM
- JET MASSAGE, REP. JAMBES, COUV. BLANCHE G1, MITIGEUR ANTI GOUTTE
- JET MASSAGE, ELEKTRISCHE BEINAUFLAGE MIT G1 WEISS BECKEN, MISCHBATTERIE MIT DROP-STOP SYSTEM

COD. 535

COD. SPECIAL

- SKAI SPECIAL
- SKAI SPÉCIAL
- SKAI SPÉCIAL
- SKAI SPECIAL

COD. M0/530

- FODERINA SCHIENALE
- PLASTIC BACKREST COVER
- HOUSSE PROTECTION DOSSIER
- SCHUTZHÜLLE RÜCKENLEHNE

COD. 177

- CUSCINO RIALZO H.5 CM
- CHILDREN CUSHION H.5 CM
- COUSSIN ENFANT POUR H.5 CM
- SITZUNG KISSEN H.5 CM

COD. SPECIAL

- SKAI SPECIAL PER CUSCINO
- SPECIAL VINYL FOR CUSHION
- SKAI SPÉCIAL POUR COUSSIN
- SKAI SPECIAL SITZUNG KISSEN

COD. N1

- VASCA N1 - NESSUN SUPPLEMENTO PREZZO
- BASIN N1 - NO EXTRA PRICE
- CUVETTE N1 - PAS DE SUPPLÉMENT DE PRIX
- WASCHBECKEN N1 - OHNE ZUSATZKOSTEN

COD. G3-N3

- SUPPL. LAVABO NERO G3-N3.
- EXTRA CHARGE BLACK G3-N3 BASIN.
- SUPPLÉMENT CUVETTE G3-N3 EN NOIR.
- AUFREIS SCHWARZ BECKEN G3-N3.

WEN PRO



INSTALLAZIONE / INSTALLATION
INSTALLATION / INSTALLATION

TAPPEZZERIA / UPHOLSTERY
TAPISSERIE / POLSTER

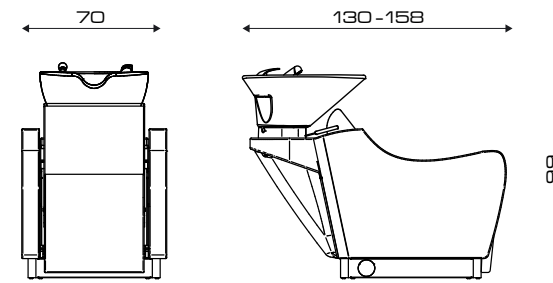

- VERSIONI
- MODELS
- VERSIONS
- VERSIONEN

- ACCESSORI
- ACCESSORIES
- ACCESSOIRES
- ZUBEHÖR



WEN PRO FIX

- FISSO CON VASCA G1 BIANCA, MISCELATORE CON FORCELLA
- FIX WITH WHITE BASIN G1, DROP-STOP SYSTEM
- FIX AVEC CUVETTE BLANCHE G1, MITIGEUR ANTI-GOUTTE
- FEST MIT "G1" WEISS BECKEN, MISCHBATTERIE MIT DROP-STOP SYSTEM

COD. 537



WEN PRO RELAX

- ALZAGAMBE ELETTRICO, VASCA G1 BIANCA, MISCELATORE CON FORCELLA
- ELECTRIC LEGREST, WHITE BASIN G1, DROP-STOP SYSTEM
- REPOSE JAMBES EL., CUVETTE BLANCHE G1, MITIGEUR ANTI-GOUTTE
- ELEKTRISCHE BEINAUFLAGE MIT G1 WEISS BECKEN, MISCHBATTERIE MIT DROP-STOP SYSTEM

COD. 537P



WEN PRO SHIATSU AIR

- MASSAGGIO SHIATSU AIR SOLO SCHIENA, ALZAGAMBE ELETTRICO, VASCA G1 BIANCA, MISCELATORE CON FORCELLA.
- SHIATSU AIR MASSAGE BACKREST ONLY, ELECTRIC LEGREST, WHITE BASIN G1, DROP-STOP SYSTEM.
- SHIATSU AIR MASSAGE UNIQUEMENT SUR LE DOSSIER, REPOSE JAMBES, CUVETTE BLANCHE G1, MITIGEUR ANTI GOUTTE.
- SHIATSU AIR MASSAGE NUR AUF DER RÜCKENLEHNE, ELEKTRISCHE BEINAUFLAGE MIT G1 BECKEN, MISCHBATTERIE MIT DROP-STOP SYSTEM.

COD. 537S



WEN PRO JET MASSAGE

- MASSAGGIO JET, ALZAGAMBE ELETTRICO, VASCA G1 BIANCA, MISCELATORE CON FORCELLA
- JET MASSAGE, ELECTRIC LEGREST, WHITE BASIN G1, DROP-STOP SYSTEM
- JET MASSAGE, REP JAMBES, COUV. BLANCHE G1, MITIGEUR ANTI GOUTTE
- JET MASSAGE, ELEKTRISCHE BEINAUFLAGE MIT G1 WEISS BECKEN, MISCHBATTERIE MIT DROP-STOP SYSTEM

COD. 537M

COD. SPECIAL

- SKAI SPECIAL
- SKAI SPECIAL
- SKAI SPÉCIAL
- SKAI SPECIAL

COD. M0/537

- FODERINA SCHIENALE
- PLASTIC BACKREST COVER
- HOUSSE PROTECTION DOSSIER
- SCHUTZHÜLLE RÜCKENLEHNE

COD. 176

- CUSCINO RIALZO H.5 CM
- CHILDREN CUSHION H.5 CM
- COUSSIN ENFANT POUR H.5 CM
- SITZUNG KISSEN H.5 CM

COD. SPECIAL

- SKAI SPECIAL PER CUSCINO
- SPECIAL VINYL FOR CUSHION
- SKAI SPÉCIAL POUR COUSSIN
- SKAI SPECIAL SITZUNG KISSEN

COD. N1

- VASCA N1 - NESSUN SUPPLEMENTO PREZZO
- BASIN N1 - NO EXTRA PRICE
- CUVETTE N1 - PAS DE SUPPLÉMENT DE PRIX
- WASCHBECKEN N1 - OHNE ZUSATZKOSTEN

COD. G3-N3

- SUPPL. LAVABO NERO G3-N3.
- EXTRA CHARGE BLACK G3-N3 BASIN.
- SUPPLÉMENT CUVETTE G3-N3 EN NOIR
- AUFPREIS SCHWARZ BECKEN G3-N3

COD. 144

- PORTA DOSATORE
- SHAMPOO HOLDER
- PORTE-SHAMPOOING
- FLASCHEHALTER

COD. OPTIMA

- VERSIONE OPTIMA BRACC. CON BORDINO.
- OPTIMA FINISHING ARMRESTS WITH PIPING.
- SUPPLÉM. ACCOUD. OPTIMA AVEC GALON.
- OPTIMA VERSION, ARMLEHNEN MIT KUNSTOFFLEDER

ZONE WASH PRO



INSTALLAZIONE / INSTALLATION
INSTALLATION / INSTALLATION

TAPPEZZERIA / UPHOLSTERY
TAPISSERIE / POLSTER

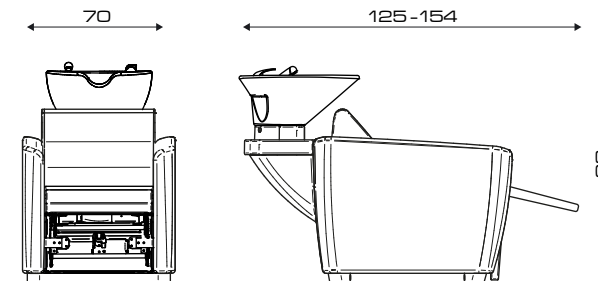

G1



N1

- VERSIONI
- MODELS
- VERSIONS
- VERSIONEN

- ACCESSORI
- ACCESSORIES
- ACCESSOIRES
- ZUBEHÖR



ZONE WASH PRO FIX

- FISSO CON VASCA G1 BIANCA, MISCELATORE CON FORCELLA
- FIX WITH WHITE BASIN G1, DROP-STOP SYSTEM
- FIX AVEC CUVETTE BLANCHE G1, MITIGEUR ANTI-GOUTTE
- FEST MIT "G1" WEISS BECKEN, MISCHBATTERIE MIT DROP-STOP SYSTEM

COD. 541



ZONE WASH PRO RELAX

- ALZAGAMBE ELETTRICO, VASCA G1 BIANCA, MISCELATORE CON FORCELLA
- ELECTRIC LEGREST, WHITE BASIN G1, DROP-STOP SYSTEM
- REPOSE JAMBES EL., CUVETTE BLANCHE G1, MITIGEUR ANTI-GOUTTE
- ELEKTRISCHE BEINAUFLAGE MIT G1 WEISS BECKEN, MISCHBATTERIE MIT DROP-STOP SYSTEM

COD. 541P



ZONE WASH PRO SHIATSU AIR

- MASSAGGIO SHIATSU AIR SOLO SCHIENA, ALZAGAMBE ELETTRICO, VASCA G1 BIANCA, MISCELATORE CON FORCELLA.
- SHIATSU AIR MASSAGE BACKREST ONLY, ELECTRIC LEGREST, WHITE BASIN G1, DROP-STOP SYSTEM.
- SHIATSU AIR MASSAGE UNIQUEMENT SUR LE DOSSIER, REPOSE JAMBES, CUVETTE BLANCHE G1, MITIGEUR ANTI GOUTTE.
- SHIATSU AIR MASSAGE NUR AUF DER RÜCKENLEHNE, ELEKTRISCHE BEINAUFLAGE MIT G1 BECKEN, MISCHBATTERIE MIT DROP-STOP SYSTEM.

COD. 541S



ZONE WASH PRO JET MASSAGE

- MASSAGGIO JET, ALZAGAMBE ELETTRICO, VASCA G1 BIANCA, MISCELATORE CON FORCELLA
- JET MASSAGE, ELECTRIC LEGREST, WHITE BASIN G1, DROP-STOP SYSTEM
- JET MASSAGE, REP JAMBES, COUV. BLANCHE G1, MITIGEUR ANTI GOUTTE
- JET MASSAGE, ELEKTRISCHE BEINAUFLAGE MIT G1 WEISS BECKEN, MISCHBATTERIE MIT DROP-STOP SYSTEM

COD. 541M

COD. SPECIAL

- SKAI SPECIAL
- SKAI SPECIAL
- SKAI SPÉCIAL
- SKAI SPECIAL

COD. M0/537

- FODERINA SCHIENALE
- PLASTIC BACKREST COVER
- HOUSSE PROTECTION DOSSIER
- SCHUTZHÜLLE RÜCKENLEHNE

COD. 176

- CUSCINO RIALZO H.5 CM
- CHILDREN CUSHION H.5 CM
- COUSSIN ENFANT POUR H.5 CM
- SITZUNG KISSEN H.5 CM

COD. SPECIAL

- SKAI SPECIAL PER CUSCINO
- SPECIAL VINYL FOR CUSHION
- SKAI SPÉCIAL POUR COUSSIN
- SKAI SPECIAL SITZUNG KISSEN

COD. N1

- VASCA N1 - NESSUN SUPPLEMENTO PREZZO
- BASIN N1 - NO EXTRA PRICE
- CUVETTE N1 - PAS DE SUPPLÉMENT DE PRIX
- WASCHBECKEN N1 - OHNE ZUSATZKOSTEN

COD. G3-N3

- SUPPL. LAVABO NEROG3-N3.
- EXTRA CHARGE BLACK G3-N3 BASIN
- SUPPLÉMENT CUVETTE G3-N3 EN NOIR
- AUFPREIS SCHWARZ BECKEN G3-N3

ZONE WASH PRO OPTIMA

INSTALLAZIONE / INSTALLATION
INSTALLATION / INSTALLATION

TAPPEZZERIA / UPHOLSTERY
TAPISSERIE / POLSTER



70

125 - 154

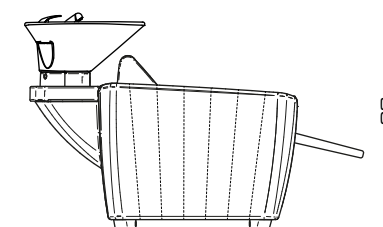
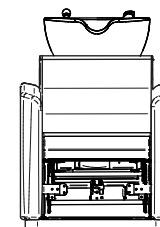

G1



N1

- VERSIONI
- MODELS
- VERSIONS
- VERSIONEN

- ACCESSORI
- ACCESSOIRES
- ACCESSOIRES
- ZUBEHÖR



ZONE WASH PRO OPTIMA FIX

- FISSO CON VASCA G1 BIANCA, MISCELATORE CON FORCELLA
- FIX WITH WHITE BASIN G1, DROP-STOP SYSTEM
- FIX AVEC CUVETTE BLANCHE G1, MITIGEUR ANTI-GOUTTE
- FEST MIT "G1" WEISS BECKEN, MISCHBATTERIE MIT DROP-STOP SYSTEM

COD. 549



ZONE WASH PRO OPTIMA RELAX

- ALZAGAMBE ELETTRICO, VASCA G1 BIANCA, MISCELATORE CON FORCELLA
- ELECTRIC LEGREST, WHITE BASIN G1, DROP-STOP SYSTEM
- REPOSE JAMBES EL., CUVETTE BLANCHE G1, MITIGEUR ANTI-GOUTTE
- ELEKTRISCHE BEINAUFLAGE MIT G1 WEISS BECKEN, MISCHBATTERIE MIT DROP-STOP SYSTEM

COD. 549P



ZONE WASH PRO OPTIMA JET MASSAGE

- MASSAGGIO JET, ALZAGAMBE ELETTRICO, VASCA G1 BIANCA, MISCELATORE CON FORCELLA
- JET MASSAGE, ELECTRIC LEGREST, WHITE BASIN G1, DROP-STOP SYSTEM
- JET MASSAGE, REP. JAMBES, COUV. BLANCHE G1, MITIGEUR ANTI GOUTTE
- JET MASSAGE, ELEKTRISCHE BEINAUFLAGE MIT G1 WEISS BECKEN, MISCHBATTERIE MIT DROP-STOP SYSTEM

COD. 549M

COD. SPECIAL

- SKAI SPECIAL
- SKAI SPECIAL
- SKAI SPÉCIAL
- SKAI SPECIAL

COD. M0/537

- FODERINA SCHIENALE
- PLASTIC BACKREST COVER
- HOUSSE PROTECTION DOSSIER
- SCHUTZHÜLLE RÜCKENLEHNE

COD. 176

- CUSCINO RIALZO H.5 CM
- CHILDREN CUSHION H.5 CM
- COUSSIN ENFANT POUR H.5 CM
- SITZUNG KISSEN H.5 CM

COD. SPECIAL

- SKAI SPECIAL PER CUSCINO
- SPECIAL VINYL FOR CUSHION
- SKAI SPÉCIAL POUR COUSSIN
- SKAI SPECIAL SITZUNG KISSEN

COD. N1

- VASCA N1 - NESSUN SUPPLEMENTO PREZZO
- BASIN N1 - NO EXTRA PRICE
- CUVETTE N1 - PAS DE SUPPLÉMENT DE PRIX
- WASCHBECKEN N1 - OHNE ZUSATZKOSTEN

COD. G3-N3

- SUPPL. LAVABO NERO G3-N3.
- EXTRA CHARGE BLACK G3-N3 BASIN.
- SUPPLÉMENT CUVETTE G3-N3 EN NOIR.
- AUFREIS SCHWARZ BECKEN G3-N3.

TRESOR MODULO



COD: 507



COD: 507+502D+502S



COD: 507+503D+503S

INSTALLAZIONE / INSTALLATION
INSTALLATION / INSTALLATION

TAPPEZZERIA / UPHOLSTERY
TAPISSERIE / POLSTER
COD. 507+503D+503S

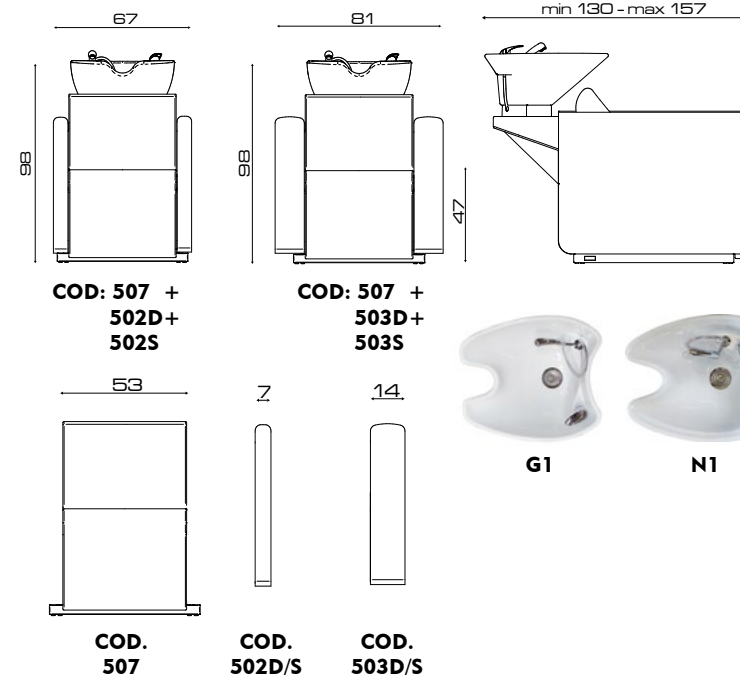

VERSIONI - MODELS - VERSIONS - VERSIONEN

ACCESSORI - ACCESSORIES - ACCESSOIRES - ZUBEHÖR



TRESOR MODULO FIX

COD. 507

- FISSO CON VASCA N1 BIANCA, MISCELATORE CON FORCELLA
- FIX WITH WHITE BASIN N1, DROP-STOP SYSTEM
- FIX AVEC CUVETTE BLANCHE N1, MITIGEUR ANTI-GOUTTE
- FEST MIT N1 WEISS BECKEN, MISCHBATTERIE MIT DROP-STOP SYSTEM



TRESOR MODULO RELAX

COD. 507P

- ALZAGAMBE ELETTRICO, VASCA N1 BIANCA, MISCELATORE CON FORCELLA
- ELECTRIC LEGREST, WHITE BASIN N1, DROP-STOP SYSTEM
- REPOSE JAMBES EL., CUVETTE BLANCHE N1, MITIGEUR ANTI-GOUTTE
- ELEKTRISCHE BEINAUFLAGE MIT N1 WEISS BECKEN, MISCHBATTERIE MIT DROP-STOP SYSTEM



TRESOR MODULO JET MASSAGE

COD. 507M

- MASSAGGIO JET, ALZAGAMBE EL., VASCA N1 BIANCA, MISCELATORE CON FORCELLA
- JET MASSAGE, ELECTRIC LEGREST, WHITE BASIN N1, DROP-STOP SYSTEM
- JET MASSAGE, REP JAMBES, COUV. BLANCHE N1, MITIGEUR ANTI GOUTTE
- JET MASSAGE, ELEKTRISCHE BEINAUFLAGE MIT N1 WEISS BECKEN, MISCHBATTERIE MIT DROP-STOP SYSTEM

COD. SPECIAL

- SKAI SPECIAL COD. 507/507P/507M
- SKAI SPECIAL COD. 507/507P/507M
- SKAI SPECIAL COD. 507/507P/507M
- SKAI SPECIAL COD. 507/507P/507M

COD. G1

- VASCA G1 - NESSUN SUPPLEMENTO PREZZO
- BASIN G1 - NO EXTRA PRICE
- CUVETTE G1 - PAS DE SUPPLÉMENT DE PRIX
- WASHBECKEN G1 - OHNE ZUSATZKOSTEN

COD. G3-N3

- SUPPLEMENTO LAVABO NERO G3-N3
- EXTRA CHARGE BLACK G3-N3 BASIN
- SUPPLÉMENT CUVETTE G3-N3 EN NOIR
- AUFPREIS SCHWARZ BECKEN G3-N3

COD. 502D

- BRACC. SLIM DESTRO 7 CM, RIVESTITO.
- ARMREST SLIM RIGHT SIDE 7 CM, UPHOLSTERED.
- ACCOUDOIR SLIM CÔTÉ DROITE 7 CM, TAPISSÉ.
- GEPOLSTERTE RECHTE ARMLEHNE "SLIM", 7 CM.

COD. 502S

- BRACC. SLIM SINISTRO 7 CM, RIVESTITO.
- ARMREST SLIM LEFT SIDE 7 CM, UPHOLSTERED.
- ACCOUDOIR SLIM CÔTÉ GAUCHE 7 CM, TAPISSÉ.
- GEPOLSTERTE LINKE ARMLEHNE "SLIM", 7 CM.

COD. 503D

- BRACC. "MID" 14 CM, DESTRO O CENTRALE, RIVESTITO.
- ARMREST "MID" 14 CM, RIGHT SIDE OR CENTRAL, UPHOLSTERED.
- ACCOUDOIR "MID" 14 CM, CÔTÉ DROITE OU CENTRAL, TAPISSÉ.
- GEPOLSTERTE ARMLEHNE "MID" 14 CM, RECHTE ODER ZENTRAL.

COD. 503S

- BRACC. "MID" 14 CM, SINISTRO O CENTRALE, RIVESTITO.
- ARMREST "MID" 14 CM, LEFT SIDE OR CENTRAL, UPHOLSTERED.
- ACCOUDOIR "MID" 14 CM, CÔTÉ GAUCHE OU CENTRAL, TAPISSÉ.
- GEPOLSTERTE ARMLEHNE "MID" 14 CM, LINKE ODER ZENTRAL.

COD. SPECIAL

- SKAI SPECIAL PER BRACC. MID E SLIM CAD.
- SPECIAL VINYL FOR ARMREST SLIM & MID/EACH
- SKAI SPECIAL POUR ACCOUDOIR SLIM OUMID/PAR PIECE
- SKAI SPECIAL FÜR ARMLEHNEN "MID" UND "SLIM", JEDER.

COD. M0/537

- FODERINA SCHIENALE
- PLASTIC BACKREST COVER
- HOUSSE PROTECTION DOSSIER
- SCHUTZHÜLLE RÜCKENLEHNE

PASHÀ 1 POSTO



INSTALLAZIONE / INSTALLATION
INSTALLATION / INSTALLATION

TAPPEZZERIA / UPHOLSTERY
TAPISSERIE / POLSTER

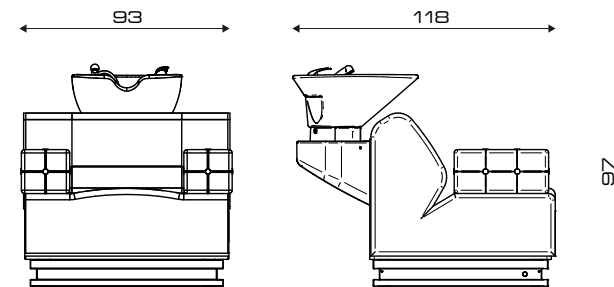

G1

- VERSIONI
- MODELS
- VERSIONS
- VERSIONEN

- ACCESSORI
- ACCESSORIES
- ACCESSOIRES
- ZUBEHÖR



PASHA' 1 POSTO / 1 SEAT / 1 PLACE / 1 PLATZ

COD. 529

- PASHA' 1 POSTO FISSO CON VASCA G1 BIANCA, MISCELATORE CON FORCELLA, CARTER ABS BIANCO.
- PASHA' 1 SEAT FIX WITH WHITE BASIN G1, DROP-STOP SYSTEM, BACK COVER WHITE ABS.
- PASHA 1 PLACE FIX AVEC CUVETTE BLANCHE G1, MITIGEUR ANTI-GOUTTE, CACHE ABS BLANCHE.
- PASHA 1 PLATZ FEST MIT G1 WEISS BECKEN, MISCHBATTERIE MIT DROP-STOP SYSTEM

COD. LED

- LUCE LED
- LED LIGHT
- LED LUMIÈRE
- LED-LICHT

COD. SPECIAL

- SKAI SPECIAL
- SKAI SPÉCIAL
- SKAI SPÉCIAL
- SKAI SPECIAL

COD. M0/529

- FODERINA SCHIENALE
- PLASTIC BACKREST COVER
- HOUSSE PROTECTION DOSSIER
- SCHUTZHÜLLE RÜCKENLEHNE

COD. JET MASSAGE

- JET MASSAGE 1 POSTO
- JET MASSAGE 1 SEAT
- MASSAGE JET 1 PLACE
- JET MASSAGE 1 PLATZ

COD. G3-N3

- SUPPLEMENTO LAVABO NERO G3
- EXTRA CHARGE BLACK G3 BASIN
- SUPPLÉMENT CUVETTE G3 EN NOIR
- AUFPREIS SCHWARZ BECKEN G3

COD. FIN. DIAMOND

- FINITURA CON BOTTONI EFFETTO DIAMANTE
- VERSION WITH BUTTONS "DIAMONDS" EFFECT
- BOUTONS EFFET "DIAMANTS"
- DIAMANT EFFET TASTEN

COD. 465

- SUPPLEMENTO MISCELATORE TERMOSTATICO CON FORCELLA.
- PRICE SUPPLEMENT THERMOSTATIC WATER MIXER WITH DROP-STOP SYSTEM.
- SUPPLEMENT MITIGEUR THERMOSTATIQUE AVEC SYSTÈME ANTI-GOUTTE.
- AUFPREIS FÜR TERMOSTATISCHE MISCHBATTERIE MIT "DROP-STOP" SYSTEM.

PASHÀ 2 POSTI



INSTALLAZIONE / INSTALLATION
INSTALLATION / INSTALLATION

TAPPEZZERIA / UPHOLSTERY
TAPISSERIE / POLSTER

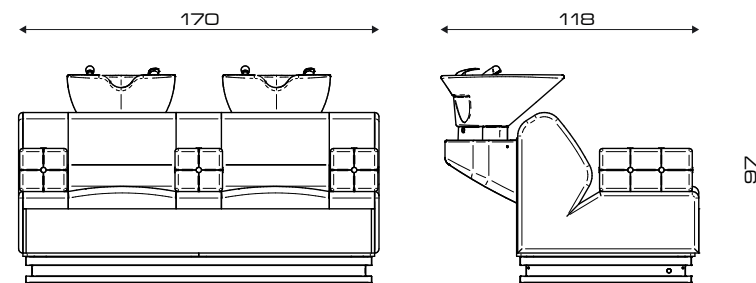

G1

- VERSIONI
- MODELS
- VERSIONS
- VERSIONEN

- ACCESSORI
- ACCESSORIES
- ACCESSOIRES
- ZUBEHÖR



PASHA' 2 POSTI / 2 SEATS / 2 PLACES / 2 PLÄTZE

COD. 526

- PASHA' 2 POSTI FISSI CON VASCA "G1" BIANCA, MISCELATORE CON FORCELLA, CARTER ABS BIANCO.
- PASHA' 2 SEATS FIX WITH WHITE BASIN "G1", DROP-STOP SYSTEM, BACK COVER WHITE ABS.
- PASHA' 2 PLACES FIX AVEC CUVETTE BLANCHE "G1", MITIGEUR ANTI-GOUTTE, CACHE ABS BLANCHE.
- PASHA' 2 PLATZ FEST MIT "G1" WEISS BECKEN, MISCHBATTERIE MIT "DROP-STOP"SYSTEM

COD. LED

- LUCE LED
- LED LIGHT
- LED LUMIÈRE
- LED-LICHT

COD. SPECIAL

- SKAI SPECIAL
- SKAI SPECIAL
- SKAI SPÉCIAL
- SKAI SPECIAL

COD. M0/526

- FODERINA SCHIENALE
- PLASTIC BACKREST COVER
- HOUSSE PROT. DOSSIER
- SCHUTZHÜLLE RÜCKENLEHNE

COD. JET MASSAGE

- JET MASSAGE 2 POSTI
- JET MASSAGE 2 SEATS
- MASSAGE JET 2 PLACES
- JET MASSAGE 2 PLATZ

COD. G3-N3

- SUPPLEMENTO PER 2 LAVABI NERI G3
- EXTRA CHARGE FOR 2 BLACK G3 BASINS
- SUPPLÉMENT POUR 2 CUVETTES G3 NOIRE
- AUFPREIS 2 SCHWARZEN BECKEN G3

COD. FIN. DIAMOND

- FINITURA CON BOTTONI EFFETTO DIAMANTE
- VERSION WITH BUTTONS "DIAMONDS" EFFECT
- BOUTONS EFFET "DIAMANTS"
- DIAMANT EFFET TASTEN

COD. 465

- SUPPLEMENTO PER 2 MISCELATORI TERMOSTATICI CON FORCELLA.
- PRICE SUPPLEMENT FOR 2 THERMOSTATIC WATER MIXER WITH DROP-STOP SYSTEM.
- SUPPLÉMENT POUR 2 MITIGEURS THERMOSTATIQUE AVEC SYSTÈME ANTI-GOUTTE.
- AUFPREIS FÜR 2 TERMOSTATISCHE MISCHBATTERIEN MIT "DROP-STOP" SYSTEM.

PASHÀ 3 POSTI

INSTALLAZIONE / INSTALLATION
INSTALLATION / INSTALLATION

TAPPEZZERIA / UPHOLSTERY
TAPISSERIE / POLSTER

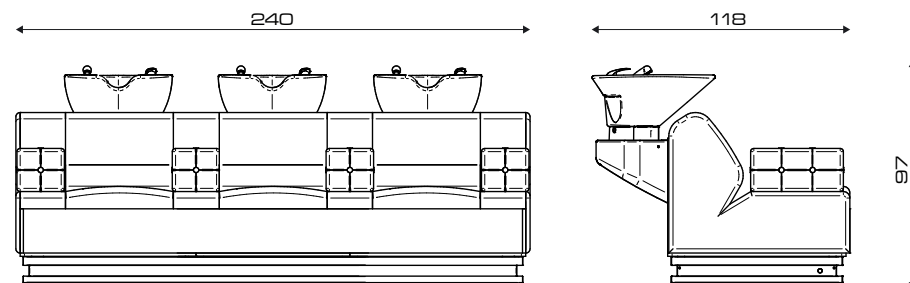

G1

- VERSIONI
- MODELS
- VERSIONS
- VERSIONEN

- ACCESSORI
- ACCESSORIES
- ACCESSOIRES
- ZUBEHÖR



PASHÀ 3 POSTI / 3 SEATS / 3 PLACES / 3 PLÄTZE

COD. 527

- PASHÀ 3 POSTI FISSI CON VASCA G1 BIANCA, MISCELATORE CON FORCELLA, CARTER ABS BIANCO.
- PASHÀ 3 SEATS FIX WITH WHITE BASIN G1, DROP-STOP SYSTEM, BACK COVER WHITE ABS.
- PASHÀ 3 PLACES FIX AVEC CUVETTE BLANCHE G1, MITIGEUR ANTI-GOUTTE, CACHE ABS BLANCHE.
- PASHÀ 3 PLATZ FEST MIT G1 WEISS BECKEN, MISCHBATTERIE MIT DROP-STOP SYSTEM

COD. LED

- LUCE LED
- LED LIGHT
- LED LUMIÈRE
- LED-LICHT

COD. SPECIAL

- SKAI SPECIAL
- SKAI SPECIAL
- SKAI SPÉCIAL
- SKAI SPECIAL

COD. M0/527

- FODERINA SCHIENALE
- PLASTIC BACKREST COVER
- HOUSSE PROT. DOSSIER
- SCHUTZHÜLLE RÜCKENLEHNE

COD. JET MASSAGE

- JET MASSAGE 3 POSTI
- JET MASSAGE 3 SEATS
- MASSAGE JET 3 PLACES
- JET MASSAGE 3 PLATZ

COD. G3-N3

- SUPPLEMENTO PER 3 LAVABI NERI G3
- EXTRA CHARGE FOR 3 BLACK G3 BASINS
- SUPPLÉMENT POUR 3 CUVETTES G3 NOIRE
- AUFPREIS 3 SCHWARZEN BECKEN G3

COD. FIN. DIAMOND

- FINITURA CON BOTTONI EFFETTO DIAMANTE
- VERSION WITH BUTTONS "DIAMONDS" EFFECT
- BOUTONS EFFET "DIAMANTS"
- DIAMANT EFFET TASTEN

COD. 465

- SUPPLEMENTO PER 3 MISCELATORI TERMOSTATICI CON FORCELLA.
- PRICE SUPPLEMENT FOR 3 THERMOSTATIC WATER MIXER WITH DROP-STOP SYSTEM.
- SUPPLÉMENT POUR 3 MITIGEURS THERMOSTATIQUES AVEC SYSTÈME ANTI-GOUTTE.
- AUFPREIS FÜR 3 TERMOSTATISCHE MISCHBATTERIEN MIT "DROP-STOP" SYSTEM.

RIVA



COD. 991



H1

INSTALLAZIONE / INSTALLATION
INSTALLATION / INSTALLATION

TAPPEZZERIA / UPHOLSTERY
TAPISSERIE / POLSTER

70

120 - 151

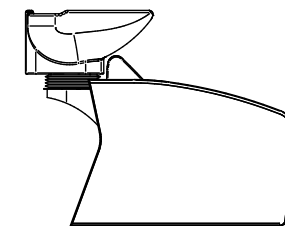
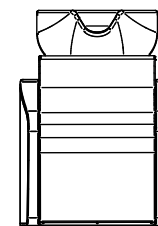

69

- VERSIONI
- MODELS
- VERSIONS
- VERSIONEN

- ACCESSORI
- ACCESSORIES
- ACCESSOIRES
- ZUBEHÖR



RIVA FIX

- FISSO CON VASCA H1 BIANCA, MISCELATORE CON FORCELLA.
- FIX WITH WHITE BASIN H1, DROP-STOP SYSTEM.
- FIX AVEC CUVETTE BLANCHE H1, MITIGEUR ANTI-GOUTTE.
- FEST MIT "H1" BECKEN, MISCHBATTERIE MIT DROP-STOP SYSTEM.

COD. 544



RIVA RELAX

- ALZAGAMBE ELETTRICO, VASCA H1 BIANCA, MISCEL. CON FORCELLA.
- ELECTRIC LEGREST, WHITE BASIN H1, DROP-STOP SYSTEM.
- REPOSE JAMBES EL., CUVETTE BLANCHE H1, MITIGEUR ANTI-GOUTTE.
- ELEKTRISCHE BEINAUFLAGE MIT H1 BECKEN, MISCHBATTERIE MIT DROP-STOP SYSTEM.

COD. 544P



RIVA SHIATSU AIR

- MASSAGGIO SHIATSU AIR SOLO SCHIENA, ALZAGAMBE ELETTRICO, VASCA H1 BIANCA, MISCELATORE CON FORCELLA.
- SHIATSU AIR MASSAGE BACKREST ONLY, ELECTRIC LEGREST, WHITE BASIN H1, DROP-STOP SYSTEM.
- SHIATSU AIR MASSAGE UNIQUEMENT SUR LE DOSSIER, REPOSE JAMBES, CUVETTE BLANCHE H1, MITIGEUR ANTI GOUTTE.
- SHIATSU AIR MASSAGE NUR AUF DER RÜCKENLEHNE, ELEKTRISCHE BEINAUFLAGE MIT H1 BECKEN, MISCHBATTERIE MIT DROP-STOP SYSTEM.

COD. 544S



RIVA JET MASSAGE

- MASSAGGIO JET, ALZAGAMBE EL., VASCA H1 BIANCA, MISCELATORE CON FORCELLA.
- JET MASSAGE, ELECTR. LEGREST, WHITE BASIN H1, DROP-STOP SYSTEM.
- JET MASSAGE, REP. JAMBES, COUV. BLANCHE H1, MITIGEUR ANTI-GOUTTE.
- JET MASSAGE, ELEKTRISCHE BEINAUFLAGE MIT H1 BECKEN, MISCHBATTERIE MIT DROP-STOP SYSTEM.

COD. 544M

COD. SPECIAL

- SKAI SPECIAL
- SKAI SPECIAL
- SKAI SPÉCIAL
- SKAI SPECIAL

COD. H3

- SUPPLÉM. LAVABO NERO H3
- EXTRA.CHARGE BLACK H3 BASIN
- SUPPLÉM. CUVETTE H3 EN NOIR
- AUFPREIS SCHWARZ BECKEN H3

COD. M0/537

- FODERINA SCHIENALE
- PLASTIC BACKREST COVER
- HOUSSE PROTECTION DOSSIER
- SCHUTZHÜLLE RÜCKENLEHNE

COD. 176

- CUSCINO RIALZO H.5 CM
- CHILDREN CUSHION H.5 CM
- COUSSIN ENFANT H.5 CM
- SITZUNG KISSEN H.5 CM

COD. SPECIAL

- SKAI SPECIAL PER CUSCINO SPECIALE
- SPECIAL VINYL FOR CUSHION
- SKAI SPÉCIAL COUSSIN
- SKAI SPECIAL SITZUNG KISSEN

COD. 991

- CARTER ALLACCIAM. IDRAULICO VERTICALE.
- COVER FOR VERTICAL HYDRAULIC CONNECTION.
- CACHE BRANCHEMENT. HYDRAULIC VERTICAL.
- HINTERER GEHÄUSE FÜR VERTIKAL INSTALLATION.

COSMO



H1



COD.991

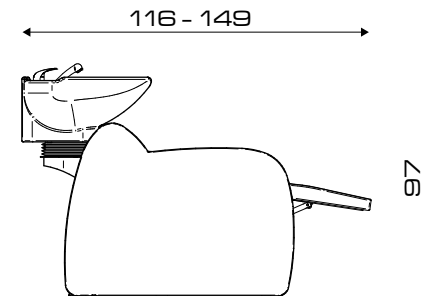
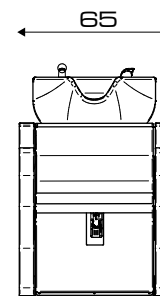

- VERSIONI
- MODELS
- VERSIONS
- VERSIONEN

- ACCESSORI
- ACCESSORIES
- ACCESSOIRES
- ZUBEHÖR



COSMO FIX

- FISSO CON VASCA H1 BIANCA, MISCELATORE CON FORCELLA.
- FIX WITH WHITE BASIN H1, DROP-STOP SYSTEM.
- FIX AVEC CUVETTE BLANCHE H1, MITIGEUR ANTI-GOUTTE.
- FEST MIT "H1" BECKEN, MISCHBATTERIE MIT DROP-STOP SYSTEM.

COD. 512



COSMO RELAX

- ALZAGAMBE ELETTRICO, VASCA H1 BIANCA, MISCEL. CON FORCELLA.
- ELECTRIC LEGREST, WHITE BASIN H1, DROP-STOP SYSTEM.
- REPOSE JAMBES EL., CUVETTE BLANCHE H1, MITIGEUR ANTI-GOUTTE.
- ELEKTRISCHE BEINAUFLAGE MIT H1 BECKEN, MISCHBATTERIE MIT DROP-STOP SYSTEM.

COD. 512P



COSMO SHIATSU AIR

- MASSAGGIO SHIATSU AIR SOLO SCHIENA, ALZAGAMBE ELETTRICO, VASCA H1 BIANCA, MISCELATORE CON FORCELLA.
- SHIATSU AIR MASSAGE BACKREST ONLY, ELECTRIC LEGREST, WHITE BASIN H1, DROP-STOP SYSTEM.
- SHIATSU AIR MASSAGE UNIQUEMENT SUR LE DOSSIER, REPOSE JAMBES, CUVETTE BLANCHE H1, MITIGEUR ANTI GOUTTE.
- SHIATSU AIR MASSAGE NUR AUF DER RÜCKENLEHNE, ELEKTRISCHE BEINAUFLAGE MIT H1 BECKEN, MISCHBATTERIE MIT DROP-STOP SYSTEM.

COD. 512S



COSMO JET MASSAGE

- MASSAGGIO JET, ALZAGAMBE EL., VASCA H1 BIANCA, MISCELATORE CON FORCELLA.
- JET MASSAGE, ELECTR. LEGREST, WHITE BASIN H1, DROP-STOP SYSTEM.
- JET MASSAGE, REP. JAMBES, CUVETTE BLANCHE H1, MITIGEUR ANTI-GOUTTE.
- JET MASSAGE, ELEKTRISCHE BEINAUFLAGE MIT H1 BECKEN, MISCHBATTERIE MIT DROP-STOP SYSTEM.

COD. 512M

COD. SPECIAL

- SKAI SPECIAL
- SKAI SPECIAL
- SKAI SPÉCIAL
- SKAI SPECIAL

COD. H3

- SUPPLEM. LAVABO NERO H3
- EX. CHARGE BLACK H3 BASIN
- SUPPLÉM. CUVETTE H3 EN NOIR
- AUFPREIS SCHWARZ BECKEN H3

COD. M0/537

- FODERINA SCHIENALE
- PLASTIC BACKREST COVER
- HOUSSE PROTECTION DOSSIER
- SCHUTZHÜLLE RÜCKENLEHNE

COD. 991

- CARTER ALLACCIAM. IDRAULICO VERTICALE.
- COVER FOR VERTICAL HYDRAULIC CONNECTION.
- CACHE BRANCHEMENT HYDRAULIC VERTICAL.
- HINTERER GEHÄUSE FÜR VERTIKAL INSTALLATION.

COD. 176

- CUSCINO RIALZO H.5 CM
- CHILDREN CUSHION H.5 CM
- COUSSIN ENFANT H.5 CM
- SITZUNG KISSEN H.5 CM

COD. SPECIAL

- SKAI SPECIAL PER CUSCINO SPECIALE
- SPECIAL VINYL FOR CUSHION
- SKAI SPÉCIAL COUSSIN
- SKAI SPECIAL SITZUNG KISSEN

BYRON



COD.991



H1

INSTALLAZIONE / INSTALLATION
INSTALLATION / INSTALLATION

TAPPEZZERIA / UPHOLSTERY
TAPISSERIE / POLSTER

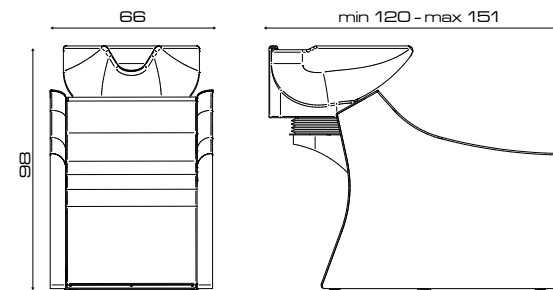

- VERSIONI
- MODELS
- VERSIONS
- VERSIONEN

- ACCESSORI
- ACCESSORIES
- ACCESSOIRES
- ZUBEHÖR



BYRON FIX

- FISSO CON VASCA H1 BIANCA, MISCELATORE CON FORCELLA.
- FIX WITH WHITE BASIN H1, DROP-STOP SYSTEM.
- FIX AVEC CUVETTE BLANCHE H1, MITIGEUR ANTI-GOUTTE.
- FEST MIT "H1" BECKEN, MISCHBATTERIE MIT DROP-STOP SYSTEM.

COD. 501



BYRON RELAX

- ALZAGAMBE ELETTRICO, VASCA H1 BIANCA, MISCELATORE CON FORCELLA.
- ELECTRIC LEGREST, WHITE BASIN H1, DROP-STOP SYSTEM.
- REPOSE JAMBES EL., CUVETTE BLANCHE H1, MITIGEUR ANTI-GOUTTE.
- ELEKTRISCHE BEINAUFLAGE MIT H1 BECKEN, MISCHBATTERIE MIT DROP-STOP SYSTEM.

COD. 501P



BYRON SHIATSU AIR

- MASSAGGIO SHIATSU AIR SOLO SCHIENA, ALZAGAMBE ELETTRICO, VASCA H1 BIANCA, MISCELATORE CON FORCELLA.
- SHIATSU AIR MASSAGE BACKREST ONLY, ELECTRIC LEGREST, WHITE BASIN H1, DROP-STOP SYSTEM.
- SHIATSU AIR MASSAGE UNIQUEMENT SUR LE DOSSIER, REPOSE JAMBES, CUVETTE BLANCHE H1, MITIGEUR ANTI GOUTTE.
- SHIATSU AIR MASSAGE NUR AUF DER RÜCKENLEHNE, ELEKTRISCHE BEINAUFLAGE MIT H1 BECKEN, MISCHBATTERIE MIT DROP-STOP SYSTEM.

COD. 501S



BYRON JET MASSAGE

- MASSAGGIO JET, ALZAGAMBE EL., VASCA H1 BIANCA, MISCELATORE CON FORCELLA.
- JET MASSAGE, ELECTR. LEGREST, WHITE BASIN H1, DROP-STOP SYSTEM.
- JET MASSAGE, REP. JAMBES, COUV. BLANCHE H1, MITIGEUR ANTI-GOUTTE.
- JET MASSAGE, ELEKTRISCHE BEINAUFLAGE MIT H1 BECKEN, MISCHBATTERIE MIT DROP-STOP SYSTEM.

COD. 501M

COD. SPECIAL

- SKAI SPECIAL
- SKAI SPECIAL
- SKAI SPÉCIAL
- SKAI SPECIAL

COD. H3

- SUPPLEM. LAVABO NERO H3
- EX. CHARGE BLACK H3 BASIN
- SUPPLÉM. CUVETTE H3 EN NOIR
- AUFPREIS SCHWARZ BECKEN H3

COD. M0/537

- FODERINA SCHIENALE
- PLASTIC BACKREST COVER
- HOUSSE PROTECTION DOSSIER
- SCHUTZHÜLLE RÜCKENLEHNE

COD. 176

- CUSCINO RIALZO H.5 CM
- CHILDREN CUSHION H.5 CM
- COUSSIN ENFANT H.5 CM
- SITZUNG KISSEN

COD. SPECIAL

- SKAI SPECIAL PER CUSCINO SPECIALE
- SPECIAL VINYL FOR CUSHION
- SKAI SPÉCIAL COUSSIN
- SKAI SPECIAL SITZUNG KISSEN

COD. 991

- CARTER ALLACCIAM. IDRAULICO VERTICALE.
- COVER FOR VERTICAL HYDRAULIC CONNECTION.
- CACHE BRANCHEMENT HYDRAULIC VERTICAL.
- HINTERER GEHÄUSE FÜR VERTIKAL INSTALLATION.

INSTALLAZIONE / INSTALLATION
INSTALLATION / INSTALLATION

TAPPEZZERIA / UPHOLSTERY
TAPISSERIE / POLSTER
COD. 528

TAPPEZZERIA / UPHOLSTERY
TAPISSERIE / POLSTER
COD. 528P/528M

SESTO SENSO PRO

- STRUTTURA DISPONIBILE IN ACCIAIO INOX O ALLUMINIO
- STRUCTURE AVAILABLE IN STAINLESS STEEL OR ALUMINIUM
- STRUCTURE DISPONIBLE EN ACIER INOX OU ALUMINIUM
- STRUKTUR AUS EDELSTAHL ODER ALLUMINIUM ERHÄLTICH

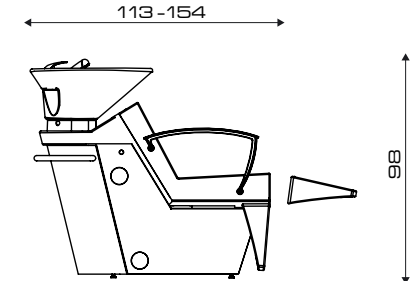
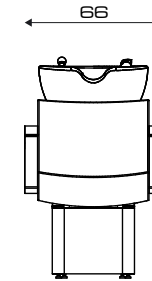

- VERSIONI
- MODELS
- VERSIONS
- VERSIONEN

- ACCESSORI
- ACCESSORIES
- ACCESSOIRES
- ZUBEHÖR



SESTO SENSO PRO FIX - ALLUMINIO

- FISSO CON VASCA G1 BIANCA, MISCELATORE CON FORC ELLA.
- FIX WITH WHITE BASIN G1, DROP-STOP SYSTEM.
- FIX AVEC CUVETTE BLANCHE G1, MITIGEUR ANTI-GOUTTE.
- FEST MIT G1 BECKEN, MISCHBATTERIE MIT DROP-STOP SYSTEM.

COD. 528



SESTO SENSO PRO RELAX - ALLUMINIO

- ALZAGAMBE ELETTRICO, VASCA G1 BIANCA, MISCEL. CON FORCELLA.
- ELECTRIC LEGREST, WHITE BASIN G1, DROP-STOP SYSTEM.
- REPOSE JAMBES EL., CUVETTE BLANCHE G, MITIGEUR ANTI-GOUTTE.
- ELEKTRISCHE BEINAUFLAGE MIT G1 BECKEN, MISCHBATTERIE MIT DROP-STOP SYSTEM.

COD. 528P



SESTO SENSO PRO SHIATZU MASSAGE CONTOUR - ALLUMINIO

- MASSAGGIO SHIATZU CONTOUR, ALZAGAMBE ELETTRICO, VASCA G1 BIANCA, MISCELATORE CON FORCELLA.
- SHIATZU CONTOUR MASSAGE, ELECTRIC LEGREST, WHITE BASIN G1, DROP-STOP SYSTEM.
- SHIATZU CONTOUR MASSAGE, REPOSE-JAMBES, CUVETTE BLANCHE G1", MITIGEUR ANTI-GOUTTE.
- SHIATZU CONTOUR MASSAGE, ELEKTRISCHE BEINAUFLAGE MIT G1 BECKEN, MISCHBATTERIE MIT DROP-STOP SYSTEM.

COD. 528M

COD. INOX

- SUPPLEMENTO STRUTTURA INOX
- EXTRA CHARGE FOR ST. STEEL STRUCT.
- SUPPLÉMENT STRUCTURE INOX
- ZUSCHLAG FÜR EDELSTAHL STRUKTUR

COD. 468

- PEDALIERA (SOLO PER MASSAGGIO SHIATSU)
- FOOT CONTROL (SHIATSU MASSAGE ONLY)
- COMMANDE AU PIED (POUR MASS. SHIATSU).
- FUSSPEDAL (NUR FÜR SHIATSU).

COD. SPECIAL - COD. 528

- SKAI SPECIAL PER 528
- SKAI SPECIAL FOR 528
- SKAI SPECIAL POUR 528P/528M
- SKAI SPECIAL FÜR 528

COD. M0/504

- FODERINA SCHIENALE
- PLASTIC BACKREST COVER
- HOUSSE PROTECTION DOSSIER
- SCHUTZHÜLLE RÜCKENLEHNE

COD. G3

- SUPPLEM. LAVABO NERO G3
- EXTRA CHARGE BLACK G3 BASIN
- SUPPLÉM. CUVETTE G3 EN NOIR
- AUFPREIS SCHWARZ BECKEN G3

COD. 5041.1

- MOBILETTO INTERMEDIO INOX
- INTERMEDIATE CABINET ST. STEEL
- MEUBLE INTERCALAIRE INOX
- ZWISCHENMÖBEL AUS EDELSTAHL

COD. SPECIAL - COD. 528P/528M

- SKAI SPECIAL PER 528P/528M
- SKAI SPECIAL FOR 528P/528M
- SKAI SPECIAL POUR 528P/528M
- SKAI SPECIAL FÜR 528P/528M

MR. PAUL WASH

- COLORI STRUTTURA
- STRUCTURE COLORS
- COULEURS DE LA STRUCTURE
- FARBEN STRUKTUR



- ARGENTO
- SILVER
- ARGENT
- SILBER



- NERO
- BLACK
- NOIR
- SCHWARZ



COD. BRACC.

- BRACCIOLI IMBOTTITI
- PADDED ARMREST
- ACCOUDOIRS REMBOURRÉS EN SKAI
- GEPOLSTERTE ARMLEHNEN

- VERSIONI
- MODELS
- VERSIONS
- VERSIONEN



COD. 466

COD. 410

- ACCESSORI
- ACCESSORIES
- ACCESSOIRES
- ZUBEHÖR

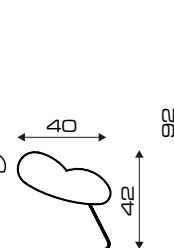
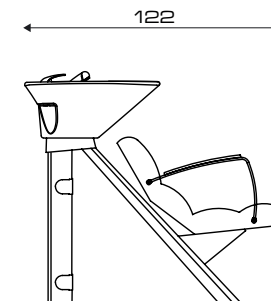
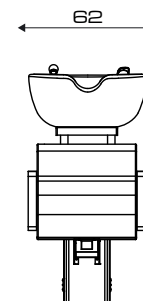

COD. 401



G1



MR. PAUL WASH

- FISSO, STRUTTURA ACCIAIO, FIANCATE NERE O SILVER, VASCA G1 BIANCA, MISCELATORE STANDARD.
- FIX, ST. STEEL STRUCTURE, SILVER OR BLACK SIDES, WHITE BASIN G1, STANDARD WATER MIXER.
- FIX, STRUCTURE ACIER, CÔTÉS NOIRS OU GRIS, CUVETTE BLANCHE G1, MITIGEUR STANDARD.
- FEST, STAHL-STRUKTUR, SEITEN SCHWARZ ODER SILBER, BECKEN G1 WEISS, STANDARD MISCHBATTERIE.

COD. 410

COD. SPECIAL

- SKAI SPECIAL
- SKAI SPÉCIAL
- SKAI SPÉCIAL
- SKAI SPECIAL

COD. 466

- POGGIAGAMBE MR. PAUL
- FOOTREST MR. PAUL
- REPOSE-JAMBES MR. PAUL
- BEINAUFLAGE MR. PAUL

COD. SPECIAL

- SKAI SPECIAL PER POGGIAGAMBE MR. PAUL WASH
- SKAI SPECIAL FOOTREST MR. PAUL WASH
- SKAI SPECIAL REPOSE-JAMBES MR. PAUL WASH
- AUFPREIS FÜR SONDER-BEZUG FÜR BEINAUFLAGE MR. PAUL WASH

COD. BRACC.

- BRACCIOLI IMBOTTITI
- PADDED ARMRESTS
- ACCOUD. REMBOURRÉS EN SKAI
- GEPOLSTERTE ARMLEHNEN

COD. G3

- SUPPLEMENTO LAVABO NERO G3
- EXTRA CHARGE BLACK G3 BASIN
- SUPPLÉM. CUVETTE G3 EN NOIR
- AUFPREIS SCHWARZ BECKEN G3

COD. M0/96

- FODERINA SCHIENALE
- PLASTIC BACKREST COVER
- HOUSSE PROTECTION DOSSIER
- SCHUTZHÜLLE RÜCKENLEHNE

COD. 401

- MOBILE INTERMEDIO
- INTERMEDIATE CABINET
- MEUBLE INTERCALAIRE
- ZWISCHENMÖBEL

MR. PAUL WASH RELAX

- ALZAGAMBE MANUALE
- MANUAL LEG REST
- REPOSE-PIEDS MANUEL
- MANUELLE BEINAUFLAGE

- COLORI STRUTTURA
- STRUCTURE COLORS
- COULEURS DE LA STRUCTURE
- FARBEN STRUKTUR



- ARGENTO
- SILVER
- ARGENT
- SILBER
- NERO
- BLACK
- NOIR
- SCHWARZ



COD. BRACC.

- BRACCIOLI IMBOTTITI
- PADDED ARMREST
- ACCOUDOIRS REMBOURRÉS
- GEPOLSTERTE ARMLEHNEN

- VERSIONI
- MODELS
- VERSIONS
- VERSIONEN



MR. PAUL WASH RELAX

- ALZAGAMBE MANUALE, STRUTTURA ACCIAIO, FIANCATE NERE O SILVER, VASCA G1 BIANCA, MISCELATORE STANDARD.
- MANUAL LEGREST, ST. STEEL STRUCTURE, SILVER OR BLACK SIDES, WHITE BASIN G1, STANDARD WATER MIXER.
- LÈVE-JAMBES MANUEL, STRUCTURE ACIER, CÔTÉS NOIRS OU GRIS, CU-VETTE BLANCHE G1, MITIGEUR STANDARD.
- MANUELL BEINAUFLAGE, STAHL-STRUKTUR, SEITEN SCHWARZ ODER SILBER, BECKEN G1 WEISS, STANDARD MISCHBATTERIE.

COD. 410P



- ACCESSORI
- ACCESSORIES
- ACCESSOIRES
- ZUBEHÖR



COD. 401

COD. SPECIAL

- SKAI SPECIAL
- SKAI SPECIAL
- SKAI SPÉCIAL
- SKAI SPECIAL

COD. M0/96

- FODERINA SCHIENALE
- PLASTIC BACKREST COVER
- HOUSSE PROTECTION DOSSIER
- SCHUTZHÜLLE RÜCKENLEHNE

COD. 401

- MOBILE INTERMEDIO
- INTERMEDIATE CABINET
- MEUBLE INTERCALAIRE
- ZWISCHENMÖBEL

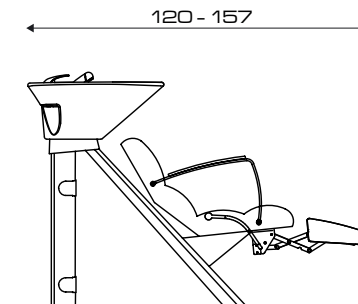
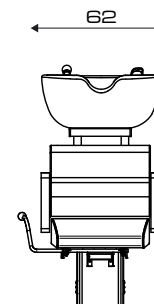

G1

COD. BRACC.

- BRACCIOLI IMBOTTITI
- PADDED ARMRESTS
- ACCOUD. REMBOURRÉS EN SKAI
- GEPOLSTERTE ARMLEHNEN

COD. G3

- SUPPLEMENTO LAVABO NERO G3
- EXTRA CHARGE BLACK G3 BASIN
- SUPPLÉM. CUVETTE G3 EN NOIR
- AUFPREIS SCHWARZ BECKEN G3

KELLY WASH

- COLORI STRUTTURA
- STRUCTURE COLORS
- COULEURS DE LA STRUCTURE
- FARBEN STRUKTUR



- ARGENTO
- SILVER
- ARGENT
- SILBER



- NERO
- BLACK
- NOIR
- SCHWARZ



INSTALLAZIONE / INSTALLATION
INSTALLATION / INSTALLATION

TAPPEZZERIA / UPHOLSTERY
TAPISSERIE / POLSTER

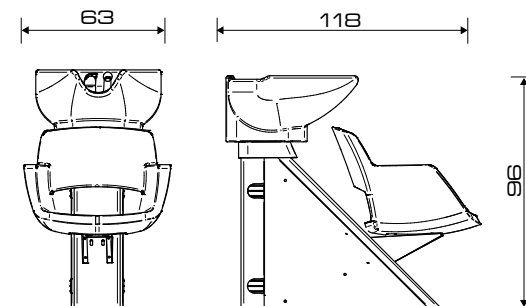

COD. 401



G1

- VERSIONI
- MODELS
- VERSIONS
- VERSIONEN

- ACCESSORI
- ACCESSORIES
- ACCESSOIRES
- ZUBEHÖR



KELLY WASH

- FISSO, STRUTTURA ACCIAIO, FIANCATE NERE O SILVER, VASCA G1 BIANCA, MISCELATORE STANDARD.
- FIX, ST. STEEL STRUCTURE, SILVER OR BLACK SIDES, WHITE BASIN G1, STANDARD WATER MIXER.
- FIX, STRUCTURE ACIER, CÔTÉS NOIRS OU GRIS, CUVETTE BLANCHE G1, MITIGEUR STANDARD.
- FEST, STAHL-STRUKTUR, SEITEN SCHWARZ ODER SILBER, BECKEN G1 WEISS, STANDARD MISCHBATTERIE.

COD. 20L

COD. SPECIAL

- SKAI SPECIAL
- SKAI SPECIAL
- SKAI SPECIAL
- SKAI SPECIAL

COD. 401

- MOBILE INTERMEDIO
- INTERMEDIATE CABINET
- MEUBLE INTERCALAIRE
- ZWISCHENMÖBEL

COD. M0/20

- FODERINA SCHIENALE
- PLASTIC BACKREST COVER
- HOUSSE PROTECTION DOSSIER
- SCHUTZHÜLLE RÜCKENLEHNE

COD. G3

- SUPPL. LAVABO NERO G3.
- EXTRA CHARGE BLACK G3 BASIN.
- SUPPLÉMENT CUVETTE G3 EN NOIR.
- AUFPREIS SCHWARZ BECKEN G3

WELLY



COD. BRACC.

- BRACCIOLI IMBOTTITI
- PADDED ARMRESTS
- ACCOUDOIRS REMBOURRÉS
- GEPOLSTERTE ARMLEHNEN



COD. 530.70



COD. 530.70 + OPTIMA

- EMBOSSING NON DISPONIBILE
- EMBOSSING NOT AVAILABLE
- EMBOSSING PAS DISPONIBLE
- EMBOSSING NICHT VERFÜGBAR

INSTALLAZIONE / INSTALLATION
INSTALLATION / INSTALLATION

TAPPEZZERIA / UPHOLSTERY
TAPISSERIE / POLSTER
COD. 530.70

TAPPEZZERIA / UPHOLSTERY
TAPISSERIE / POLSTER
COD. 530.70+OPTIMA

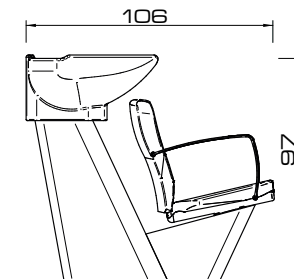
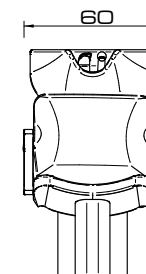

H1

- VERSIONI
- MODELS
- VERSIONS
- VERSIONEN

- ACCESSORI
- ACCESSORIES
- ACCESSOIRES
- ZUBEHÖR



WELLY

- FISSO, CON VASCA H1 BIANCA, MISCELATORE STANDARD.
- FIX, WITH WHITE BASIN H1, STANDARD WATER MIXER.
- FIX, AVEC CUVETTE BLANCHE H1, MITIGEUR STANDARD.
- FEST, MIT WASCHBECKEN G1, STANDARD MISCHBATTERIE.

COD. 530.70

COD. SPECIAL

- SKAI SPECIAL.
- SKAI SPECIAL
- SKAI SPÉCIAL
- SKAI SPECIAL

COD. M0/70

- FODERINA SCHIENALE
- PLASTIC BACKREST COVER
- HOUSSE PROTECTION DOSSIER
- SCHUTZHÜLLE RÜCKENLEHNE

COD. BRACC.

- BRACCIOLI IMBOTTITI
- PADDED ARMRESTS
- ACCOUDOIRS REMBOURRÉS
- GEPOLSTERTE ARMLEHNEN

COD. H3

- SUPPL. LAVABO NERO H3
- EXT. CHARGE BLACK H3 BASIN
- SUPPL. CUVETTE H3 EN NOIR
- AUFPREIS SCHWARZ BECKEN H3

COD. OPTIMA

- TRAPUNTATURA CON CUCITURA A ROMBI
- CROSS STITCHING FINISHING
- EFFET POINT DE CROIX
- GESTEPPUNG MIT RAUTENFÖRMIGEN NÄHTEN



- BIANCO
- WHITE
- BLANC
- WEISS

- ANTRACITE
- ANTHRACITE
- ANTHRACIT

- NERO
- BLACK
- NOIR
- SCHWARZ

PURITY

- COLORE STANDARD COLONNA
- COLUMN STANDARD COLOR
- COULEUR STANDARD COLONNE
- KOLUMNE STANDARD FARBEN



[PAG.215](#)



COD. 513 + COD. FIN + COD.N3

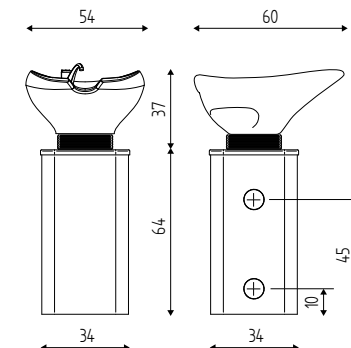

COD. 513

- VERSIONI
- MODELS
- VERSIONS
- VERSIONEN



COD. 513

- COLONNA LAVAGGIO VERNICIATA NERA, VASCA N1 BIANCA, MISCELATORE CON FORCELLA
- WASHING COLUMN BLACK PAINTED, WHITE BASIN N1, DROP-STOP SYSTEM.
- COLONNE LAVAGE PEINT EN NOIR, CUVETTE BLANCHE N1, MITIGEUR ANTI-GOUTTE.
- FREIGESTELLT WASCH-SAULE SCHWARZ LACKIERT, WEISS "N1" BECKEN, MISCHBATTERIE MIT DROP-STOP SYSTEM.

- ACCESSORI
- ACCESSORIES
- ACCESSOIRES
- ZUBEHÖR

COD. FIN

- SUPPLEMENTO ALTRI COLORI COLONNA
- EXTRA CHARGE FOR OTHER COLUMN COLOURS
- SUPPLEMENT POUR AUTRES COULEURS DE LA COLONNE.
- ZUSCHLAG FÜR ANDERE SÄULENFARBEN

COD. 465

- SUPPLEM. MISCEL. TERMOSTATICO CON FORCELLA.
- EXTRA CHARGE THERMOST. WATER MIXER WITH DROP-STOP SYSTEM.
- SUPPLEMENT MITIGEUR THERMOSTAT. ET SYSTÈME ANTI-GOUTTE
- AUFPREIS FÜR TERMOSTAT. MISCHBATTERIE MIT DROP-STOP SYSTEM.

COD. N3

- SUPPL.LAVABO NERO N3.
- EXTRA CHARGE BLACK N3 BASIN.
- SUPPLÈMENT CUVETTE NOIRE N3
- AUFPREIS SCHWARZ BECKEN N3

WASHMASTER

INSTALLAZIONE / INSTALLATION
INSTALLATION / INSTALLATION



COD. 2000



COD. 2000.3

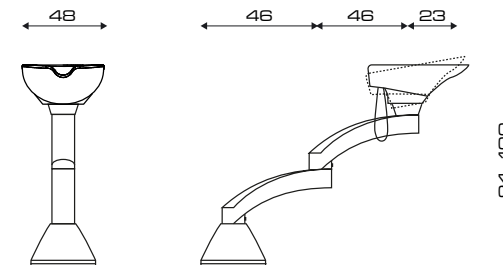

- VERSIONI
- MODELS
- VERSIONS
- VERSIONEN

- VERSIONI
- MODELS
- VERSIONS
- VERSIONEN



COD. 2000

- LAVAGGIO A BRACCIO CON LAVABO BIANCO.
- ARM-TYPE BACKWASH UNIT WITH WHITE BASIN.
- BAC DE LAVAGE À BRAS AVEC CUVETTE BLANCHE.
- SCHWENK- UND KIPPBARE WASCHANLAGE MIT WEISS BECKEN



COD. 2000.3

- LAVAGGIO A BRACCIO CON LAVABO NERO.
- ARM-TYPE BACKWASH UNIT, BLACK BASIN.
- BAC DE LAVAGE À BRAS AVEC CUVETTE NOIRE.
- SCHWENK- UND KIPPBARE WASCHANLAGE MIT SCHWARZ BECKEN.

TAU

TAPPEZZERIA / UPHOLSTERY
TAPISSERIE / POLSTER

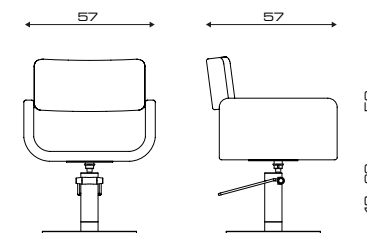

- VERSIONI
- MODELS
- VERSIONS
- VERSIONEN

- GIREVOLE
- SWIVEL
- TOURNANT
- DREHBAR

- ACCESSORI
- ACCESSORIES
- ACCESSOIRES
- ZUBEHÖR



COD. 62L.16L

COD. SPECIAL

- SKAI SPECIAL
- SKAI SPECIAL
- SKAI SPÉCIAL
- SKAI SPECIAL



COD. 62L.55

ACCESSORI PER TUTTI I LAVAGGI - ACCESSORIES FOR EVERY BACKWASH UNIT ACCESSOIRES POUR TOUS LES BACS - ZUBEHÖR FÜR ALLE WASCHANLAGEN



COD. 411

- GIROCOLLO SILICONE NERO
- BLACK SILICONE NECK PROTECTOR
- PROTÈGE-COU EN SILICONE NOIRE
- SCHWARZE SILIKONNACKENKISSEN

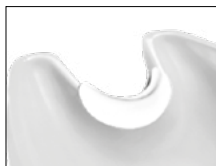

COD. 412

- GIROCOLLO SILICONE BIANCO
- WHITE SILICONE NECK PROTECTOR
- PROTÈGE-COU EN SILICONE BLANCHE
- WEISSE SILIKONNACKENKISSEN



COD. 523

COD. 524

COD. 523 - COD. 524

- VASCHETTA DI SERVIZIO PER LAVAGGI WEN E PASHÀ
- LINK BOWL FOR WASHUNIT WEN AND PASHÀ
- PETITE CUVE DE SERVICE DISPONIBLE COMME ACCESSOIRE POUR BACS WEN ET PASHÀ
- SERVICETANK LIEFERBAR ALS OPTION FÜR WEN UND PASHÀ



COD. 532

COD. 533

COD. 532 - COD. 533

- VASCHETTA DI SERVIZIO PER LAVAGGI ZONE WASH
- LINK BOWL FOR WASHUNIT ZONE WASH
- PETITE CUVE DE SERVICE DISPONIBLE COMME ACCESSOIRE POUR BACS ZONE WASH
- SERVICETANK LIEFERBAR ALS OPTION FÜR ZONE WASH



COD. 532.1

COD. 533.1

COD. 532.1 - COD. 533.1

- VASCHETTA DI SERVIZIO PER LAVAGGI CAMACHO E LONDRA
- LINK BOWL FOR WASHUNIT CAMACHO AND LONDRA
- PETITE CUVE DE SERVICE DISPONIBLE COMME ACCESSOIRE POUR BACS CAMACHO ET LONDRA
- SERVICETANK LIEFERBAR ALS OPTION FÜR CAMACHO UND LONDRA



COD. 471

- NR. 1 FLANGIA (IN 2 PEZZI) PER SCARICO ACQUA LATERALE PER I LAVAGGI:
- NR. 1 FLANGE (IN 2 PIECES) FOR SIDE WATER DRAINAGE ON WASH UNITS:
- NO. 1 BRIDE (EN DEUX PIÈCES) POUR L'ÉVACUATION LATÉRALE DE L'EAU POUR BACS:
- NO. 1 FLANSCH (IN ZWEI STÜCKEN) FÜR SEITLICHEN WASSERABLAUF FÜR WASHENLAGEN:

- CAMACHO
- LONDRA
- TRESOR
- ZONE



COD. 473

- NR. 1 FLANGIA (IN 2 PEZZI) PER SCARICO ACQUA LATERALE PER I LAVAGGI:
- NR. 1 FLANGE (IN 2 PIECES) FOR SIDE WATER DRAINAGE ON WASH UNITS:
- NO. 1 BRIDE (EN DEUX PIÈCES) POUR L'ÉVACUATION LATÉRALE DE L'EAU POUR BACS:
- NO. 1 FLANSCH (IN ZWEI STÜCKEN) FÜR SEITLICHEN WASSERABLAUF FÜR WASHENLAGEN:

- FABLE
- BYRON
- PASHÀ
- RIVA
- WEN
- COSMO
- NUBI WASH
- SKYLINE



COD. 415

- GIROCOLLO IN GEL RIVESTITO
- UPHOLSTERED NECK PROTECTION IN GEL
- PROTÈGE-COU EN GEL TAPISSÉ
- BESCHICHTETE GELNACKENKISSEN



COD. 414

- GIROCOLLO IN GEL ECO
- NECK PROTECTION IN GEL
- PROTÈGE-COU EN GEL
- ECO GELNACKENKISSEN



COD. 459

- SUPPLEMENTO MISCELATORE **MINIMAL** CON FORCELLA
- PRICE SUPPLEMENT FOR DROP-STOP **MINIMAL** WATER MIXER
- SUPPLEMENT POUR MITIGEUR **MINIMAL** AVEC SYSTÈME ANTIGOUTTE
- AUFPREIS FÜR MISCHBATTERIE **MINIMAL** MIT "DROP-STOP" SYSTEM.



COD. 459 GOLD

- SUPPLEMENTO MISCELATORE **MINIMAL** CON FORCELLA COLOR ORO.
- PRICE SUPPLEMENT FOR DROP-STOP **MINIMAL** WATER MIXER GOLD COLOR.
- SUPPLEMENT DE PRIX POUR MITIGEUR **MINIMAL** ANTIGOUTTE COULEUR OR.
- AUFPREIS FÜR MISCHBATTERIE **MINIMAL** MIT DROP-STOP SYSTEM FARBE GOLD



COD. 465

- SUPPLEMENTO MISCELATORE TERMOSTATICO CON FORCELLA
- PRICE SUPPLEMENT THERMOSTATIC WATER MIXER WITH DROP-STOP SYSTEM.
- SUPPLEMENT MITIGEUR THERMOSTATIQUE AVEC SYSTÈME ANTI-GOUTTE
- AUFPREIS FÜR TERMOSTATISCHE MISCHBATTERIE MIT DROP-STOP SYSTEM



COD. 938

- CASCATA COMPLETA DI DIFFUSORE E DOCCETTA NERA.
- WATERFALL COMPLETE WITH DIFFUSER AND BLACK HAND SHOWER.
- CASCADE COMPLÈTE AVEC DIFFUSEUR ET DOUCHETTE NOIRE.
- WASSERFALL KOMPLETT MIT DIFFUSOR UND SCHWARZER HANDBRAUSE.



COD. 423

- DOCCETTA ERGONOMICA "PERFORMANCE" IN SILICONE NERO CON TUBO FLESSIBILE NERO 57 CM - SOLO PER MISCELATORE CON FORCELLA.
- ERGONOMIC BLACK SILICONE HAND SHOWER "PERFORMANCE" WITH 57 CM BLACK HOSE INCLUDED - ONLY FOR DROP-STOP SYSTEM WATER MIXER.
- DOUCHETTE ERGONOMIQUE "PERFORMANCE" EN SILICONE NOIR AVEC TUYAU NOIR 57 CM - UNIQUEMENT POUR LE MITIGEUR ANTI-GOUTTE.
- ERGONOMISCHE SCHWARZE SILIKONHANDBRAUSE "PERFORMANCE" MIT SCHWARZEM SCHLAUCH 57 CM - NUR FÜR MISCHBATTERIE MIT DROP-STOP SYSTEM.

ACCESSORI PER TUTTI I LAVAGGI - ACCESSORIES FOR EVERY BACKWASH UNIT ACCESSOIRES POUR TOUS LES BACS - ZUBEHÖR FÜR ALLE WASCHANLAGEN

COD. 962



- CUSCINO SPECIALE (INDICARE MODELLO POLTRONA E ALTEZZA)
- SPECIAL BOOSTER SEAT (SPECIFY CHAIR MODEL AND HEIGHT)
- COUSSIN SPECIAL (SPECIFIER MOD. DU BAC ET HAUTEUR)
- SPEZIELLES SITZKISSEN (STUHL MODELL UND HÖHE ANZEIGEN)

COD. SPECIAL

- SKAI SPECIAL CUSCINO COD. 962
- SKAI SPECIAL FOR CUSHION COD. 962
- SKAI SPÉCIAL COUSSIN COD. 962
- SKAI SPECIAL FÜR KISSEN COD. 962

COD. 472



- PEDALIERA (SOLO PER MODELLI JET MASSAGE)
- JET FOOT CONTROL (AVAILABLE ONLY FOR JET VERSION)
- COMMANDE AU PIED (SEULEMENT POUR MOD. JET MASSAGE)
- FUSSPEDAL (NUR FÜR WASCHANLAGEN MIT JET MASSAGE)

COD. 470



- PEDALIERA UP/DOWN (SOLO PER MODELLI CON ALZAGAMBE ELETTRICO)
- UP/DOWN FOOT CONTROL (AVAILABLE ONLY FOR RELAX VERSION)
- COMMANDE AU PIED UP/DOWN (POUR MOD. RELAX)
- FUSSPEDAL UP/DOWN (NUR FÜR WASCHANLAGEN MIT ELEKTRISCHE BEINAUFLAGE)

COD. 940/B - COD. 940/G - COD. 940/N

- CARTER GRIGIO 30 CM DISPONIBILE NEI COLORI ANTRACITE BIANCO E NERO (SOLO PER ALLACCIAMENTO A PARETE)
- STEEL CARTER 30 CM, AVAILABLE IN DARK GRAY, WHITE AND BLACK (ONLY FOR WALL CONNECTIONS).
- CARTER 30 CM DISPONIBLE EN GRIS FONCÉ, BLANC ET NOIR (POUR FIXATION MURALE).
- ZWISCHENMÖBEL 30 CM VERFÜGBAR IN ANTHRACITEN WEISS UND SCHWARZ FARBE (NUR FÜR WANDANSCHLUSS).

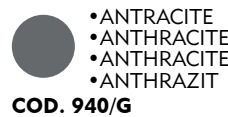
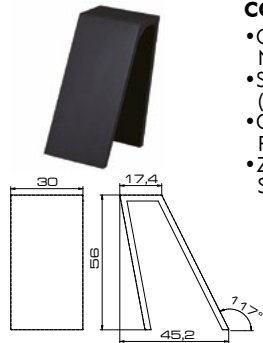

COD. 941/B - COD. 941/G - COD. 941/N

- CARTER GRIGIO 44 CM DISPONIBILE NEI COLORI ANTRACITE BIANCO E NERO (PER ALLACCIAMENTO A PARETE O INTERMEDIO TRA I LAVAGGI).
- STEEL CARTER 44 CM, AVAILABLE IN DARK GRAY, WHITE AND BLACK (TO LATERAL CONNECTION OR BETWEEN THE WASH UNITS).
- CARTER 44 CM DISPONIBLE EN GRIS FONCÉ, BLANC ET NOIR (POUR FIXATION MURAL OU INTERCALAIRE BAC DE LAVAGES).
- ZWISCHENMÖBEL 44 CM VERFÜGBAR IN ANTHRACITEN WEISSEN UND SCHWARZEN FARBEN (FÜR WANDANSCHLUSS ODER ALS ZWISCHENMÖBEL).

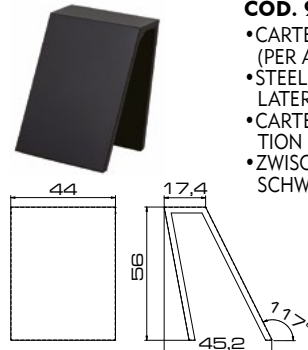

COD. 933



- KIT PULSANTIERA WIRELESS A 2 FUNZIONI! (PER LAVAGGI CON ALZAGAMBE ELETTRICO - ESCLUSO WEN LIFT E SESTO SENSO)
- 2 FUNCTION WIRELESS REMOTE CONTROL KIT (FOR WASH UNITS WITH ELECTRICAL LEGREST - EXCLUDING WEN LIFT AND SESTO SENSO).
- KIT TÉLÉCOMMANDE SANS FIL À 2 FONCTIONS (POUR BAC AVEC REPOSE-JAMBES ELECTRIQUE - À L'EXCLUSION DU WEN LIFT ET DU SESTO SENSO).
- KABELLOSE FERNBEDIENUNG MIT 2 FUNKTIONEN (NUR FÜR WASCHANLAGEN MIT ELEKTRISCHE BEINAUFLAGE - AUSGENOMMEN DAS MODELL WEN LIFT UND SESTO SENSO).

COD. 934



- KIT PULSANTIERA WIRELESS A 3 FUNZIONI! (PER LAVAGGI CON JET MASSAGE - ESCLUSO WEN LIFT E SESTO SENSO).
- 3 FUNCTION WIRELESS REMOTE CONTROL KIT (FOR WASH UNITS WITH JET MASSAGE - EXCLUDING WEN LIFT AND SESTO SENSO).
- KIT TÉLÉCOMMANDE SANS FIL À 3 FONCTIONS (POUR BAC AVEC JET MASSAGE - À L'EXCLUSION DU WEN LIFT ET DU SESTO SENSO).
- KABELLOSE FERNBEDIENUNG MIT 3 FUNKTIONEN (NUR FÜR WASCHANLAGEN MIT JET MASSAGE - AUSGENOMMEN DAS MODELL WEN LIFT UND SESTO SENSO).

COD. M0/400G



- FODERINA PVC PROTEZIONE ALZAGAMBE PER LAVAGGI :
- PVC LEGREST PROTECTION FOR WASH UNITS:
- HOUSSE DE PROTECTION EN PVC POUR REPOSE-PIEDS POUR BACS:
- SCHUTZ DER BEINSTÜTZEN AUS PVC FÜR WASHENLAGE:

- CAMACHO FIRST
- LONDRA FIRST
- TRESOR FIRST
- WEN FIRST

COD. M0/537.LIFT



- FODERINA PVC PROTEZIONE ALZAGAMBE PER LAVAGGI :
- PVC LEGREST PROTECTION FOR WASH UNITS:
- HOUSSE DE PROTECTION EN PVC POUR REPOSE-PIEDS POUR BACS:
- SCHUTZ DER BEINSTÜTZEN AUS PVC FÜR WASHENLAGE:

- WEN LIFT

COD. M0/537G



- FODERINA PVC PROTEZIONE ALZAGAMBE PER LAVAGGI :
- PVC LEGREST PROTECTION FOR WASH UNITS:
- HOUSSE DE PROTECTION EN PVC POUR REPOSE-PIEDS DES BACS:
- SCHUTZ DER BEINSTÜTZEN AUS PVC FÜR WASHENLAGE:

- BYRON
- RIVA
- COSMO
- WEN PRO
- ZONE PRO
- TRESOR MODULO

COD. M0/554.2



- FODERINA PVC PROTEZIONE ALZAGAMBE PER LAVAGGI :
- PVC LEGREST PROTECTION FOR WASH UNITS:
- HOUSSE DE PROTECTION EN PVC POUR REPOSE-PIEDS DES BACS:
- SCHUTZ DER BEINSTÜTZEN AUS PVC FÜR WASHENLAGE:

- NUBI WASH

CLICHE' EMBOSSEING



- REALIZZAZIONE CLICHÉ PER EMBOSSEING PERSONALIZZATO.
- PERSONALIZED CLICHE FOR EMBOSSEING.
- REALISATION CLICHÉ POUR EMBOSSEING PERSONALISÉ.
- KLISCHEE REALISIERUNG FÜR PERSONALISIERTE EMBOSSEING.

- STAMPA EMBOSSEING SINGOLA.
- EMBOSSEING PRINTING.
- IMPRESSION EMBOSSEING.
- EINZELN EMBOSSEING AUSDRUCK.

RETRO LAVAGGI
LABORATORIES
LABORATOIRES
LABOR





R-MODE



PAG.212



COD. 882.B+885I



COD. 3x882.B+3x885



COD. 3x882.B+3x885+3xFIN

INSTALLAZIONE / INSTALLATION
INSTALLATION / INSTALLATION

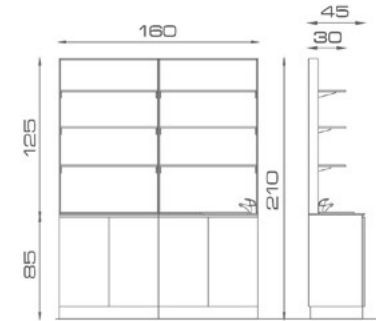

• PRODOTTI - PRODUCTS - PRODUITS - PRODUKTE

• ACCESSORI - ACCESSORIES - ACCESSOIRES - ZUBEHÖR

COD. 882.B



- MOBILE BASE CM.80 - 2 ANTE METACRI-LATO BIANCO LUCIDO.
- FLOOR CABINET CM 80 - 2 GLOSS WHI-TE METACHRYLATE DOORS.
- MEUBLE AU SOL CM. 80 - 2 PORTES EN MÉTHACRYLATE BLANC POLI.
- SERVICE SCHRANK CM 80 - 2 TÜREN AUS WEISS GLÄNZEND METHACRYLAT.

COD. 883.B



- MOBILE BASE CM.80 - 2 ANTE METACRI-LATO BIANCO LUCIDO, LAVABO INOX E MIXER.
- FLOOR CABINET CM 80 - 2 GLOSS WHI-TE METACHRYLATE DOORS - STEEL BA-SIN + MIXER TAP
- MEUBLE AU SOL CM 80 - 2 PORTES METHACRYL. BLANC POLI-LAVABO INOX ET MITIGEUR.
- SERVICE SCHRANK CM 80 - 2 TÜREN AUS WEISS GLÄNZEND METHACRYLAT, BECKEN AUS EDELSTAHL UND MIXER

COD. 885



- ESPOSITORE EXPO-LIGHT CM 80X125, STRUTTURA IN ALLUMINIO ANODIZZATO, 3 PIANETTI IN CRISTALLO, RETROILLUMINAZIONE A LED.
- EXPO-LIGHT WALL SHELVING UNIT CM. 80X125, ANODIZED ALUMI-NIUM STRUCTURE, 3 ADJUSTABLE GLASS SHELVES, LED BACKLIGHTING.
- PRÉSENTOIR EXPO-LIGHT CM. 80X125, STRUCTURE ALUMINIUM ANO-DISÉ, 3 TABLETTES RÉGLABLES EN CRISTAL, RÉTRO-ÉCLAIRAGE LED.
- VERKAUFSREGAL, EXPO-LIGHT CM 80X125 ALU STRUKTUR, KRISTALL FLÄCHER UND RÜCKWAND BELEUCHTET MIT LED.

COD. 885I



- ESPOSITORE EXPO-LIGHT CM 80X125, STRUTTURA IN ALLUMINIO ANODIZZATO, 3 PIANETTI IN CRISTALLO. IMMAGINE SOSTITUIBILE RETROILLUMINATA A LED.
- EXPO-LIGHT WALL SHELVING UNIT CM. 80X125, ANODIZED ALU-MINIUM STRUCTURE, 3 ADJUSTABLE GLASS SHELVES, REPLACE-ABLE IMAGE, LED BACKLIGHTING.
- PRÉSENTOIR EXPO-LIGHT CM 80X125, STRUCTURE ALUM. ANO-DISÉ, 3 TABLETTES RÉGLABLES CRISTAL, IMAGE REMPLAÇABLE RÉTRO-ÉCLAIRÉ A LED.
- VERKAUFSREGAL EXPO-LIGHT CM 80X125 - ALU STRUKTUR, KRISTALL FLÄCHER. BILD AUSWÄCHSELBAR UND RÜCKWAND BE-LEUCHTET MIT LED.

COD. FIN



- SUPPLEMENTO PER COPPIA ANTINE IN FINITURE LEGNI.
- COUPLE CABINET DOORS IN WOODEN FINISHINGS.
- SUPPLÉMENT POUR 2 PORTES EXTRA EN FINITIONS BOIS A CHOIX.
- ZUSCHLAG FÜR 2 TÜREN AUF HOL-Z-ENDBEARBEITUNGEN.

COD. ANT



- SUPPLEMENTO BOCCA DI LUPO CON CESTELLO.
- TILT-AND-TURN DOOR WITH TOWEL-BASKET.
- PORTE OSCILLO-BATTANTE + PORTE SERVIETTES.
- DREHKIPPTÜR MIT KORB.

LABORATORIO

INSTALLAZIONE / INSTALLATION
INSTALLATION / INSTALLATION

ACCESSORI - ACCESSORIES - ACCESSOIRES - ZUBEHÖR

- COD. 816**
- TOP IN SOLID CORE + ALZATA CM
 - TOP IN SOLID CORE + WALL SUPPORT CM
 - PLAN DE TRAVAIL ET PETITE REMONTÉE CM
 - OBERTEIL AUS SOLID CORE + AUFSTIEG CM
- COD. 817**
- ZOCCOLO SPECIALE AL CM LINEARE
 - BASE COVER LINEAR CENTIMETER PRICE
 - SOCLE SPÉCIAL PRIX AU CM LINEAIRE
 - SPEZIELLE SOCKEL KOSTEN PRO ZENTIMTER
- COD. 818**
- PORTA FLACONI KIT 4 PZ
 - KIT 4 PIECES SHAMPOO HOLDER
 - SUPPORT PORTE-SHAMPOOING (4 FLACONS)
 - FLASCHEHALTER (4 STÜCKE)
- COD. ANT**
- SUPPLEM. BOCCA DI LUPO CON CESTELLO
 - TILT-AND-TURN DOOR WITH TOWEL BASKET
 - PORTE OSCILLO-BATTANTE+PORTE SERVIETTES
 - DREHKIPP TÜR MIT KORB

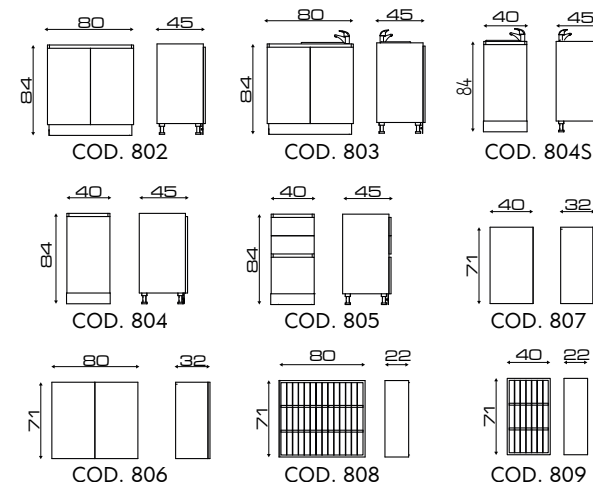

- COD.803**
- MOBILE BASE 80 CM CON LAVABO, ANTE IN FIN. LEGNI, COMPLETO DI TOP, ALZATA E ZOCCOLO.
 - CABINET 80 CM WITH BASIN, WOODEN FINISHING DOORS, TOP, WALL SUPPORT AND BASE COVER.
 - MEUBLE CM 80 AVEC CUVETTE, PORTES EN FINITIONS BOIS, PLAN DE TRAVAIL POUR LE DESSUS DU MEUBLE ET PETITE REMONTÉE, SOCLE.
 - SERVICE SCHRANK, MIT BECKEN, CM 80, 2 TÜREN IN HOLZBESCHICHTUNGEN MIT AUFSTIEG UND SOCKEL.

- COD.802**
- MOBILE BASE 80 CM, ANTE IN FINITURE LEGNI, COMPLETO DI TOP, ALZATA E ZOCCOLO.
 - CABINET 80 CM, WOODEN FINISHING DOORS, TOP, WALL SUPPORT AND BASE COVER.
 - MEUBLE CM 80, PORTES EN FINITIONS BOIS, PLAN DE TRAVAIL POUR LE DESSUS DU MEUBLE ET PETITE REMONTÉE, SOCLE.
 - SERVICE SCHRANK MIT BECKEN CM 80, 2 SCHRANKTÜREN IN HOLZBESCHICHTUNGEN MIT AUFSTIEG UND SOCKEL.

- COD.804.S**
- MOBILE BASE 40 CM CON LAVABO, ANTE IN FIN. LEGNI, COMPLETO DI TOP, ALZATA E ZOCCOLO.
 - CABINET 40 CM WITH BASIN, WOODEN FINISHING DOOR, TOP, WALL SUPPORT AND BASE COVER.
 - MEUBLE CM 40 AVEC CUVETTE, PORTE EN FINITIONS BOIS, PLAN DE TRAVAIL POUR LE DESSUS DU MEUBLE ET PETITE REMONTÉE, SOCLE.
 - SERVICE SCHRANK, MIT BECKEN, CM 40, 1 TÜR IN HOLZBESCHICHTUNGEN MIT AUFSTIEG UND SOCKEL.

- COD.804**
- MOBILE BASE DA 40 CM CON ANTA IN FINITURE LEGNI, COMPLETO DI TOP, ALZATA E ZOCCOLO.
 - CABINET 40 CM, WOODEN FINISHINGS DOOR, TOP, WALL SUPPORT AND BASE COVER.
 - MEUBLE CM 40 AVEC PORTE EN FINITIONS BOIS, PLAN DE TRAVAIL POUR LE DESSUS DU MEUBLE ET PETITE REMONTÉE, SOCLE.
 - SERVICE SCHRANK CM 40, 1 TÜR IN HOLZBESCHICHTUNGEN MIT AUFSTIEG UND SOCKEL.

- COD.805**
- MOBILE BASE DA CM 40 CON 2 CASSETTI E 1 ANTA IN FINITURE LEGNI, CON TOP ALZATA E ZOCCOLO.
 - CABINET 40 CM, 2 DRAWERS AND 1 DOOR, WOODEN FINISHING, TOP, WALL SUPPORT AND BASE.
 - MEUBLE CM 40, 2 TIROIRS, 1 PORTE EN FINITIONS BOIS PLAN DE TRAVAIL POUR LE DESSUS ET PETITE REMONTÉE, SOCLE.
 - SERVICE SCHRANK CM 40 MIT 2 SCHUBLADEN UND 1 TÜR HOLZBESCHICHTUNGEN MIT AUFSTIEG UND SOCKEL.

- COD.807**
- PENSILE DA CM 40 CON ANTA IN FINITURE LEGNI.
 - WALL UNIT 40 CM, WOODEN FINISHING DOOR.
 - MEUBLE MURAL CM 40, AVEC PORTE DISPONIBLE EN FINITIONS BOIS.
 - HÄNGESCHRÄKE CM 40 MIT TÜR VERFÜGBAR IN HOLZBESCHICHTUNGEN.

- COD.806**
- PENSILE DA CM 80 CON ANTA IN FINITURE LEGNI.
 - WALL UNIT 80 CM, WOODEN FINISHING DOORS.
 - MEUBLE MURAL CM 80, AVEC PORTES DISPONIBLE EN FINITIONS BOIS.
 - HÄNGESCHRÄKE CM 80 MIT TÜR VERFÜGBAR IN HOLZBESCHICHTUNGEN.

- COD. 808**
- PENSILE A GIORNO CM 80 PORTA TINTE
 - COLOR BAR, 80 CM.
 - PRÉSENTOIR MURAL CM 80 PORTE TUBES DE COLORATION.
 - HÄNGESCHRÄKE AUF SICHT, CM 80 HAARTÖNUNGHALTER.

- COD. 809**
- PENSILE A GIORNO CM 40 PORTA TINTE
 - COLOR BAR, 40 CM.
 - PRÉSENTOIR MURAL CM 40 PORTE TUBES DE COLORATION.
 - HÄNGESCHRÄKE AUF SICHT, CM 40 HAARTÖNUNGHALTER.





POSTI LAVORO STYLING UNITS COIFFEUSES FRISIERSPLÄTZE

IT LE POSTAZIONI PARRUCCHIERE E BARBER HANNO UN RUOLO IMPORTANTE E MOLTEPLICE ALL'INTERNO DEL SALONE:

- COMPLETANO E DEFINISCONO I DETTAGLI DELLO STILE DI ARREDO
- SVOLGONO UN RUOLO DI "TRAIT D'UNION" TRA IL CLIENTE E LO STILISTA, CONSENTENDO UN DIALOGO COSTANTE
- SUPPORTANO ALCUNI STRUMENTI DI LAVORO DELL'ACCONCIATORE COSÌ COME GLI OGGETTI DEL CLIENTE
- RIFLETTONO IL LAVORO DELLO STILISTA E CONSENTONO AI CLIENTI DI AMMIRARE ALLO SPECCHIO L'ANIMA DEL LORO NUOVO STILE

LE POSTAZIONI DI LAVORO PIETRANERA RISPONDONO ALLE ESIGENZE DI STILI DIVERSI, DAL CONTEMPORANEO AL CLASSICO, DAL MINIMAL ALL' INDUSTRIAL, PER POTERE REALIZZARE IL VOSTRO SALONE DA SOGNO. SONO REALIZZATI CON I MIGLIORI MATERIALI E SONO FUNZIONALI, COMODI E ROBUSTI.

EN HAIRSTYLIST AND BARBER STYLING UNITS PLAY AN IMPORTANT AND MULTIPLE ROLE IN THE SALON:

- THEY COMPLETE AND DEFINE THE DETAILS OF THE FURNISHING STYLE
- THEY ARE A "TRAIT D'UNION" BETWEEN THE CLIENT AND THE STYLIST, ALLOWING A CONSTANT DIALOGUE
- THEY SUPPORT SOME OF THE HAIRDRESSER'S TOOLS AS WELL AS THE CLIENT'S OBJECTS
- THEY REFLECT THE STYLIST'S WORK AND ALLOW CLIENTS TO ADMIRE IN THE MIRROR THE SOUL OF THEIR NEW STYLE

PIETRANERA STYLING UNITS RESPOND TO THE NEEDS OF DIFFERENT STYLES, FROM CONTEMPORARY TO CLASSIC, FROM MINIMAL TO INDUSTRIAL, TO MAKE YOUR DREAM SALON COME TRUE. THEY ARE MADE WITH THE BEST MATERIALS AND ARE FUNCTIONAL, COMFORTABLE AND ROBUST.

FR LES POSTES DE COIFFAGE POUR COIFFEUR ET BARBIER ONT UN RÔLE IMPORTANT ET MULTIPLE AU SEIN DU SALON :

- ILS COMPLÈTENT ET DÉFINISSENT LES DÉTAILS DU STYLE D'AMEUBLEMENT
- ILS JOUENT LE RÔLE DE TRAIT D'UNION ENTRE LE CLIENT ET LE STYLISTE, PERMETTANT UN DIALOGUE CONSTANT
- ILS PERMETTENT AU COIFFEUR DE POSER SES INSTRUMENTS DE TRAVAIL ET AU CLIENT DE POSER SES AFFAIRES
- ILS REFLÈTENT LE TRAVAIL DU STYLISTE EN PERMETTANT AUX CLIENTS D'ADMIRER AU MIROIR L'ESPRIT DE LEUR NOUVEAU STYLE

LES POSTES DE COIFFAGE PIETRANERA RÉPONDENT AUX EXIGENCES DE DIFFÉRENTS STYLES, DU CONTEMPORAIN AU CLASSIQUE, DU MINIMALISTE À L'INDUSTRIEL, AFIN DE RÉALISER VOTRE SALON DE RÊVE. ILS SONT FABRIQUÉS AVEC LES MEILLEURS MATÉRIAUX, SONT FONCTIONNELS, CONFORTABLES ET ROBUSTES.

DE FRISIER- UND BARBIERARBEITSPLÄTZE SPIELEN IM SALON EINE MASSGEBENDE ROLLE:

- SIE VERVOLLSTÄNDIGEN UND DEFINIEREN DIE DETAILS DES EINRICHTUNGSSTILS
- SIE SIND EINE „TRAIT D'UNION“-ROLLE ZWISCHEN DEM KUNDEN UND DEM HAIR STYLISTEN UND ERMÖGLICHEN EINEN STÄNDIGEN DIALOG
- SIE UNTERSTÜTZEN EINIGE DER ARBEITSWERKZEUGE DES FRISEURS SOWIE DIE OBJEKTE DES KUNDEN
- SIE UNTERSTÜTZEN EINIGE DER ARBEITSWERKZEUGE DES FRISEURS SOWIE DIE OBJEKTE DES KUNDEN - SIE SPIEGELN DIE ARBEIT DES STYLISTEN WIDER UND ERMÖGLICHEN ES DEN KUNDEN, IM SPIEGEL DIE SEELE IHRES NEUEN STILS ZU BEWUNDERN.

PIETRANERA-ARBEITSPLÄTZE REAGIEREN AUF DIE BEDÜRFNISSE DER VERSCHIEDENEN STILE, VON ZEITGENÖSSISCH BIS KLAS-SISCH, VON MINIMALISTISCH BIS INDUSTRIELL, UM IHREN TRAUMSALON WIRKLICHKEIT WERDEN ZU LASSEN. SIE WERDEN AUS DEN BESTEN MATERIALIEN HERGESTELLT UND SIND FUNKTIONELL, BEQUEM UND ROBUST.

AURA

INSTALLAZIONE / INSTALLATION
INSTALLATION / INSTALLATION

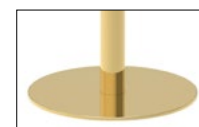
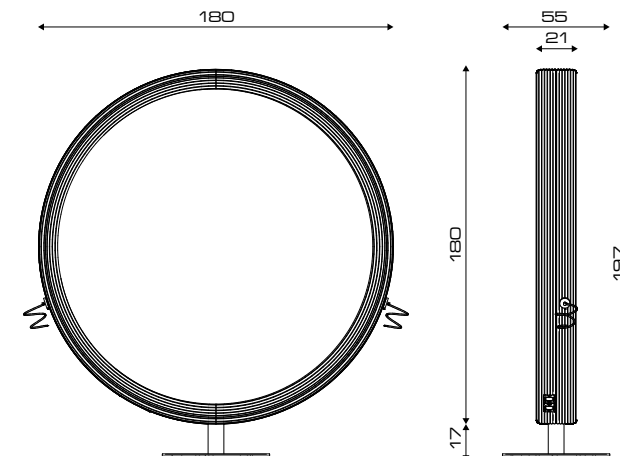

COD. GOLD

COLORI STANDARD
STANDARD COLORS
COULEURS STANDARD
STANDARD FARBEN



BIANCO OPACO
MATT WHITE
BLANC MAT
MATT WEISS



COD. 130



COD. 130G

- PRODOTTI
- PRODUCTS
- PRODUITS
- PRODUKTEN

- ACCESSORI
- ACCESSORIES
- ACCESSOIRES
- ZUBEHÖR



COD. 840

- MENSOLA CENTRALE 2 POSTI LAVORO CON STRUTTURA VERNICIATA BIANCO OPACO, PARTI IN METALLO CROMATO.
- 2-PLACE ISLAND, MATT WHITE PAINTED WOOD STRUCTURE, DETAILS IN CHROMED METAL.
- COIFFEUSE CENTRALE 2 PLACES, STRUCTURE EN BOIS PEINT BLANC MAT, DÉTAILS EN MÉTAL CHROMÉ.
- FRISIERPLATZ FREESTANDING 2 PLÄTZE, STRUKTUR WEISS LACKIERT, TEILE AUS VERCHROMTEM METALL.

COD. 130

- PORTA PHON CROMATO (2 PEZZI).
- CHROMED DRYERHOLDER (2 PIECES).
- PORTE-SÉCHOIR CHROMÉ (2 PIÈCES).
- VERCHROMTEN FÖNHALTERUNG (2 STÜCKE).

COD. 130G

- PORTA PHON CROMATO ORO (2 PEZZI).
- GOLD CHROMED DRYERHOLDER (2 PIECES).
- PORTE-SÉCHOIR CHROMÉ OR (2 PIÈCES).
- VERCHROMTEN GOLD FÖNHALTERUNG (2 STÜCKE).

COD. ILL

- ILLUMINAZIONE A LED.
- LED BACKLIGHTING.
- ILLUMINATION À LED.
- LED BELEUCHTUNG.

COD. GOLD

- SUPPLEMENTO PIEDE COLORE ORO.
- EXTRA CHARGE FOR GOLD PAINTED BASE.
- SUPPLEMENT PEINTURE PIED COULEUR OR.
- ZUSCHLAG FÜR GOLD VERSION FUSS (FÜR INSELL).

COD. FIN

- SUPPLEMENTO COLORE NERO OPACO PER CORNICE
- MAT BLACK FRAME COLORS PAINTING.
- COULEUR SPÉCIALE STRUCTURE MAT NOIR.
- ZUSCHLAG FÜR MATT SCHWARZ FARBE.

AURA PARETE

INSTALLAZIONE / INSTALLATION
INSTALLATION / INSTALLATION

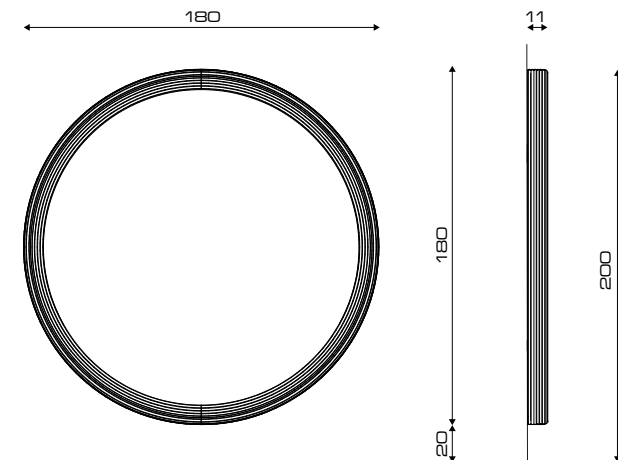
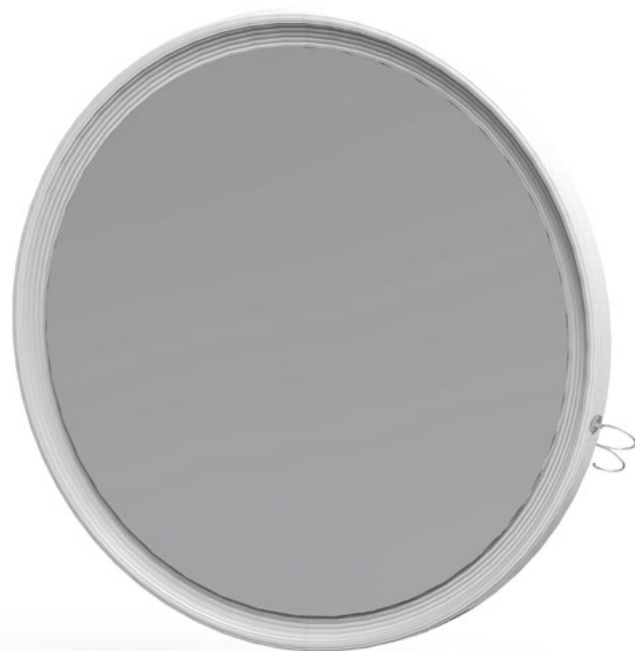

• COLORI STANDARD
• STANDARD COLORS
• COULEURS STANDARD
• STANDARD FARBEN



• BIANCO OPACO
• MATT WHITE
• BLANC MAT
• MATT WEISS



COD. 130



COD. 130G

• PRODOTTI
• PRODUCTS
• PRODUITS
• PRODUKTEN

• ACCESSORI
• ACCESSORIES
• ACCESSOIRES
• ZUBEHÖR

COD. 130

• PORTA PHON CROMATO (1 PEZZO).
• CHROMED DRYERHOLDER (1 PIECE).
• PORTE-SÉCHOIR CHROMÉ (1 PIÈCE).
• VERCHROMTEN FÖNHALTERUNG (1 STÜCK).

COD. 130G

• PORTA PHON CROMATO ORO (1 PEZZO).
• GOLD CHROMED DRYERHOLDER (1 PIECE).
• PORTE-SÉCHOIR CHROMÉ OR (1 PIÈCE).
• VERCHROMTEN GOLD FÖNHALTERUNG (1 STÜCK).

COD. FIN

• SUPPLEMENTO COLORE NERO OPACO PER CORNICE
• MAT BLACK FRAME COLORS PAINTING.
• COULEUR SPÉCIALE STRUCTURE MAT NOIR.
• ZUSCHLAG FÜR MATT SCHWARZ FARBE.

COD. ILL

• ILLUMINAZIONE A LED
• LED BACKLIGHTING
• ILLUMINATION À LED
• LED BELEUCHTUNG

COD. 841

• MENSOLA A PARETE CON STRUTTURA VERNICIATA BIANCO OPACO.
• WALL STYLING UNIT, MATT WHITE PAINTED WOOD STRUCTURE.
• COIFFEUSE MURALE, STRUCTURE EN BOIS PEINT BLANC MAT.
• FRISIERPLATZ, STRUKTUR WEISS LACKIERT.



ARYA

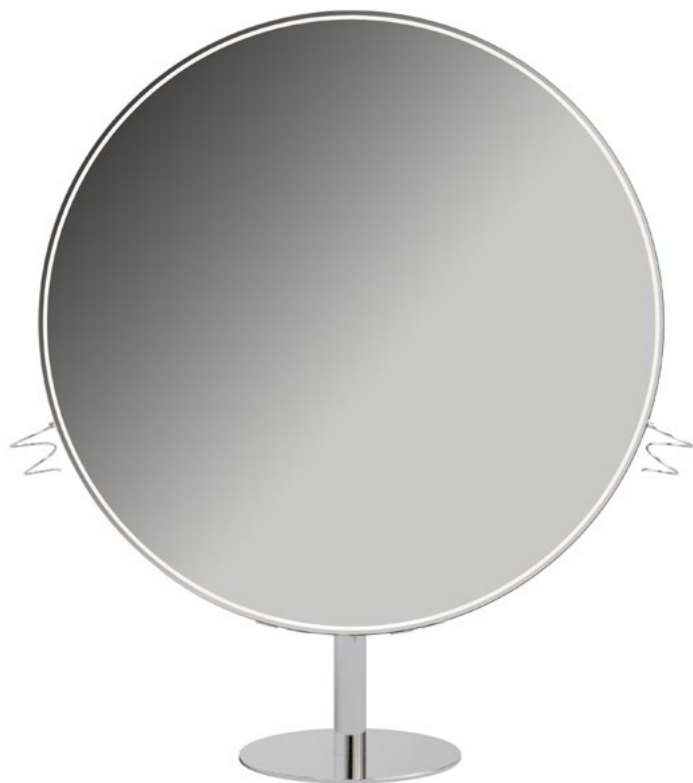

COD. 844

- PRODOTTI
- PRODUCTS
- PRODUITS
- PRODUKTEN



COD. 844 + FIN

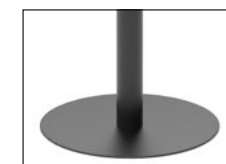
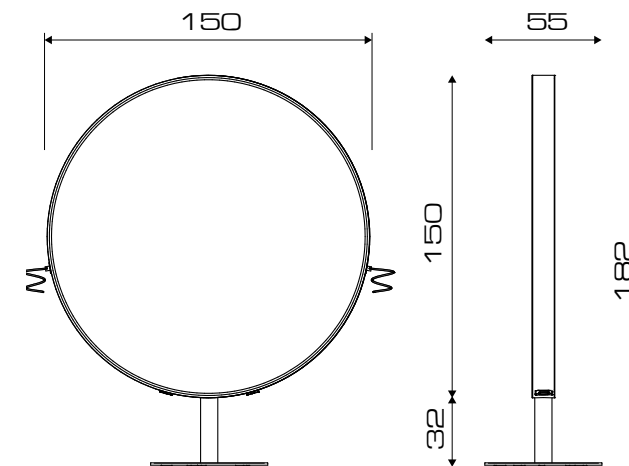

COD. FIN

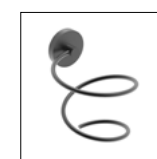

COD. 130.N

- ACCESSORI
- ACCESSORIES
- ACCESSOIRES
- ZUBEHÖR



COD. 844

- MENSOLA CENTRALE 2 POSTI LAVORO CON CORNICE E PARTI IN METALLO CROMATO E 2 PORTAPHON CROMATI.
- 2-PLACE ISLAND, CHROME-PLATED METAL FRAME AND PARTS AND 2 CHROMED HAIR DRYER HOLDER.
- COIFFEUSE CENTRALE 2 PLACES, CADRE ET PIÈCES EN MÉTAL CHROMÉ ET 2 PORTE SÈCHE CHEVEUX CHROMÉES.
- FRISIERPLATZ FREESTANDING 2 PLÄTZE, VERCHROMTER METALLRAHMEN UND TEILE UND 2 CHROM-HAARTROCKNERHALTER.

COD. ILL

- ILLUMINAZIONE A LED.
- LED BACKLIGHTING.
- ILLUMINATION À LED.
- LED BELEUCHTUNG.

COD. 130.N

- PORTA PHON COLORE NERO OPACO (2 PEZZI).
- DRYERHOLDER MATT BLACK COLOR (2 PIÈCES).
- PORTE-SÉCHOIR COULEUR NOIR MAT (2 PIÈCES).
- FÖNHALTERUNG MATT SCHWARZE FARBE (2 STÜCKE).

COD. FIN

- SUPPLEMENTO VERNICE BASE NERA
- BLACK BASE PAINT EXTRA CHARGE
- SUPPLÉMENT PEINTURE BASE NOIRE
- SCHWARZER BASISLACKZUSATZ

LUNA

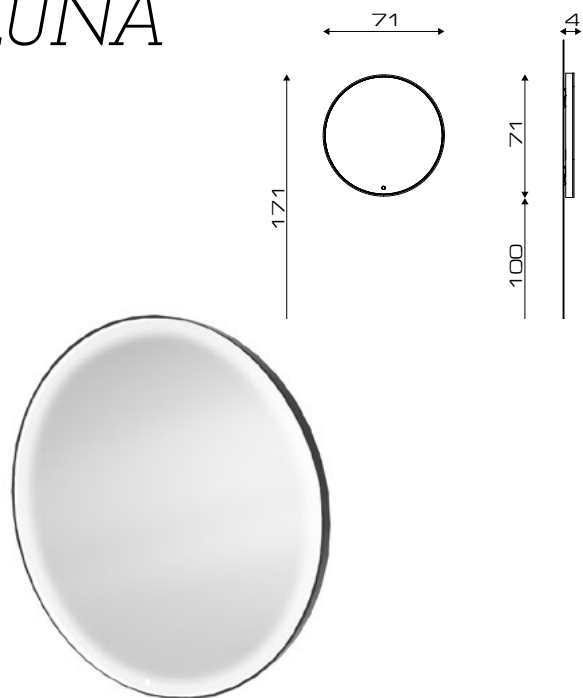

COD. 856

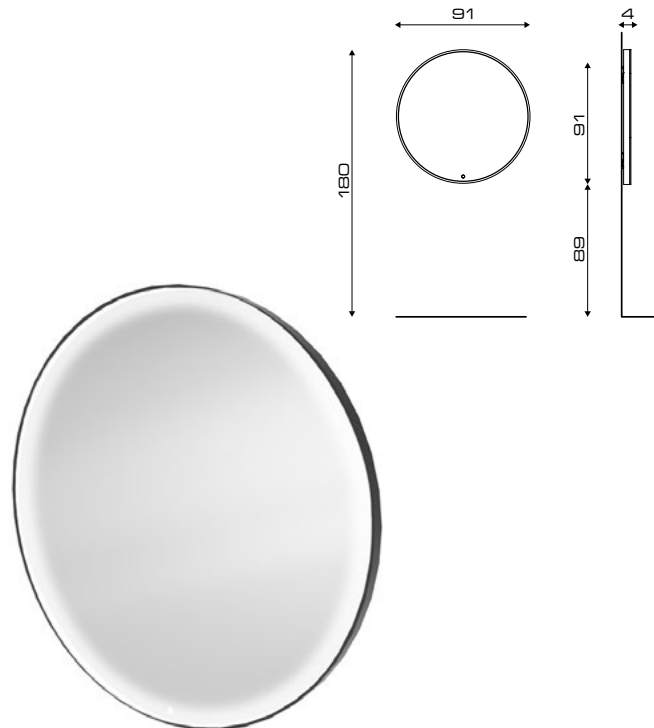

COD. 857

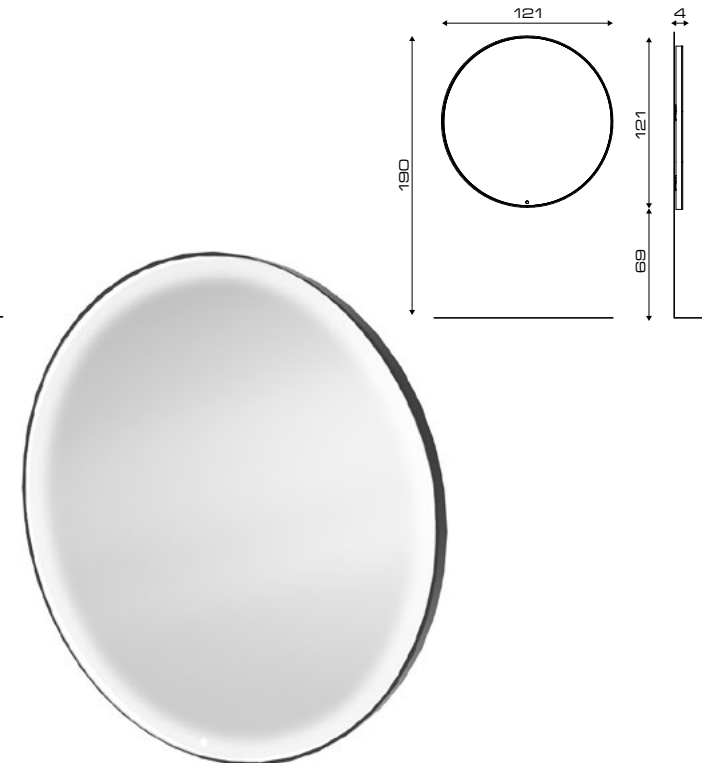

COD. 858

PRODOTTI
PRODUCTS
PRODUITS
PRODUKTEN

COD. 856



- SPECCHIERA CIRCOLARE DIAMETRO 71 CM, ILLUMINAZIONE LED CON INTERRUTTORE E DIMMER, CORNICE COLORE NERO.
- CIRCULAR MIRROR DIAMETER 71 CM, LED ILLUMINATION WITH SWITCH AND DIMMER, BLACK FRAME.
- MIROIR CIRCULAIRE DIAMÈTRE 71 CM, LED ILLUMINATION AVEC INTERRUPTEUR ET DIMMER, CADRE NOIR.
- RUNDSPIEGEL DURCHMESSER 71 CM, LED-BELEUCHTUNG MIT SCHALTER UND DIMMER, SCHWARZER RAHMEN

COD. 857



- SPECCHIERA CIRCOLARE DIAMETRO 91 CM, ILLUMINAZIONE LED CON INTERRUTTORE E DIMMER, CORNICE COLORE NERO.
- CIRCULAR MIRROR DIAMETER 91 CM, LED ILLUMINATION WITH SWITCH AND DIMMER, BLACK FRAME.
- MIROIR CIRCULAIRE DIAMÈTRE 91 CM, LED ILLUMINATION AVEC INTERRUPTEUR ET DIMMER, CADRE NOIR.
- RUNDSPIEGEL DURCHMESSER 91 CM, LED-BELEUCHTUNG MIT SCHALTER UND DIMMER, SCHWARZER RAHMEN

COD. 858



- SPECCHIERA CIRCOLARE DIAMETRO 121 CM, ILLUMINAZIONE LED CON INTERRUTTORE E DIMMER, CORNICE COLORE NERO.
- CIRCULAR MIRROR DIAMETER 121 CM, LED ILLUMINATION WITH SWITCH AND DIMMER, BLACK FRAME.
- MIROIR CIRCULAIRE DIAMÈTRE 121 CM, LED ILLUMINATION AVEC INTERRUPTEUR ET DIMMER, CADRE NOIR.
- RUNDSPIEGEL DURCHMESSER 121 CM, LED-BELEUCHTUNG MIT SCHALTER UND DIMMER, SCHWARZER RAHMEN

BELLEVUE

INSTALLAZIONE / INSTALLATION
INSTALLATION / INSTALLATION





COD. 892N

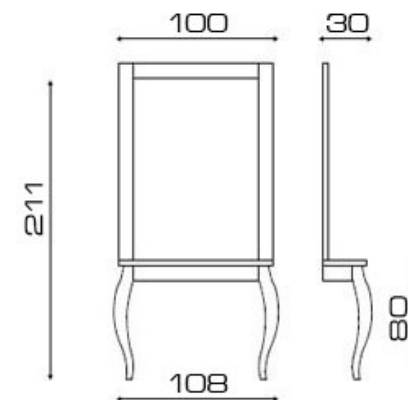

COD. 890



- COLORI STANDARD
 - STANDARD COLORS
 - COULEURS STANDARD
 - STANDARD FARBEN
- | | |
|---|---|
|  | <ul style="list-style-type: none"> •NERO LUCIDO •GLOSSY BLACK •NOIR BRILLANT •GLÄNZEND SCHWARZ |
|  | <ul style="list-style-type: none"> •BIANCO LUCIDO •GLOSSY WHITE •BLANC BRILLANT •GLÄNZEND WEISS |

- PRODOTTI
- PRODUCTS
- PRODUITS
- PRODUKTEN



COD. 890

- CONSOLLE LACCATA BIANCA, SPECCHIO CORNICE BAROCCA ORO.
- LACQUERED WHITE CONSOLLE WITH MIRROR BAROQUE GOLD FRAME.
- CONSOLE LAQUÉE BLANC, MIROIR AVEC ENCADREMENT BAROQUE OR.
- FRISIERPLATZ GLANZWEISS, SPIEGEL MIT BAROCK GOLD RAHMEN.



COD. 891

- CONSOLLE LACCATA NERA, SPECCHIO CORNICE BAROCCA ORO.
- LACQUERED BLACK CONSOLLE WITH MIRROR BAROQUE GOLD FRAME.
- CONSOLE LAQUÉE NOIR, MIROIR AVEC ENCADREMENT BAROQUE OR.
- FRISIERPLATZ GLANZSCHWARZ, SPIEGEL MIT BAROCK GOLD RAHMEN.



COD. 892B

- CONSOLLE LACCATA BIANCA, SPECCHIO CORNICE BIANCA.
- LACQUERED WHITE CONSOLLE WITH MIRROR WHITE FRAME.
- CONSOLE LAQUÉE BLANC, MIROIR AVEC ENCADREMENT BLANC.
- FRISIERPLATZ GLANZWEISS, SPIEGEL MIT WEISS RAHMEN.



COD. 892N

- CONSOLLE LACCATA NERA, SPECCHIO CORNICE NERO.
- LACQUERED BLACK CONSOLLE WITH MIRROR BLACK FRAME.
- CONSOLE LAQUÉE NOIR, MIROIR AVEC ENCADREMENT NOIR.
- FRISIERPLATZ GLANZSCHWARZ, SPIEGEL MIT SCHWARZ RAHMEN.

CODE



COD. 842 + 843

INSTALLAZIONE / INSTALLATION
INSTALLATION / INSTALLATION

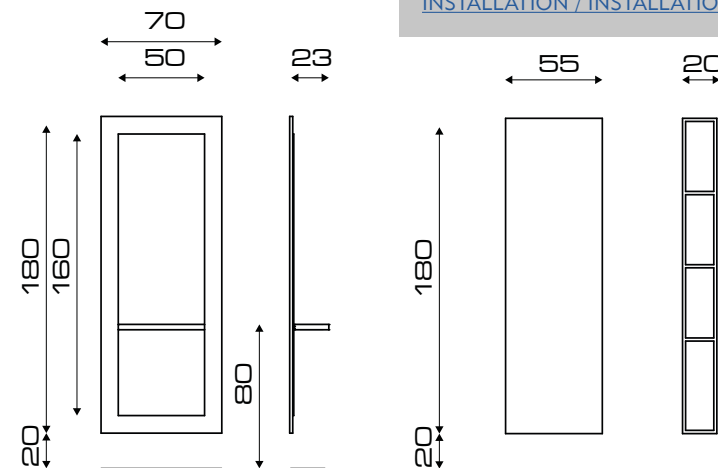

COD. 842

COD. 843



COD. 901



COD. 963

- PRODOTTI
- PRODUCTS
- PRODUITS
- PRODUKTEN

COD. 842

- MENSOLA A PARETE DISPONIBILE IN FINITURE LEGNI, CON PIANO IN ACCIAIO INOX, PRAL O FINITURE LEGNO, PORTAPHON.
- STYLING UNIT MELAMINE-FACED AVAILABLE IN WOODEN FINISHINGS, ST. STEEL, PRAL OR WOODEN SHELF, + BLOW-DRYER HOLDER.
- COIFFEUSE EN FINITIONS BOIS AU CHOIX, TABLETTE EN ACIER INOX, PRAL OU BOIS, PORTE-SÉCHOIR.
- WANDARBEITSPLATZ MIT ABLAGE AUS EDELSTAHL, PRAL ODER HOLZ, PHÖNHALTER

COD. 843

- SERVER RETRO MENSOLA DISPONIBILE IN FINITURE LEGNI
- BACK CABINET SERVER AVAILABLE IN WOODEN FINISHINGS
- SERVICE DERRIÈRE PANNEAU EN FINITIONS BOIS AU CHOIX
- RÜCKSEITE SERVICE MÖBEL AUS HOLZ

- PIANETTO
- SHELF
- TABLETTE
- ABLAGE

- ACCESSORI
- ACCESSORIES
- ACCESSOIRES
- ZUBEHÖR

- INOX
- INOX
- ACIER INOX
- EDELSTAHL

- FIN. LEGNI
- WOOD FINISH. SHELF
- FINITION BOIS
- HOLZBESCHICHTUNGEN

- PRAL
- PRAL
- PRAL
- PRAL

COD. 963

- PORTAPHON A SCOMPARSA
- RETRACTABLE BLOW-DRYER HOLDER
- PORTE-SÉCHOIR EXTRACTIBLE
- EINZIEHBARE PHÖNHALTER

COD. 901

- PORTAPHON SNOVABILE CROMATO PER MENSOLA.
- SWIVEL CHROME-PLATED HAIRDRYER HOLDER FOR SHELF.
- PORTE-SÉCHOIR ARTICULÉ CHROMÉ POUR TABLETTE.
- VERCHROMTER GELENK HAARTROCKNERHALTER FÜR FLACHBETT

DUPLEX

INSTALLAZIONE / INSTALLATION
INSTALLATION / INSTALLATION



COD. 957

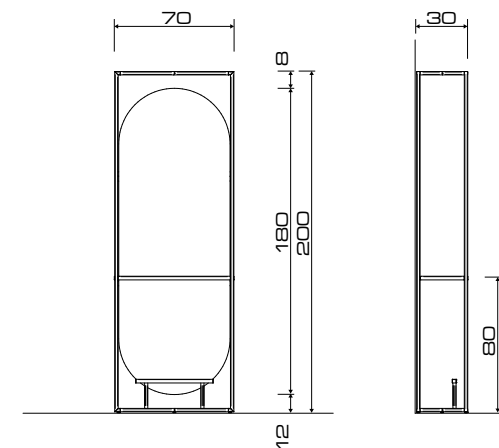

[PAG.215](#)



[PAG.214](#)

- PRODOTTI
- PRODUCTS
- PRODUITS
- PRODUKTEN

- PIANETTO
- SHELF
- TABLETTE
- ABLAGE

- ACCESSORI
- ACCESSORIES
- ACCESSOIRES
- ZUBEHÖR



COD. 957

- POSTO LAVORO A PARETE, STRUTTURA E PIANO IN METALLO VERNICIATI COLORE ARGILLA, PORTAPHON CROMATO.
- WALL STYLING UNIT, STRUCTURE AND SHELF IN PAINTED METAL COLOUR CLAY. CHROME DRYER HOLDER.
- COIFFEUSE AVEC STRUCTURE ET TABLETTE EN MÉTAL PEINTS COULEUR "CLAY". PORTESÉCHOIR CHROMÉ.
- FRISIERPLATZ MIT STRUKTUR UN ABLAGE AUS METALL, LEHM FARBE LACKIERT, VERCHROMTEN FÖNHALTERUNG



- FIN. METALLI
- METALS FINISH.
- FINITION DE METAUX
- METALLE BESCHICHTUNGEN



- FIN. LEGNI
- WOOD FINISHING
- FINITION BOIS
- HOLZBEREICHEN

COD. FIN

- COLORI SPECIALI VERNICIATURA DELLA STRUTTURA E DEI PIANI.
- METAL PAINTING IN SPECIAL COLORS FOR STRUCTURE AND SHELVES.
- AUTRE COULEUR DU MÉTAL STRUCTURE ET ÉTAGÈRES DANS LES FINITION MÉTAL.
- SPEZIALFARBEN LACKIERUNG FÜR STRUKTUR UND REGALE.

COD. 131

- PIANETTO IN FINITURE LEGNI
- WOODEN FINISHING SHELF
- TABLETTE EN FINITION BOIS
- ABLAGE AUS HOLZBEREICHEN

FRAIM



COD.948



COD.949



COD.950

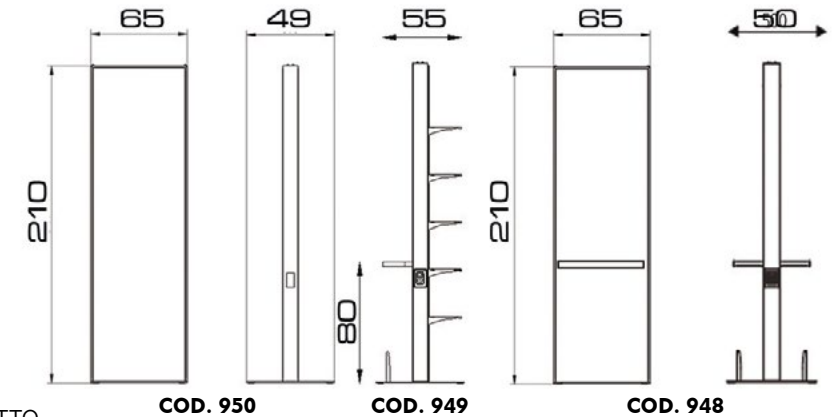

- PIANETTO
- SHELF
- TABLETTE
- ABLAGE



- INOX
- INOX
- ACIER INOX
- EDELSTAHL



- FIN. LEGNI
- WOOD FINISH. SHELF
- FINITION BOIS
- HOLZBESCHICHTUNGEN



- PRAL
- PRAL
- PRAL
- PRAL

[PAG.212 -213](#)

[PAG.214](#)

PRODOTTI - PRODUCTS - PRODUITS - PRODUKTEN

ACCESSORI - ACCESSORIES - ACCESSOIRES - ZUBEHÖR



COD.948

- MENSOLA CENTRALE 2 POSTI, PIANO IN INOX, PRAL O FINITURE LEGNO, PORTAPHON, POGGIPIEDI ALLUM. LUCIDO.
- 2 PLACEES ISLAND, SELF SUPPORTING STYLING UNIT, ST.STEEL, PRAL OR WOODEN SHELVES, BLOW-DRYER HOLDERS.
- COIFFEUSE CENTRALE A 2 PLACES, TABLETTES EN ACIER INOX, PRAL OU BOIS, PORTESÉCHOIR, REPOSE-PIEDS ALUMINIUM POLI.
- 2-ER FREISTEHENDER MITTELFRISEIERPLATZ MIT ABLAGE AUS EDELSTAHL, PRAL ODER HOLZ. PHÖNHALTER, FUSSSTÜTZE AUS ALU-GLÄNZEND.



COD.949

- ISOLA CENTRALE 1 POSTO LAVORO CON PIANO IN INOX, PRAL O FINITURE LEGNO, PORTAPHON, 1 TELO IMMAGINE, POGGIPIEDI ALLUMINIO LUCIDO.
- 1 PLACE ISLAND, SELF SUPPORTING STYLING UNIT, ST.STEEL, PRAL OR WOODEN SHELF + BLOW-DRYER HOLDER + 1 REPLACEABLE PICTURE.
- COIFFEUSE CENTRALE 1 MIROIR AVEC TABLETTE EN ACIER INOX, PRAL OU BOIS, PORTESÉCHOIR, REPOSE-PIEDS ALUMINIUM POLI ET IMAGE REMPLAÇABLE.
- FREISTEHENDER MITTELFRISEIERPLATZ, 1 ARBEITSPLATZ MIT ABLAGE AUS EDELSTAHL, PRAL ODER HOLZ, 1 BILDER DRUCK-STOFF, FUSSSTÜTZE AUS ALU-GLÄNZEND.



COD.950

- ISOLA CENTRALE CON DOPPIA IMMAGINE
- ISLAND UNIT WITH 2 REPLACEABLE PICTURES.
- COIFFEUSE CENTRALE A 2 IMAGES REMPLAÇABLE.
- TWICE MIT DOPPEL BILDER DRUCK-STOFF.

COD. ILL

- ILLUMIN. A LED PER COD. 949,950
- LED LIGHT FOR COD. 949,950
- ILLUMIN. A LED POUR COD. 949,950
- LED BELEUCHTUNG COD. 949,950

COD. 754

- IMMAGINE RICAMBIO PER FRAIM COD. 949, 950
- REPLACEABLE PICTURE FOR FRAIM COD. 949, 950
- IMMAGINE RICAMBIO PER FRAIM COD. 949, 950
- ERSATZBILD FÜR FRAIM COD. 949, 950

COD. 963

- PORTAPHON A SCOMPARSA
- RETRACTABLE BLOW-DRYER HOLDER
- PORTE-SECHOIR EXTRACTIBLE
- EINZIEHBARE PHÖNHALTER

FRAM EXPO

- ILLUMINAZIONE A LED
- LED LIGHT
- ILLUMINATION À LED
- LED BELEUCHTUNG



PAG.212 -213

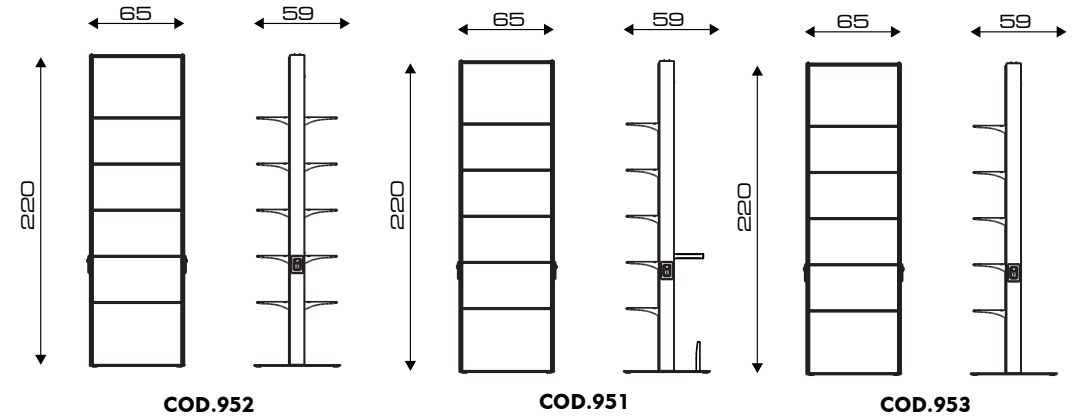

- PIANET-TO
- SHELF
- TABLETTE
- ABLAGE
- INOX
- INOX
- ACIER INOX
- EDELSTAHL
- FIN. LEGNI
- WOOD FINISH. SHELF
- FINITION BOIS
- HOLZBESCHICHTUNGEN
- PRAL
- PRAL
- PRAL
- PRAL

PRODOTTI - PRODUCTS - PRODUITS - PRODUKTEN

ACCESSORI - ACCESSORIES - ACCESSOIRES - ZUBEHÖR



COD.952

- ISOLA CENTRALE CON 2 TELI IMMAGINE RETROILLUMINATI A LED ED ESPOSITORI DA AMBO I LATI.
- ISLAND UNIT WITH 2 REPLACEABLE LED BACKLIGHTE PICTURES AND DISPLAYS ON BOTH SIDES.
- COIFFEUSE CENTRALE, À 2 IMAGES ET 2 COTÉS AVEC PRÉSENTOIRS, RÉTRO-ÉCLAIRAGE.
- FREISTEHENDER VERKAUFSREGAL MIT BILDER DRUCK-STOFF UND GLASS ABLAGEN AUF BEIDEN SEITEN, RÜCKWAND BELEUCHTET MIT LED.



COD.953

- ISOLA CENTRALE CON DUE TELI IMMAGINE RETROILLUMINATI A LED ED ESPOSITORI SU UN LATO.
- ISLAND UNIT WITH 2 REPLACEABLE LED BACKLIGHTE PICTURES AND DISPLAYS ON ONE SIDES.
- COIFFEUSE CENTRALE, 2, IMAGES ET 1 COTÉ AVEC PRÉSENTOIRS ET RÉTRO-ÉCLAIRAGE.
- FREISTEHENDER STRUKTUR MIT 2 BILDER DRUCK-STOFF, RÜCKWAND BELEUCHTET MIT LED UND GLASS ABLAGEN AUF EINER SEITE.



COD.951

- ISOLA CENTRALE 1 POSTO, PIANO IN ACCIAIO INOX, PRAL O FINITURE LEGNO, PORTAPHON, 1 TELO IMMAGINE RETROILLUMINATO A LED ED ESPOSITORI.
- 1 PLACE ISLAND, SELF SUPPORTING STYLING UNIT, ST. STEEL OR PRAL SHELF + 1 REPLACEABLE LED BACKLIGHTE PICTURE AND DISPLAYS.
- COIFFEUSE CENTRALE 1 MIROIR, TABLETTE EN ACIER INOX, PRAL OU BOIS, PORTE SECHOIR, AUTRE COTÉ AVEC IMAGE.
- FREISTEHENDER MITTELFRISEIERPLATZ L, 1 ARBEITSPLATZ MIT ABLAGE AUS EDELSTAHL, PRAL ODER HOLZ. PHÖNHALTER, 1 BILDER DRUCK-STOFF, FUSSSTÜTZE AUS ALU-GLÄNZEND.

COD. 954

- IMMAGINE RICAMBIO PER FRAM COD. 952, 951, 953
- REPLACEABLE PICTURE FOR FRAM COD. 952, 951, 953
- IMMAGINE RICAMBIO PER FRAM COD. 952, 951, 953
- ERSATZBILD FÜR FRAM COD. 952, 951, 953

COD. 963

- PORTAPHON A SCOMPARSA
- RETRACTABLE BLOW-DRYER HOLDER
- PORTE-SECHOIR EXTRACTIBLE
- EINZIEHBARE PHÖNHALTER



HUB

HUB WOOD



COD.643
INOX



COD.644
WOOD

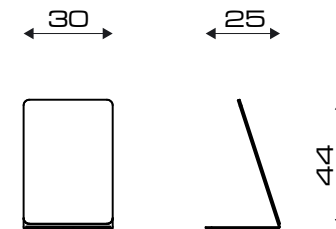

- PRODOTTI
- PRODUCTS
- PRODUITS
- PRODUKTEN



COD.643

- SPECCHIO DA TAVOLO
- TABLE MIRROR
- MIROIR DE TABLE
- TISCHSPIEGEL



COD.644

- SPECCHIO DA TAVOLO CON STRUTTURA WOOD
- TABLE MIRROR WITH WOODEN FRAME
- MIROIR DE TABLE AVEC STRUCTURE EN BOIS
- TISCHSPIEGEL MIT HOLZSTRUKTUR

KING TECNO



INSTALLAZIONE / INSTALLATION
INSTALLATION / INSTALLATION

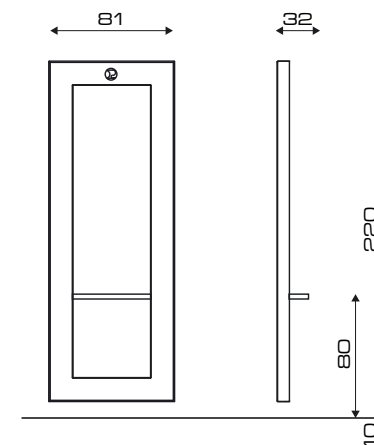

PAG.214

- PRODOTTI
- PRODUCTS
- PRODUITS
- PRODUKTEN

- PIANETTO
- SHELF
- TABLETTE
- ABLAGE

- ACCESSORI
- ACCESSORIES
- ACCESSOIRES
- ZUBEHÖR



COD. 963



COD. 901



COD.931

- MENSOLA IN NOBILITATO FINITURE LEGNI, PIANO ACCIAIO INOX, PRAL O FINITURE LEGNI CON PORTAPHON
- STYLING UNIT AVAILABLE IN WOODEN FIN. -SHELF AVAILABLE IN ST.STEEL, PRAL OR WOODEN FINISHINGS WITH DRYERHOLDER
- COIFFEUSE EN MÉLAMINÉ DISPONIBLE EN FINITIONS BOIS, TABLETTE ACIER INOX, PRAL OU FINITIONS BOIS, AVEC PORTE-SÉCHOIR
- FRISIERPLATZ AUS HOLZBERFLÄCHEN - ABLAGE AUS EDELSTAHL, PRAL ODER HOLZBERFLÄCHEN MIT FÖNHALTERUNG



- INOX
- INOX
- ACIER INOX
- EDELSTAHL



- FIN. LEGNI
- WOOD FINISH. SHELF
- FINITION BOIS
- HOLZBESCHICHTUNGEN



- PRAL
- PRAL
- PRAL
- PRAL

COD. 963

- PORTAPHON A SCOMPARSA
- RETRACTABLE BLOW-DRYER HOLDER
- PORTE-SECHOIR EXTRACTIBLE
- EINZIEHBARE FÖNHALTER

COD. 901

- PORTAPHON SNODABILE CROMATO PER MENSOLA.
- SWIVEL CHROME-PLATED HAIRDRYER HOLDER FOR SHELF
- PORTE-SÉCHOIR ARTICULÉ CHROMÉ POUR TABLETTE.
- VERCHROMTER GELENK HAARTROCKNERHALTER FÜR FLACHBETT

CHARME STATION

- COLORI STANDARD
- STANDARD COLORS
- COULEURS STANDARD
- STANDARD FARBEN



- NERO LUCIDO
- GLOSSY BLACK
- NOIR BRILLANT
- GLÄNZEND SCHWARZ



- BIANCO LUCIDO
- GLOSSY WHITE
- BLANC BRILLANT
- GLÄNZEND WEISS

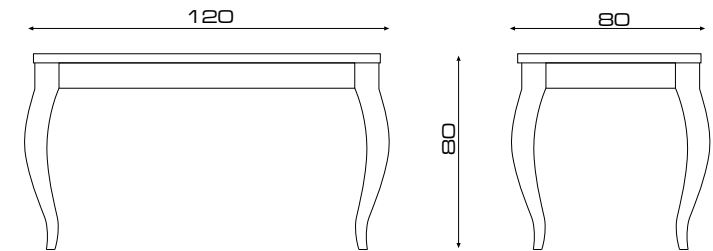
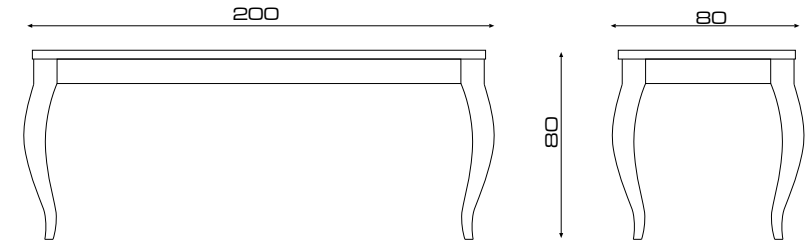

PRODOTTI
PRODUCTS
PRODUITS
PRODUKTEN

COD.895B



- TAVOLO LAVORO 2 POSTI 120X80 CM. H.80 BIANCO LUCIDO.
- WORK STATION 2 PLACES 120X80 CM. H.80 GLOSS WHITE.
- TABLE DE TRAVAIL 2 PLACES 120X80 CM. H.80 BLANC BRILLANT.
- ARBEITSTISCH 2-ER 120X80 CM. H.80 GLANZWEISS

COD.896B



- TAVOLO LAVORO 4 POSTI 200X80 CM. H.80 BIANCO LUCIDO.
- WORK STATION 4 PLACES 200X80 CM. H.80 GLOSS WHITE.
- PLAN DE TRAVAIL 4 PLACES 200X80 CM. H.80 BLANC BRILLANT.
- ARBEITSTISCH 4-ER 200X80 CM. H.80 GLANZWEISS

COD.895N



- TAVOLO LAVORO 2 POSTI 120X80 CM. H.80 NERO LUCIDO.
- WORK STATION 2 PLACES 120X80 CM. H.80 GLOSS BLACK.
- PLAN DE TRAVAIL 2 PLACES 120X80 CM. H.80 NOIR BRILLANT.
- ARBEITSTISCH 2-ER 120X80 CM. H.80 GLANZSCHWARZ.

COD.896N



- TAVOLO LAVORO 4 POSTI 200X80 CM. H.80 NERO LUCIDO.
- WORK STATION 4 PLACES 200X80 CM. H.80 GLOSS BLACK.
- PLAN DE TRAVAIL 4 PLACES 200X80 CM. H.80 NOIR BRILLANT.
- ARBEITSTISCH 4-ER 200X80 CM. H.80 GLANZSCHWARZ.

LIGHT - LIGHT MSL



PAG.214

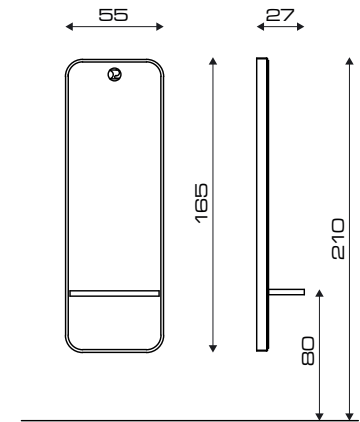

COD. 901



COD. 963

- PRODOTTI
- PRODUCTS
- PRODUITS
- PRODUKTEN

- PIANETTO
- SHELF
- TABLETTE
- ABLAGE

- ACCESSORI
- ACCESSORIES
- ACCESSOIRES
- ZUBEHÖR

LIGHT - COD.853.L



- MENSOLA CON ILLUMINAZIONE LED BIANCA, PIANO ACCIAIO INOX, PRAL O FINITURE LEGNI CON PORTAPHON
- STYLING UNIT - SHELF AVAILABLE IN ST.STEEL, PRAL OR WOODEN FINISHINGS WITH DRYERHOLDERWHITE LED LIGHTING
- COIFFEUSE MURALE- TABLETTE ACIER INOX, PRAL OU FINITIONS BOIS, AVEC PORTE-SÉCHOIR- AVEC ILLUMINATION LED BLANCHE
- FRISIERPLATZ MIT WEISS LED-BELEUCHTUNG, ABLAGE AUS EDELSTAHL, PRAL ODER HOLZBEREICHEN MIT FÖNHÄLTERUNG

LIGHT MSL - COD.853.MSL



- MENSOLA CON ILLUMINAZIONE "MULTICOLOR SYSTEM LED", CON TELECOMANDO, PIANO ACCIAIO INOX, PRAL O FINITURE LEGNI CON PORTAPHON
- STYLING UNIT, SHELF AVAILABLE IN ST.STEEL, PRAL OR WOODEN FINISHINGS WITH DRYERHOLDER WITH "MULTICOLOR SYSTEM LED" AND REMOTE CONTROL
- COIFFEUSE MURALE- TABLETTE ACIER INOX, PRAL OU FINITIONS BOIS, AVEC PORTE-SÉCHOIR- AVEC ÉCLAIR. 'MULTICOLOR SYSTEM LED' ET TÉLÉCOMMANDE
- FRISIERPLATZ MIT "MULTICOLOR SYSTEM LED"-BELEUCHTUNG, MIT FERNBEDIENUNG, ABLAGE AUS EDELSTAHL, PRAL ODER HOLZBEREICHEN MIT FÖNHÄLTERUNG.

- INOX
- INOX
- ACIER INOX
- EDELSTAHL

- FIN. LEGNI
- WOOD FINISH. SHELF
- FINITION BOIS
- HOLZBESCHICHTUNGEN

- PRAL
- PRAL
- PRAL
- PRAL

COD. 963

- PORTAPHON A SCOMPARSA
- RETRACTABLE BLOW-DRYER HOLDER
- PORTE-SÉCHOIR EXTRACTIBLE
- EINZIEHBARE PHÖNHÄLTER

COD. 901

- PORTAPHON SNODABILE CROMATO PER MENSOLA.
- SWIVEL CHROME-PLATED HAIRDYER HOLDER FOR SHELF
- PORTE-SÉCHOIR ARTICULÉ CHROMÉ POUR TABLETTE.
- VERCHROMTER GELENK HAARTROCKNERHALTER FÜR FLACHBETT

LOHMANN

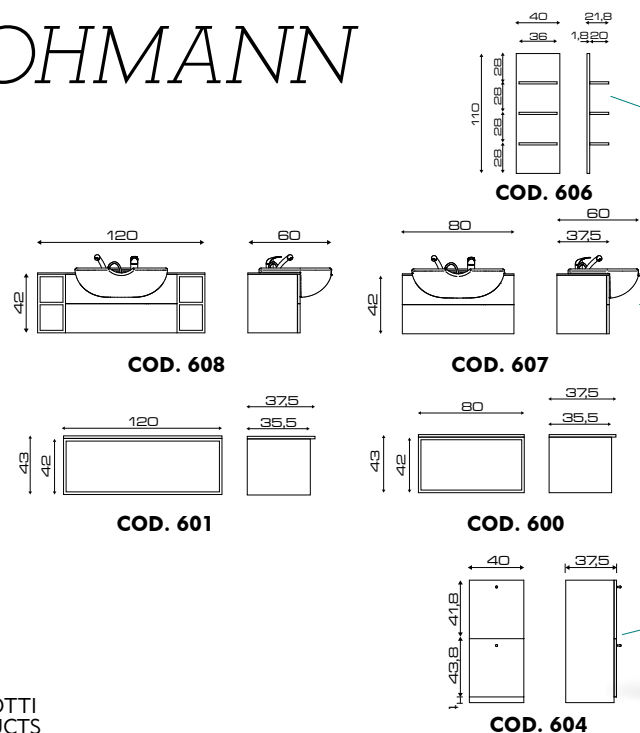

COD. M604/3
PAG. 119

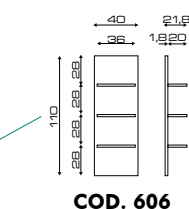

COD. 606

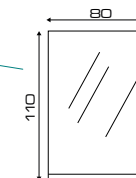

COD. 602

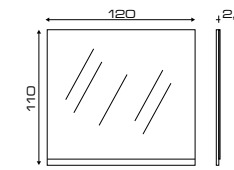

COD. 603

COD. M604/3

COD. M607/1
PAG. 119

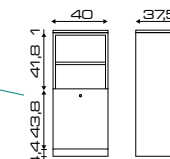

COD. 604

COD. 2X606 + 607 + 604 + 605 + 602 + 2XM604/3 + M607/1

- PRODOTTI
- PRODUCTS
- PRODUITS
- PRODUKTEN

- MOBILE CENTRALE CM 80 DISPONIBILE IN FINITURE LEGNI. **COD. 600**
- CENTRAL CABINET 80 CM AVAILABLE IN WOODEN FINISHINGS.
- MUEBLE CENTRAL 80 CM DISPONIBILE EN FINITIONS BOIS.
- ZENTRALSCHRANK VERFÜGBAR IN HOLZBESCHICHTUNGEN, CM 80
- MOBILE CENTRALE CM 120 DISP. IN FINITURE LEGNI. **COD. 601**
- CENTRAL CABINET 120 CM AVAIL. IN WOODEN FINISHINGS.
- MUEBLE CENTRAL 120 CM DISPONIBILE EN FINITIONS BOIS.
- ZENTRALSCHRANK VERFÜGBAR IN HOLZBESCHICHTUNGEN, CM 120.
- MOBILE CENTRALE CM 80 CON LAVABO E MISCEL., DISP. IN FINITURE LEGNI. **COD. 607**
- CENTRAL CABINET 80 CM WITH MIXER AND BASIN, AVAILABLE IN WOODEN FINISHINGS.
- MUEBLE CENTRAL 80 CM AVEC CUVETTE, DISPONIBILE EN FINITIONS BOIS.
- ZENTRALSCHRANK, CM 80, MIT BECKEN UND MISCHBATTERIE, VERFÜGBAR IN HOLZBESCHICHTUNGEN

- MOBILE CENTRALE DA CM 120 CON LAVABO E MISCEL., DISP. IN FINITURE LEGNI. **COD. 608**
- CENTRAL CABINET 120 CM WITH MIXER AND BASIN, AVAILABLE IN WOODEN FINISHINGS.
- MUEBLE CENTRAL 120 CM AVEC CUVETTE DISPONIBILE EN FINITIONS BOIS.
- ZENTRALSCHRANK, CM 120, MIT BECKEN UND MISCHBATTERIE, VERFÜGBAR IN HOLZBESCHICHTUNGEN.

- SPECCHIERA DA CM 80 DISPONIBILE IN FINITURE LEGNI. **COD. 602**
- STYLING UNIT 80 CM AVAILABLE IN WOODEN FINISHINGS.
- COIFFEUSE 80 CM DISPONIBILE EN FINITIONS BOIS.
- SPIEGEL, 80 CM, VERFÜGBAR IN HOLZBESCHICHTUNGEN

- SPECCHIERA DA CM 120 DISPONIBILE IN FINITURE LEGNI. **COD. 603**
- STYLING UNIT 120 CM AVAILABLE IN WOODEN FINISHINGS.
- COIFFEUSE 120 CM DISPONIBILE EN FINITIONS BOIS.
- SPIEGEL, 120 CM, VERFÜGBAR IN HOLZBESCHICHTUNGEN.

- MOBILE A COLONNA CON CASSETTO E ANTA DISPONIBILE IN FIN. LEGNI. **COD. 604**
- COLUMN CABINET WITH DRAWER AND DOOR AVAILABLE IN WOODEN FINISHINGS.
- MEUBLE A COLONNE AVEC TIROIR ET PORTE DISP. EN FINITIONS BOIS.
- SÄULENEINHEIT MIT SCHUBLADE UND TÜR, VERFÜGBAR IN HOLZBESCHICHTUNGEN.
- MOBILE A COLONNA CON VANO GIORNO E ANTA DISP. IN FIN. LEGNI. **COD. 605**
- COLUMN CABINET WITH COMPARTMENT AND DOOR AVAILABLE IN WOODEN FINISHINGS.
- MEUBLE A COLONNE AVEC COMPARTIMENT ET PORTE DISPONIBILE EN FINITIONS BOIS.
- SÄULENEINHEIT MIT GEHÖFFNETES FACH UND TÜR, VERFÜGBAR IN HOLZBESCHICHTUNGEN.
- MENSOLA ESPOSITORE CON PIANI DISPONIBILE IN FINITURE LEGNI. **COD. 606**
- DISPLAY UNIT WITH SHELVES AVAILABLE IN WOODEN FINISHINGS.
- EXPO AVEC ETAGERES DISP. EN FINITIONS BOIS.
- VERKAUFSREGAL VERFÜGBAR IN HOLZBESCHICHTUNGEN.

INSTALLAZIONE / INSTALLATION
INSTALLATION / INSTALLATION

LOHMANN



PAG.214

INSTALLAZIONE / INSTALLATION
INSTALLATION / INSTALLATION

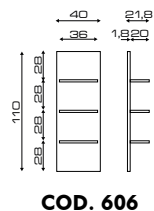

COD. 606

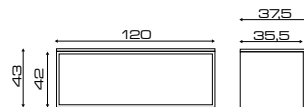

COD. 601

**COD.
M604/3**

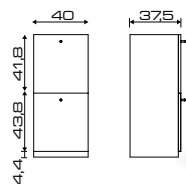

COD. 604



COD. 2X606 + 601 + 604 + 605 + 603 + 2XM604/3 + M601/1

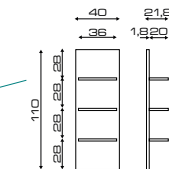

COD. 606

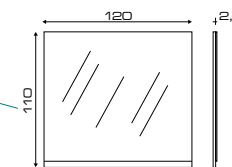

COD. 603

**COD.
M604/3**

**COD.
M601/1**

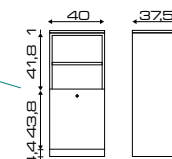

COD. 605

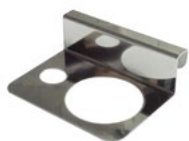

COD. 968



- ACCESSORI
- ACCESSORIES
- ACCESSOIRES
- ZUBEHÖR

- COD. NERO**
- SUPPLEMENTO LAVABO NERO
 - EXTRA CHARGE FOR BLACK BASIN
 - SUPPLEMENT CUVETTE NOIRE
 - ZUSCHLAG FÜR SCHWARZES WASHBECKEN

- COD. M604/3**
- TOP IN SOLID CORE BIANCO PER MOBILE A COLONNA
 - SOLID CORE WHITE TOP FOR COLUMN CABINET
 - TOP EN SOLID CORE BLANC POUR MEUBLE A COLONNE
 - OBERSEITE AUS WEISSEM "SOLID CORE" FÜR SÄULEN MÖBEL

- COD. M600/1**
- TOP IN SOLID CORE BIANCO PER MOBILE DA CM 80
 - SOLID CORE WHITE TOP FOR CABINET 80 CM
 - TOP EN SOLID CORE BLANC POUR MUEBLE 80 CM
 - OBERSEITE AUS WEISSEM "SOLID CORE" FÜR 80 CM

- COD. M601/1**
- TOP IN SOLID CORE BIANCO PER MOBILE DA CM 120
 - SOLID CORE WHITE TOP FOR CABINET 120 CM
 - TOP EN SOLID CORE BLANC POUR MUEBLE 120 CM
 - OBERSEITE AUS WEISSEM "SOLID CORE" FÜR 120 CM

- COD. M607/1**
- TOP IN SOLID CORE BIANCO PER MOBILE DA CM 80 CON LAVABO
 - SOLID CORE WHITE TOP FOR CABINET WITH MIXER AND BASIN 80 CM
 - TOP EN SOLID CORE BLANC POUR MUEBLE 80 CM AVEC CUVETTE
 - OBERSEITE AUS WEISSEM "SOLID CORE" FÜR 80 CM MÖBEL MIT WASHBECKEN

- COD. M608/1**
- TOP IN SOLID CORE BIANCO PER MOBILE DA CM 120 CON LAVABO
 - SOLID CORE WHITE TOP FOR CABINET WITH MIXER AND BASIN 120 CM
 - TOP EN SOLID CORE BLANC POUR MUEBLE 120 CM AVEC CUVETTE
 - OBERSEITE AUS WEISSEM "SOLID CORE" FÜR 120 CM MÖBEL MIT WASHBECKEN

- COD. M600/S**
- TOP IN SOLID CORE BIANCO CONTINUO COSTO AL CENTIMETRO LINEARE
 - SOLID CORE WHITE TOP LINEAR CENTIMETER PRICE
 - TOP IN SOLID CORE BLANC ET NOIR CONTINUE, PRIX AU CENTIMÈTRE LINEAIRE
 - OBERSEITE AUS WEISSEM "SOLID CORE" KOSTEN PRO ZENTIMETER

- COD. 465**
- SUPPLEMENTO PER MISCELATORE TERMOSTATICO CON FORCELLA
 - EXTRA CHARGE FOR THERMOSTATIC MIXER WITH DRIP-PROOF SHOWER
 - SUPPLÉMENT MITIGEUR THERMOSTATIQUE AVEC SYSTÈME ANTI-EGOUTTEMENT
 - MISCHBATTERIE MIT THERMOSTAT UND ANTI-TROPFEN SYSTEM

- COD. 968**
- PORTAPHON
 - BLOW-DRYER HOLDER
 - PORTE-SECHOIR
 - PHÖNHALTER

MAGNUM

INSTALLAZIONE / INSTALLATION
INSTALLATION / INSTALLATION



PAG.214



COD. 847 + F



COD. 847

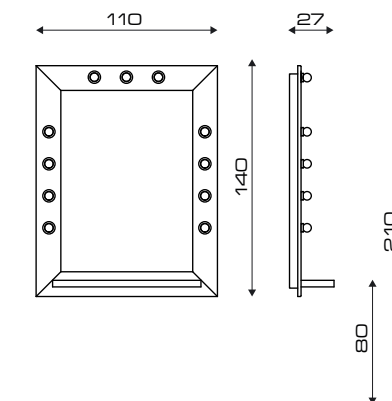

COD. 57
PAG. 167

- PRODOTTI
- PRODUCTS
- PRODUITS
- PRODUKTEN

- PIANETTO
- SHELF
- TABLETTE
- ABLAGE

- ACCESSORI
- ACCESSORIES
- ACCESSOIRES
- ZUBEHÖR



COD. 847

- MENSOLA A PARETE DISPONIBILE IN FINITURE LEGNI, PIANO IN ACCIAIO INOX O FINITURE LEGNO E PORTAPHON.
- WALL STYLING UNIT AVAILABLE IN WOODEN FINISHINGS, SHELF AVAILABLE IN ST. STEEL OR WOOD FINISHING AND HAIRDRAYER HOLDER.
- COIFFEUSE MURALE EN FINITIONS BOIS AU CHOIX, TABLETTE EN ALU POLI OU EN BOIS ET PORTE-SÉCHOIR.
- FRISIERPLATZ VERFÜGBAR IN HOLZBESCHICHTUNGEN MIT ABLAGE AUS EDELSTAHL ODER HOLZ, PHÖNHALTER.



- INOX
- INOX
- ACIER INOX
- EDELSTAHL
- FIN. LEGNI
- WOOD FINISH. SHELF
- FINITION BOIS
- HOLZBESCHICHTUNGEN



COD. ILL

- RETRO ILLUMINAZIONE A LED
- LED BACKLIGHTING
- ILLUMINATION À LED
- LED RÜCKSEITIGE BELEUCHTUNG

COD. F

- LAMPADE LED ANTERIORI TRUCCO
- LED BULBS "MAKE UP"
- PROJÉCTEURS MAKE UP
- "MAKE UP" LED LAMPEN

MAGNUM INOX

INSTALLAZIONE / INSTALLATION
INSTALLATION / INSTALLATION



COD. 8471 + F



COD. 8471

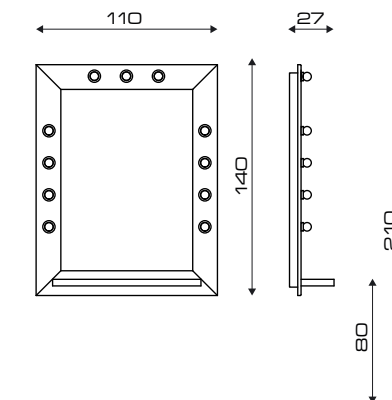

COD. 57
[PAG. 165](#)

- PRODOTTI
- PRODUCTS
- PRODUITS
- TEDESCO

- PIANETTO
- SHELF
- TABLETTE
- ABLAGE

- ACCESSORI
- ACCESSORIES
- ACCESSOIRES
- ZUBEHÖR



COD. 8471

- MENSOLA A PARETE IN ACCIAIO INOX, PIANO IN ACCIAIO INOX CON PORTAPHON.
- WALL STYLING UNIT IN STAINLESS STEEL, ST. STEEL SHELF AND HAIRDRAYER HOLDER
- COIFFEUSE MURALE ACIER INOX, TABLETTE EN ALU POLI ET PORTE-SÉCHOIR.
- FRISIERPLATZ MIT RAHMEN UND ABLAGE AUS EDELSTAHL, PHÖNHALTER



- INOX
- INOX
- ACIER INOX
- EDELSTAHL

COD. ILL

- RETRO ILLUMINAZIONE A LED
- LED BACKLIGHTING
- ILLUMINATION À LED
- LED RÜCKSEITIGE BELEUCHTUNG

COD. F

- LAMPADE LED ANTERIORI TRUCCO
- LED BULBS "MAKE UP"
- PROJÉCTEURS MAKE UP
- "MAKE UP" LED LAMPEN

ICODE



•INTERRUTTORE DIMMER TOUCH PER RETROILLUMINAZIONE
•SWITCH AND DIMMER TOUCH FOR BACKLIGHTING
•INTERRUPTEUR ET VARIATEUR DE LUMIÈRE POUR LE
RÉTRO-ÉCLAIRAGE
•SCHALTER UND DIMMER TOUCH FÜR DIE RÜCKBEL-
LEUCHTUNG



•INTERRUTTORE DIMMER TOUCH ILLUMINAZIONE FRONTALE BASSA
•SWITCH AND DIMMER TOUCH FOR LOW FRONT LIGHTING
•INTERRUPTEUR ET VARIATEUR DE LUMIÈRE POUR POUR L'ÉCLAIRAGE
FRONTAL BAS
•SCHALTER UND DIMMER TOUCH FÜR FÜR NIEDRIGE FRONTALBE-
LEUCHTUNG

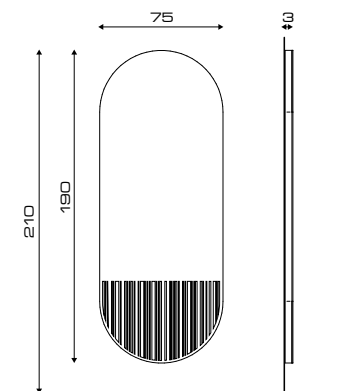

- PRODOTTI
- PRODUCTS
- PRODUITS
- PRODUKTEN



COD. 846

- POSTO LAVORO CON SPECCHIO OVALE, ILLUMINAZIONE LED NELLA PARTE FRONTALE BASSA E RETROILLUMINAZIONE A LED, ENTRAMBE CON INTERRUTTORE E DIMMER TOUCH.
- WALL STYLING UNIT WITH OVAL MIRROR, LED ILLUMINATION IN THE LOW FRONT AND LED BACKLIGHTING, BOTH WITH TOUCH SWITCH AND DIMMER.
- COIFFEUSE AVEC MIROIR OVAL, ILLUMINATION LED DANS LA PARTIE BASSE DE LA FAÇADE ET RÉTRO-ÉCLAIRAGE LED, TOUS DEUX AVEC TOUCH SWITCH ET DIMMER.
- ARBEITSPLATZ MIT OVAL-SPIEGEL, LED-BELEUCHTUNG IN DER UNTEREN FRONT UND LED-HINTERGRUNDBELEUCHTUNG, BEIDES MIT TOUCH-SCHALTER UND DIMMER.

PANDORA

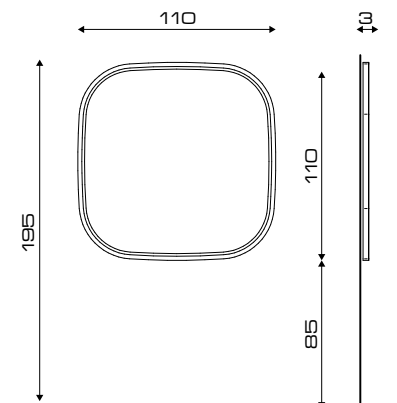

- PRODOTTI
- PRODUCTS
- PRODUITS
- TEDESCO



COD. 851

- SPECCHIERA QUADRATA 110 CM X 110 CM A PARETE CON ILLUMINAZIONE LED, INTERRUTTORE E DIMMER.
- 110 CM X 110 CM SQUARE WALL MIRROR WITH LED ILLUMINATION, SWITCH AND DIMMER.
- MIROIR MURAL CARRÉ DE 110 CM X 110 CM AVEC ILLUMINATION LED, INTERRUPTEUR ET VARIATEUR D'ECLAIRAGE.
- 110 CM X 110 CM QUADRATISCHER WANDSPIEGEL MIT LED-BELEUCHTUNG, SCHALTER UND DIMMER

QUEEN



PAG.214

INSTALLAZIONE / INSTALLATION
INSTALLATION / INSTALLATION

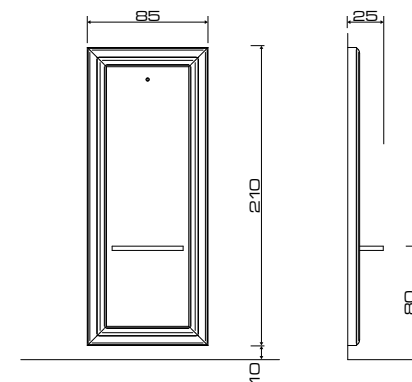

COLORI STANDARD
STANDARD COLORS
COULEURS STANDARD
STANDARD FARBEN



BIANCO OPACO
MATT WHITE
BLANC MAT
MATT WEISS



COD. 901

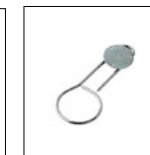

COD. 963

•ACCESSORI
•ACCESSORIES
•ACCESSOIRES
•ZUBEHÖR

•PRODOTTI
•PRODUCTS
•PRODUITS
•PRODUKTEN

•PIANETTO
•SHELF
•TABLETTE
•ABLAGE

COD. ILL

• ILLUMINAZIONE A LED
• LED BACKLIGHTING
• ILLUMINATION À LED
• LED BELEUCHTUNG

COD. FIN

• SUPPLEMENTO COLORE NERO OPACO
• MAT BLACK COLORS PAINTING
• COULEUR SPÉCIALE STRUCTURE NOIR OPAQUE
• ZUSCHLAG FÜR MATT SCHWARZ FARBE

COD. 963

• PORTAPHON A SCOMPARSA
• RETRACTABLE BLOW-DRYER HOLDER
• PORTE-SÉCHOIR EXTRACTIBLE
• EINZIEHBARE PHÖNHALTER

COD. 901

• PORTAPHON SNODABILE CROMATO PER MENSOLA.
• SWIVEL CHROME-PLATED HAIRDRYER HOLDER FOR SHELF.
• PORTE-SÉCHOIR ARTICULÉ CHROMÉ POUR TABLETTE.
• VERCHROMTER GELENK HAARTROCKNERHALTER FÜR FLACHBETT

COD. 959

• POSTO LAVORO CON SPECCHIO BISELLATO, STRUTTURA IN LEGNO VERNICIATA BIANCA, PIANO ACCIAIO, PRAL O FINITURE LEGNI CON PORTAPHON
• WALL STYLING UNIT WITH BEVELLED MIRROR, MATT WHITE PAINTED WOOD STRUCTURE, SHELF AVAILABLE IN ST. STEEL, PRAL OR WOODEN FINISHINGS, WITH DRYER HOLDER
• COIFFEUSE AVEC MIROIR BISEAUTÉ, STRUCTURE EN BOIS PEINT BLANC MAT, TABLETTE ACIER INOX, PRAL OU FINITIONS BOIS, AVEC PORTE-SÉCHOIR
• FRISIERPLATZ MIT RAHMEN AUS MATTWEISSEM HOLZ LACKIERT, ABLAGE AUS EDELSTAHL, PRAL ODER HOLZ OBERFLÄCHEN MIT FÖNHÄLTERUNG



• INOX
• INOX
• ACIER INOX
• EDELSTAHL

• FIN. LEGNI
• WOOD FINISH. SHELF
• FINITION BOIS
• HOLZBESCHICHTUNGEN

• PRAL
• PRAL
• PRAL
• PRAL

SWAG

INSTALLAZIONE / INSTALLATION
INSTALLATION / INSTALLATION

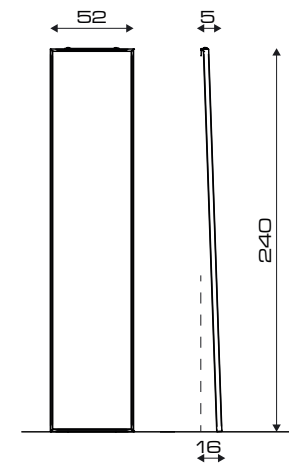

- PRODOTTI
- PRODUCTS
- PRODUITS
- PRODUKTEN



COD. 956

- POSTO LAVORO CORNICE STRUTTURA INOX
- STYLING UNIT WITH STAINLESS STEEL FRAME
- COIFFEUSE MURALE AVEC ENCADREMENT ACIER INOX
- FRISIERPLATZ MIT RAHMEN AUS EDELSTAHL.

TALK

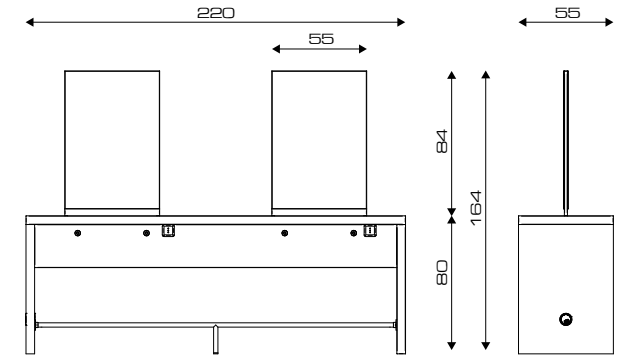

COLORI STANDARD
STANDARD COLORS
COULEURS STANDARD
STANDARD FARBEN

• NERO OPACO
• MATT BLACK
• NOIR MAT
• MATT SCHWARZ



[PAG.214](#)

• PRODOTTI
• PRODUCTS
• PRODUITS
• PRODUKTEN

• ACCESSORI
• ACCESSORIES
• ACCESSOIRES
• ZUBEHÖR



COD. 629

- ISOLA LAVORO 4 POSTI COLORE NERO OPACO.
- MATT BLACK 4 PLACES ISLAND UNIT.
- COIFFEUSE CENTRALE 4 PLACES EN NOIR MAT.
- 4-ER FREISTEHENDER MITTELFRISSIERPLATZ, MATT SCHWARZ.

COD. FIN

- STRUTTURA IN FINITURE LEGNI
- STRUCTURE IN WOOD FINISHES
- STRUCTURE EN FINITIONS BOIS
- STRUKTUR IN HOLZBEREICHEN

TOWER

INSTALLAZIONE / INSTALLATION
INSTALLATION / INSTALLATION

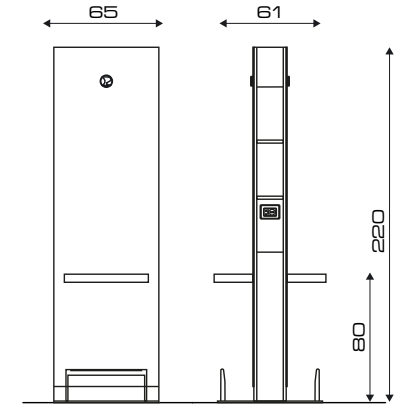

PAG. 214



COD. 963



COD. 901

- PRODOTTI
- PRODUCTS
- PRODUITS
- PRODUKTEN

- PIANETTO
- SHELF
- TABLETTE
- ABLAGE

- ACCESSORI
- ACCESSORIES
- ACCESSOIRES
- ZUBEHÖR

COD. 922



- MENSOLA CENTRALE 2 POSTI STRUTTURA BIANCA, PIANO IN ACCIAIO INOX, PIANETTO PRAL O FINITURE LEGNO, PORTAPHON, POGGIAPIEDI ALLUMINIO.
- DOUBLE ISLAND UNIT WHITE STRUCTURE, ST. STEEL, PRAL OR WOODEN SHELVES, BLOW-DRYER HOLDERS, ALUMINIUM FOOTREST.
- COIFFEUSE CENTRALE A 2 PLACES, STRUCTURE BLANCHE, TABLETTE EN ACIER INOX, PRAL OU BOIS, PORTE-SECHOIR, REPOSE-PIEDS ALUMINIUM POLI.
- 2-ER FREISTEHENDER MITTELFRISSERPLATZ MIT ABLAGE AUS EDELSTAHL, PRAL ODER HOLZ. PHÖHALTER.



- INOX
- INOX
- ACIER INOX
- EDELSTAHL



- FIN. LEGNI
- WOOD FINISH. SHELF
- FINITION BOIS
- HOLZBESCHICHTUNGEN



- PRAL
- PRAL
- PRAL
- PRAL

COD. 963

- PORTAPHON A SCOMPARSA
- RETRACTABLE BLOW-DRYER HOLDER
- PORTE-SECHOIR EXTRACTIBLE
- EINZIEHBARE PHÖNHALTER

COD. 901

- PORTAPHON SNODABILE CROMATO PER MENSOLA.
- SWIVEL CHROME-PLATED HAIRDRYER HOLDER FOR SHELF.
- PORTE-SECHOIR ARTICULÉ CHROMÉ POUR TABLETTE.
- VERCHROMTER GELENKHAARTROCKNERHALTER FÜR FLACHBETT

COD. V

- SUPPLEMENTO SERVICES LATERALI
- COUPLE OF LATERAL SERVICES
- SUPPLÉMENT 2 RANGEMENTS LATÉRAUX
- ZUSCHLAG FÜR SEITLICHEN ABLAGEFLÄCHEN

VISIONHAIR

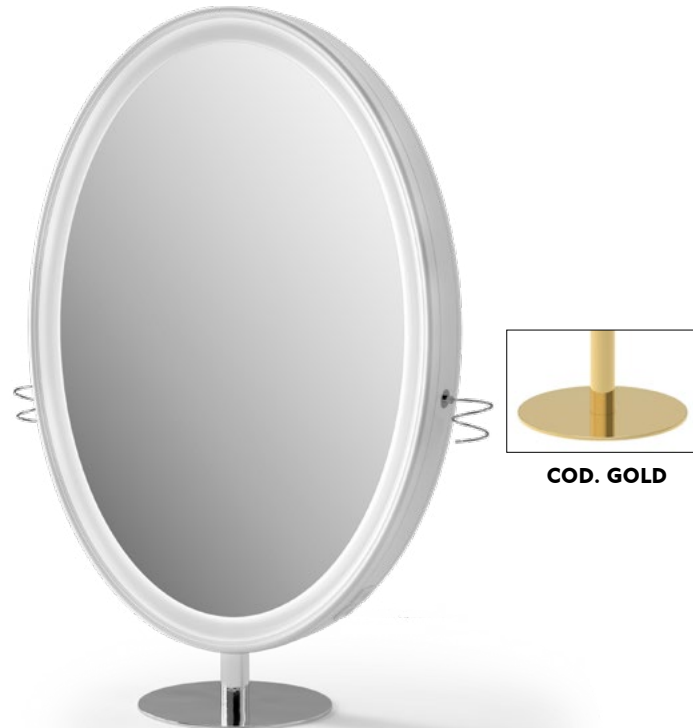

COD. GOLD

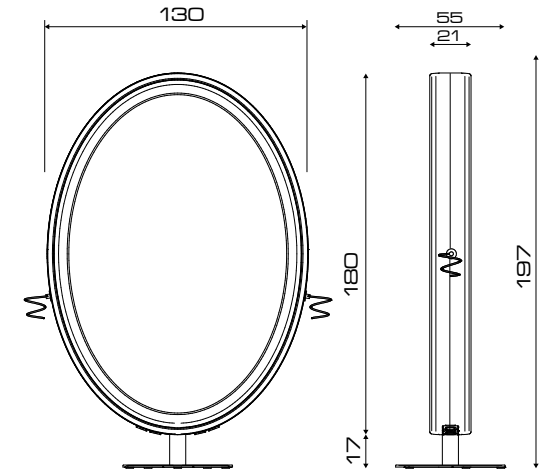

- COLORI STANDARD
- STANDARD COLORS
- COULEURS STANDARD
- STANDARD FARBEN



- BIANCO OPACO
- MATT WHITE
- BLANC MAT
- MATT WEISS



COD. 130



COD. 130G

- PRODOTTI
- PRODUCTS
- PRODUITS
- PRODUKTEN

- ACCESSORI
- ACCESSORIES
- ACCESSOIRES
- ZUBEHÖR



COD. 960

- POSTO LAVORO CENTRALE STR.VERNICIATA BIANCA, PARTI IN METALLO CROMATE.
- 2-PLACE ISLAND, MATT WHITE PAINTED WOOD STRUCTURE, DETAILS IN CHROMED METAL.
- COIFFEUSE CENTRALE 2 PLACES, STRUCTURE EN BOIS, PEINT BLANC MAT, DÉTAILS EN MÉTAL CHROMÉ.
- FRISIERPLATZ FREESTANDING 2 PLÄTZE, STRUKTUR WEISS LACKIERT, TEILE AUS VERCHROMTEM METALL.

COD. 130

- PORTA FON CROMATO (2 PEZZI).
- CHROMED DRYERHOLDER (2 PIECES).
- PORTE-SÉCHOIR CHROMÉ (2 PIÈCES).
- VERCHROMTEN FÖNHALTERUNG (2 STÜCKE).

COD. 130G

- PORTA FON CROMATO ORO (2 PEZZI).
- GOLD CHROMED DRYERHOLDER (2 PIECES).
- PORTE-SÉCHOIR CHROMÉ OR (2 PIÈCES).
- VERCHROMTEN GOLD FÖNHALTERUNG (2 STÜCKE).

COD. ILL

- ILLUMINAZIONE A LED.
- LED BACKLIGHTING.
- ILLUMINATION À LED.
- LED BELEUCHTUNG.

COD. P010

- SUPPLEMENTO PIEDE COLORE ORO.
- EXTRA CHARGE FOR GOLD PAINTED BASE.
- SUPPLEMENT PEINTURE PIED COULEUR OR.
- ZUSCHLAG FÜR GOLD VERSION FUSS (FÜR INSELL).

COD. FIN

- SUPPLEMENTO COLORE NERO OPACO PER CORNICE.
- MAT BLACK FRAME COLORS PAINTING.
- COULEUR SPÉCIALE STRUCTURE MET NOIR.
- ZUSCHLAG FÜR MATT SCHWARZ FARBE.

VISIONHAIR PARETE

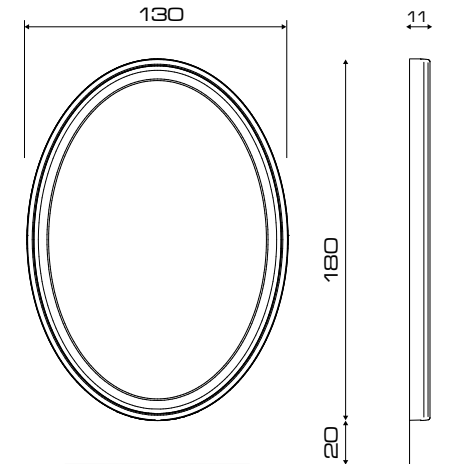

- COLORI STANDARD
- STANDARD COLORS
- COULEURS STANDARD
- STANDARD FARBEN



- BIANCO OPACO
- MATT WHITE
- BLANC MAT
- MATT WEISS



COD. 130



COD. 130G

- PRODOTTI
- PRODUCTS
- PRODUITS
- PRODUKTEN

- ACCESSORI
- ACCESSORIES
- ACCESSOIRES
- ZUBEHÖR

COD. 130

- PORTA PHON CROMATO (1 PEZZO).
- CROMED DRYERHOLDER (1 PIECE).
- PORTE-SÉCHOIR CHROMÉ (1 PIÈCE).
- VERCHROMTEN FÖNHALTERUNG (1 STÜCK).

COD. 130G

- PORTA PHON CROMATO ORO (1 PEZZO).
- GOLD CROMED DRYERHOLDER (1 PIECE).
- PORTE-SÉCHOIR CHROMÉ OR (1 PIÈCE).
- VERCHROMTEN GOLD FÖNHALTERUNG (1 STÜCK).

COD. FIN

- SUPPLEMENTO COLORE NERO OPACO PER CORNICE
- MAT BLACK FRAME COLORS PAINTING
- COULEUR SPÉCIALE STRUCTURE MET NOIR
- ZUSCHLAG FÜR MATT SCHWARZ FARBE

COD. ILL

- ILLUMINAZIONE A LED
- LED BACKLIGHTING
- ILLUMINATION À LED
- LED BELEUCHTUNG



COD. 961

- MENSOLA A PARETE CON STRUTTURA VERNICIATA BIANCO OPACO.
- WALL STYLING UNIT, MATT WHITE PAINTED WOOD STRUCTURE.
- COIFFEUSE MURALE, STRUCTURE EN BOIS PEINT BLANC MAT.
- FRISIERPLATZ, STRUKTUR WEISS LACKIERT.

VEIL



PAG.214



INSTALLAZIONE / INSTALLATION
INSTALLATION / INSTALLATION

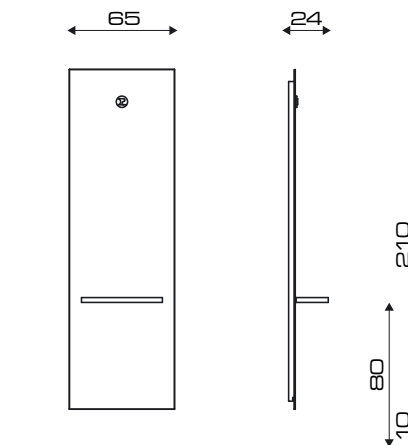

- PRODOTTI
- PRODUCTS
- PRODUITS
- PRODUKTEN

- PIANETTO
- SHELF
- TABLETTE
- ABLAGE

- ACCESSORI
- ACCESSORIES
- ACCESSOIRES
- ZUBEHÖR



COD. 930

- MENSOLA A PARETE, PIANETTO IN ACCIAIO INOX, PRAL O FINITURE LEGNI CON PORTAPHON
- WALL STYLING UNIT, SHELF AVAILABLE IN ST. STEEL, PRAL OR WOODEN FINISHING, WITH DRYER HOLDER
- COIFFEUSE MURALE, TABLETTE ACIER INOX, PRAL OU FINITIONS BOIS, AVEC PORTE-SECHOIR
- FRISIERPLATZ, ABLAGE AUS EDELSTAHL, PRAL ODER HOLZBEREICHEN MIT FÖNHÄLTERUNG



- INOX
- INOX
- ACIER INOX
- EDELSTAHL



- FIN. LEGNI
- WOOD FINISH. SHELF
- FINITION BOIS
- HOLZBESCHICHTUNGEN



- PRAL
- PRAL
- PRAL
- PRAL

COD. ILL

- ILLUMINAZIONE A LED
- LED BACKLIGHTING
- ILLUMINATION A LED
- LED BELEUCHTUNG

COD. 963

- PORTAPHON A SCOMPARSA
- RETRACTABLE BLOW-DRYER HOLDER
- PORTE-SECHOIR EXTRACTIBLE
- EINZIEHBARE PHÖNHÄLTER

MALIBÙ

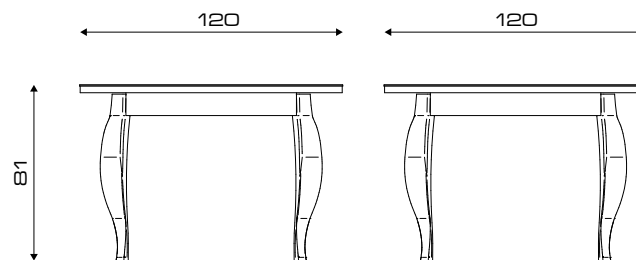

PRODOTTI
PRODUCTS
PRODUITS
PRODUKTEN

COD. 852

- TAVOLO DA LAVORO 4 POSTI ROTONDO, DIAMETRO 120 CM, STRUTTURA TAVOLO LACCATO BIANCO O NERO CON PIANO IN VETRO VERNICIATO DISPONIBILE IN COLORE MARMO BIANCO, MARMO BLU O MARMO NERO.
- 4-SEATER ROUND WORK TABLE, DIAMETER 120 CM, WHITE OR BLACK LACQUERED TABLE FRAME WITH PAINTED GLASS TOP AVAILABLE IN WHITE MARBLE, BLUE MARBLE OR BLACK MARBLE.
- TABLE DE TRAVAIL RONDE 4 PLACES, DIAMÈTRE 120 CM, STRUCTURE LAQUÉE BLANCHE OU NOIRE AVEC PLATEAU EN VERRE PEINT DISPONIBLE EN MARBRE BLANC, MARBRE BLEU OU MARBRE NOIR.
- 4-SITZIGER RUNDER ARBEITSTISCH, 120 CM DURCHMESSER, MIT LACKIERTER GLASPLATTE WEISS ODER SCHWARZ LACKIERTES TISCHGESTELL, GLASPLATTE AUS WEISSEM, BLAUEM ODER SCHWARZEM MARMOR EFFEKT



- VERSIONI
- MODELS
- VERSIONS
- VERSIONEN

- STRUTTURA BIANCA, PIANO VERNICIATO MARMO BIANCO
• WHITE FRAME, TOP PAINTED WHITE MARBLE
• STRUCTURE BLANCHE, PARTIE SUPÉRIEURE PEINTE EN MARBRE BLANC
• WEISSER RAHMEN, PLATTE AUS WEISSEM MARMOR
- STRUTTURA BIANCA, PIANO VERNICIATO MARMO NERO
• WHITE FRAME, TOP PAINTED BLACK MARBLE
• STRUCTURE BLANC, PARTIE SUPÉRIEURE PEINTE EN MARBRE NOIR
• WEISSER RAHMEN, PLATTE AUS SCHWARZEM MARMOR.
- 3. STRUTTURA BIANCA, PIANO VERNICIATO MARMO BLU
• WHITE FRAME, TOP PAINTED BLUE MARBLE
• STRUCTURE BLANC, PARTIE SUPÉRIEURE PEINTE EN MARBRE BLEU
• WEISSER RAHMEN, PLATTE AUS BLAUER MARMOR.
- STRUTTURA NERA, PIANO VERNICIATO MARMO BIANCO.
• BLACK FRAME, TOP PAINTED WHITE MARBLE.
• STRUCTURE NOIRE, PARTIE SUPÉRIEURE PEINTE EN MARBRE BLANC.
• SCHWARZE RAHMEN, PLATTE AUS WEISSEM MARMOR.
- STRUTTURA NERA, PIANO VERNICIATO MARMO NERO.
• BLACK FRAME, TOP PAINTED BLACK MARBLE.
• STRUCTURE NOIRE, PARTIE SUPÉRIEURE PEINTE EN MARBRE NOIR.
• SCHWARZE RAHMEN, PLATTE AUS SCHWARZEM MARMOR.
- STRUTTURA NERA, PIANO VERNICIATO MARMO BLU.
• BLACK FRAME, TOP PAINTED BLUE MARBLE.
• STRUCTURE NOIRE, PARTIE SUPÉRIEURE PEINTE EN MARBRE BLEU.
• SCHWARZE RAHMEN, PLATTE AUS BLAUER MARMOR.

CASSE RECEPTION CASHDESKS MEUBLES CAISSE REZEPTION-KASSE

IT CON PIETRANERA, ANCHE IL MOBILE CASSA DIVENTA UN ELEMENTO FONDAMENTALE, IN LINEA CON L'ARREDAMENTO DELL'INTERO SALONE. DAL LOOK MINIMAL AL TOCCO GLAM, PUOI SCEGLIERE LO STILE CHE PIÙ TI SODDISFA, SENZA TRALASCIARE NESSUN DETTAGLIO.

EN PIETRANERA TURNS THE CASH DESK INTO A FUNDAMENTAL COMPONENT THAT MATCHES THE FURNISHINGS OF THE ENTIRE SALON. FROM MINIMAL LOOKS TO A TOUCH OF GLAM, CHOOSE THE STYLE YOU LIKE BEST WITHOUT NEGLECTING EVEN THE TINIEST DETAIL.

FR AVEC PIETRANERA, MÊME LE MEUBLE CAISSE DEVIENT UN ÉLÉMENT FONDAMENTAL, EN LIGNE AVEC L'AMEUBLEMENT DE TOUT LE SALON. DÉPUIS LE LOOK MINIMAL À LA TOUCHE GLAM, VOUS POUVEZ CHOISIR LE STYLE QUI VOUS SATISFAIT LE PLUS, SANS NÉGLIGER AUCUN DÉTAIL.

DE MIT PIETRANERA WIRD AUCH DAS KASSEN MÖBEL ZU EINEM WESENTLICHEN ELEMENT, IN LINIE MIT DER EINRICHTUNG DES GESAMTEN SALONS. VOM MINIMAL-LOOK ZUM TOUCH VON GLAMOUR, SIE KÖNNEN IHREN GEWÜNSCHTEN STIL WÄHLEN OHNE DABEI AUF KEIN DETAIL VERZICHTEN ZU MÜSSEN.





BIG PARTY

BIG PARTY IMAGE



COD. 656N.L



COD. 656N.LI

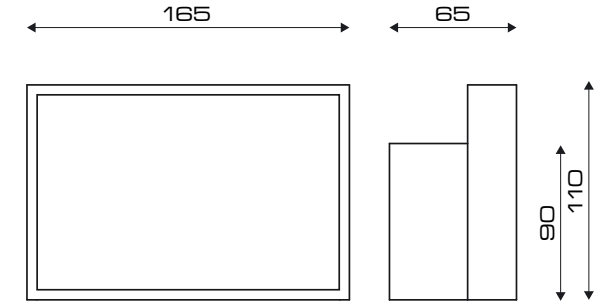

[PAG.214](#)



- COLORE STANDARD PER PONTE
- STANDARD FRAME COLOR
- COULEUR STANDARD ENCADREMENT
- RAHMEN STANDARD FARBE

- NERO LUCIDO
- GLOSSY BLACK
- NOIR BRILLANT
- GLÄNZEND SCHWARZ



[PAG.212 -213](#)

- PRODOTTI
- PRODUCTS
- PRODUITS
- PRODUKTEN

- ACCESSORI
- ACCESSORIES
- ACCESSOIRES
- ZUBEHÖR



COD. 656N.L

- STRUTTURA BIANCA, PONTE NERO LUCIDO, FRONTALE IN METACRILATO CON LED.
- WHITE CABINET, GLOSS BLACK FRAME, METACRYLATE FRONT, WITH LED LIGHTING.
- STRUCTURE BLANCHE, ENCADREMENT NOIR BRILLANT, PANNEAU FRONTAL METHACRYLATE AVEC ÉCLAIRAGE LED.
- WEISS STRUKTUR, GLANZ SCHWARZ RAHMEN, VORDERSEITE AUS METHACRYLAT MIT LED.



COD. 656N.LI

- STRUTTURA BIANCA, PONTE NERO LUCIDO CON IMMAGINE SOSTITUIBILE E RETROILLUMINAZIONE A LED.
- WHITE CABINET, GLOSS BLACK FRAME, METACRYLATE FRONT WITH REPLACEABLE PICTURE AND LED BACKLIGHTING.
- STRUCTURE BLANCHE, AVEC ENCADREMENT NOIR BRILLANT ET IMAGE REMPLAÇABLE RÉTROÉCLAIRÉ A LED.
- WEISS STRUKTUR, GLANZ SCHWARZ RAHMEN, VORDERSEITE MIT AUSTAUSCHBARES BILD UND LED BELEUCHTET.

COD. 751

- IMMAGINE DI RICAMBIO PER COD. 656N.LI
- REPLACEABLE PICTURE FOR COD. 656N.LI
- IMAGE REMPLAÇABLE POUR COD. 656N.LI
- ERSATZBILD FÜR COD. 656N.LI

COD. SPEC.

- PONTE IN COLORE SPECIALE
- SPECIAL FRAME COLOUR
- ENCADREMENT EN COULEUR SPECIAL
- RAHMEN IN SPEZIELLER FARBE

BRICK

BRICK IMAGE

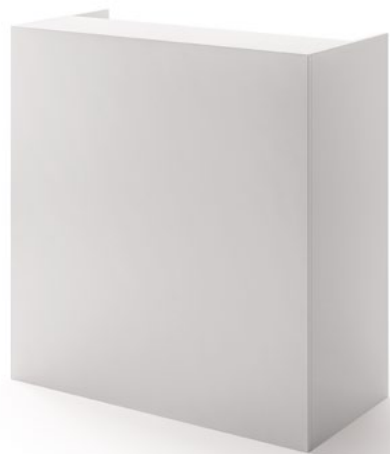

COD. 690



COD. 690I

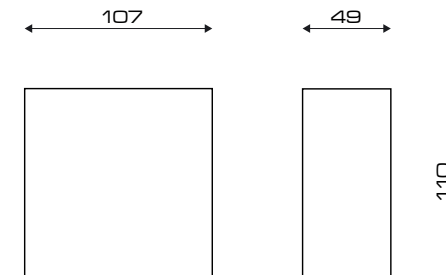

[PAG.214](#)



[PAG.212 -213](#)

- PRODOTTI
- PRODUCTS
- PRODUITS
- PRODUKTEN

- ACCESSORI
- ACCESSORIES
- ACCESSOIRES
- ZUBEHÖR



COD. 690

- CASSA DISPONIBILE IN FINITURE LEGNI.
- RECEPTION DESK AVAILABLE IN WOODEN FINISHINGS.
- CAISSE DISPONIBLE EN FINITIONS BOIS AU CHOIX.
- RECEPTION VERFÜGBAR IN HOLZBESCHICHTUNGEN.



COD. 690I

- CASSA DISPONIBILE IN FINITURE LEGNI, CON IMMAGINE SOSTITUIBILE.
- RECEPTION DESK AVAILABLE IN WOODEN FINISHINGS AND REPLACEABLE IMAGE.
- CAISSE DISPONIBLE EN FINITIONS BOIS AU CHOIX ET IMAGE REMPLACABLE.
- RECEPTION VERFÜGBAR IN HOLZBESCHICHTUNGEN, MIT AUSTAUSCHBARES BILD.

COD. F690I

- IMMAGINE DI RICAMBIO PER COD. 656N.LI
- REPLACEABLE PICTURE FOR COD. 656N.LI
- IMAGE REMPLAÇABLE POUR COD. 656N.LI
- ERSATZBILD FÜR COD. 656N.LI

DOMINO

- COLORI STANDARD PER FRONTALE
- FRONTAL STANDARD COLORS
- COULEURS STANDARD FRONTAL
- STANDARD FARBEN FÜR DIE FRONT

- NERO LUCIDO
- GLOSSY BLACK
- NOIR BRILLANT
- GLÄNZEND SCHWARZ

- BIANCO LUCIDO
- GLOSS WHITE
- BLANC BRILLANT
- GLÄNZEND WEISS

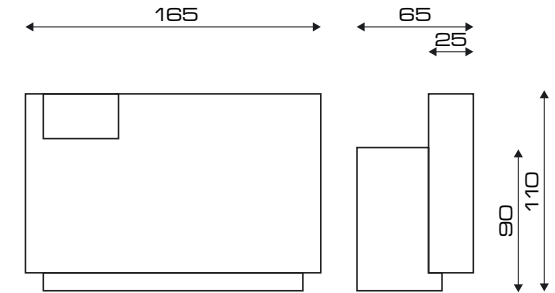

- PRODOTTI
- PRODUCTS
- PRODUITS
- PRODUKTEN



COD. 669N.L

- STRUTTURA BIANCA, FRONTALE NERO LUCIDO, TECA E ZOCCOLO ILLUMINATI A LED.
- WHITE CABINET, GLOSS BLACK FRONT WITH LED LIGHTING.
- STRUCTURE BLANCHE, ENCAD. NOIR BRILLANT, VITRINE, SOCLE AVEC ÉCLAIRAGE LED.
- WEISS STRUKTUR, GLANZ SCHWARZ VORDERSEITE, VERKAUFVITRINE UN SOCKEL LED BELEUCHTET.



COD. 669B.L

- STRUTTURA BIANCA, FRONTALE BIANCO LUCIDO, TECA E ZOCCOLO ILLUMINATI A LED.
- WHITE CABINET, GLOSS WHITE FRONT WITH LED LIGHTING.
- STRUCTURE BLANCHE, ENCADR. BLANC BRILLANT, VITRINE ET SOCLE AVEC ÉCLAIRAGE LED.
- WEISS STRUKTUR, GLANZ WEISS VORDERSEITE, VERKAUFVITRINE UN SOCKEL LED BELEUCHTET.

ONE

INSTALLAZIONE / INSTALLATION
INSTALLATION / INSTALLATION

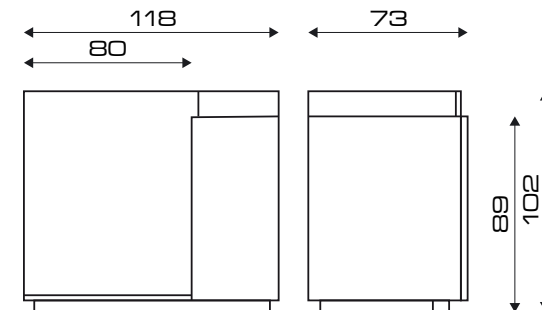

[PAG.214](#)

- PRODOTTI
- PRODUCTS
- PRODUITS
- PRODUKTEN



COD. 666B

- CASSA CON STRUTTURA MOBILE BIANCO LUCIDO, FRONTALE DISPONIBILE IN FINITURE LEGNI.
- RECEPTION-DESK WITH GLOSS WHITE STRUCTURE, FRONT PANEL AVAILABLE IN WOODEN FINISHING.
- CAISSE AVEC MEUBLE BLANC BRILLANT, PANNEAU FRONTAL DISPONIBLE EN FINITIONS BOIS AU CHOIX.
- GLANZ WEISS STRUKTUR, VORDERSEITE VERFÜGBAR IN HOLZBESCHICHTUNGEN.

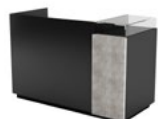

COD. 666N

- CASSA CON STRUTTURA MOBILE NERO LUCIDO, FRONTALE DISPONIBILE IN FINITURE LEGNI.
- RECEPTION-DESK WITH GLOSS BLACK STRUCTURE, FRONT PANEL AVAILABLE IN WOODEN FINISHING.
- CAISSE AVEC MEUBLE NOIR BRILLANT, PANNEAU FRONTAL DISPONIBLE EN FINITIONS BOIS AU CHOIX.
- GLANZ SCHWARZ STRUKTUR, VORDERSEITE VERFÜGBAR IN HOLZBESCHICHTUNGEN.

PARTY

PARTY IMAGE

INSTALLAZIONE / INSTALLATION
INSTALLATION / INSTALLATION

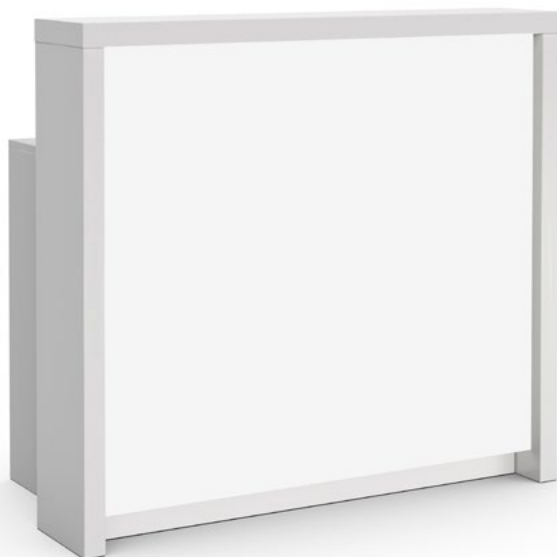

COD. 657B.L



COD. 657N.LI

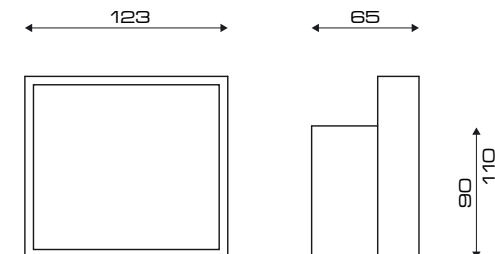

- PRODOTTI
- PRODUCTS
- PRODUITS
- PRODUKTEN

- COLORE STANDARD PER PONTE
- STANDARD FRAME COLOR
- COULEUR STANDARD ENCADREMENT
- RAHMEN STANDARD FARBE



- BIANCO OPACO
- MATT WHITE
- BLANC MAT
- MATT WEISS



- NERO LUCIDO
- GLOSSY BLACK
- NOIR BRILLANT
- GLÄNZEND SCHWARZ

- ACCESSORI
- ACCESSORIES
- ACCESSOIRES
- ZUBEHÖR

[PAG.212 -213](#)



COD. 657N.L

- STRUTTURA BIANCA, PONTE NERO LUCIDO, FRONTALE IN METACRILATO CON LED.
- WHITE CABINET, GLOSS BLACK FRAME, METACRYLATE FRONT, WITH LED LIGHTING.
- STRUC. BLANCHE, ENCADR. NOIR BRILLANT, PANNEAU METHACR. AVEC ÉCLAIRAGE LED
- WEISS STRUKTUR, GLANZ SCHWARZ RAHMEN, VORDERSEITE AUS METHACRYLAT MIT LED.



COD. 657N.LI

- STRUTTURA BIANCA, PONTE NERO LUCIDO, FRONTALE CON IMMAGINE SOSTITUIBILE E RETROILLUMINAZIONE LED.
- WHITE CABINET, GLOSS BLACK FRAME, WITH REPLACEABLE PICTURE AND LED BACKLIGHTING.
- STRUCT. BLANCHE, ENCADREMENT NOIR BRILLANT ET IMAGE REMPLAÇABLE RÉTROÉCLAIRÉ A LED.
- WEISS STRUKTUR, GLANZ SCHWARZ RAHMEN, VORDERSEITE MIT AUSTAUSSCHBARES BILD UND LED BELEUCHTET.



COD. 657B.L

- STRUTTURA BIANCA, PONTE BIANCO OPACO, FRONTALE IN METACRILATO CON LED.
- WHITE CABINET, MATT WHITE FRAME, METACRYLATE FRONT, WITH LED LIGHTING.
- STRUC. BLANCHE, ENCADR. BLANC MAT, PANNEAU METHACR. AVEC ÉCLAIRAGE LED.
- WEISS STRUKTUR, MATT WEISS RAHMEN, VORDERSEITE AUS METHACRYLAT MIT LED.



COD. 657B.LI

- STRUTTURA BIANCA, PONTE BIANCO OPACO FRONTALE, CON IMMAGINE SOSTITUIBILE E RETROILLUMINAZIONE LED.
- WHITE CABINET, MATT WHITE FRAME, WITH REPLACEABLE PICTURE LED BACKLIGHTING.
- STRUCTURE BLANCHE, ENCADREMENT BLANC MAT ET IMAGE REMPLAÇABLE RÉTROÉCLAIRÉ A LED.
- WEISS STRUKTUR, MATT WEISS RAHMEN, VORDERSEITE MIT AUSTAUSSCHBARES BILD UND LED BELEUCHTET.

COD. P.SPECIALE

- PONTE IN COLORE SPECIALE
- SPECIAL FRAME COLOUR
- ENCADREMENT EN COULEURSPECIAL
- RAHMEN IN SPEZIELLER FARBE

COD. 750

- IMMAGINE DI RICAMBIO PER COD. 657N.LI, 657N.LI
- REPLACEABLE PICTURE FOR COD. 657N.LI, 657N.LI
- IMAGE REMPLAÇABLE POUR COD. 657N.LI, 657N.LI
- ERSATZBILD FÜR COD. 657N.LI, 657N.LI

PRISMA



PAG.214

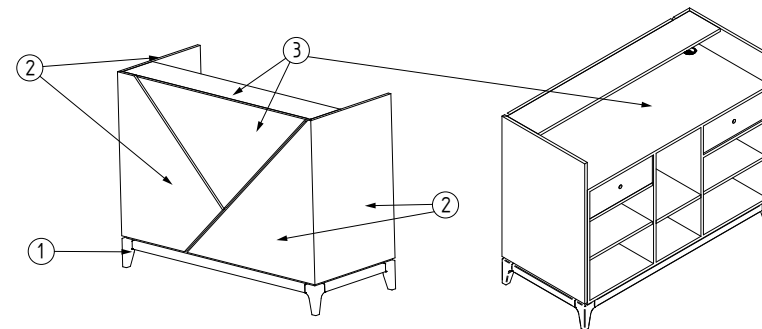
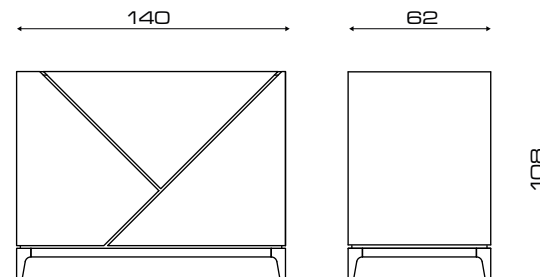

- 1 • FINITURA BASE VERNICIATA IN COLORE FRASSINO NATURALE.
• PAINTED BASE FINISHING COLOUR IN NATURAL ASH-WOOD.
• FINITIONS DE LA BASE VERNI EN COLOUER FRÊNE NATURAL.
• ENDBEARBEITUNG LACKIERTE BASIS, IN NATÜRLICHE ESCHÉ FARBE.
- 2 • TUTTE LE FINITURE LEGNI.
• ALL WOODEN FINISHING.
• TOUTES LES FINITIONS DE BOIS.
• ALLE DIE HOLZBESCHICHTUNGEN.
- 3 • TUTTE LE FINITURE LEGNI TRANNE BIANCO LUCIDO E NERO LUCIDO.
• ALL WOODEN FINISHING EXCEPT GLOSS WHITE AND GLOSS BLACK .
• TOUTES LES FINITIONS DE BOIS A L'EXCEPTION DU BLANC BRILLANT ET NOIR BRILLANT.
• ALLE DIE HOLZBEARBEITUNGEN, AUSSER GLÄNZEND SCHWARZ UND WEISS.

- PRODOTTI
- PRODUCTS
- PRODUITS
- PRODUKTEN

- ACCESSORI
- ACCESSORIES
- ACCESSOIRES
- ZUBEHÖR



COD. 646

- MOBILE DISPONIBILE IN FINITURE LEGNO (ESCLUSO BIANCO LUCIDO E NERO LUCIDO) SCUDO DISPONIBILE IN TUTTE LE FINITURE LEGNO.
- STRUCTURE AVAILABLE IN WOODEN FINISHING (EXCEPT GLOSS WHITE AND GLOSS BLACK) SHIELD AVAILABLE IN ALL WOODEN FINISHING.
- STRUCTURE DISPONIBILE EN FINITIONS BOIS (SAUF BLANC BRILLANT ET NOIR BRILLANT), BOUCLIER DISPONIBILE EN TOUTES LES FINITIONS BOIS.
- STRUKTUR AUS HOLZ-ENDBEARBEITUNGEN VERFUGBAR (AUSSER GLANZ WEISS ODER GLANZ SCHWARZ) SCHILD AUS ALLEN HOLZ-ENDBEARBEITUNGEN VERFUGBAR.

COD. LED

- ILLUMINAZIONE A LED
- LED BACKLIGHTING
- ILLUMINATION A LED
- LED BELEUCHTUNG

TEKA

INSTALLAZIONE / INSTALLATION
INSTALLATION / INSTALLATION

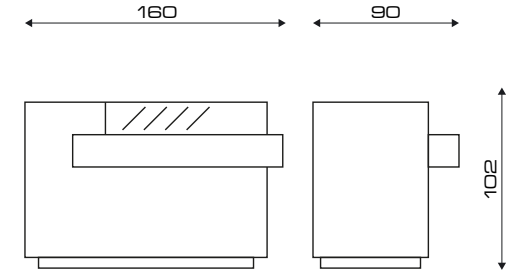

- COLORI STANDARD
- STANDARD COLORS
- COULEURS STANDARD
- STANDARD FARBEN



- NERO LUCIDO
- GLOSSY BLACK
- NOIR BRILLANT
- GLÄNZEND SCHWARZ



- BIANCO LUCIDO
- GLOSS WHITE
- BLANC BRILLANT
- GLANZED WEISS

- PRODOTTI
- PRODUCTS
- PRODUITS
- PRODUKTEN

COD. 665N

- STRUTTURA MOBILE NERO LUCIDO, PIANO TECA DISPONIBILE IN FINITURE LEGNI
- GLOSS BLACK STRUCTURE, SHOP-WINDOW BASE AVAILABLE IN WOODEN FINISHING
- STRUCTURE NOIR BRILLANT, BASE DE LA VITRINE DISPONIBLE EN FINITIONS BOIS
- GLANZ SCHWARZ STRUKTUR, VERKAUFSVITRINE BASIS AUS HOLZ-ENDBEARBEITUNGEN VERFUGBAR



COD. 665B

- STRUTTURA MOBILE BIANCO LUCIDO, PIANO TECA DISPONIBILE IN FINITURE LEGNI
- GLOSS WHITE STRUCTURE, SHOP-WINDOW BASE AVAILABLE IN WOODEN FINISHING
- STRUCTURE BLANC BRILLANT, BASE DE LA VITRINE DISPONIBLE EN FINITIONS BOIS
- GLANZ WEISS STRUKTUR, VERKAUFSVITRINE BASIS AUS HOLZ-ENDBEARBEITUNGEN VERFUGBAR



WONDER

NEWS



COD. 647N

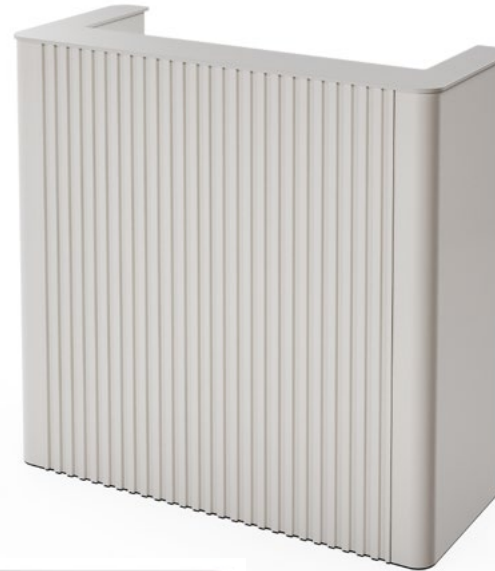

COD. 647B



INSTALLAZIONE / INSTALLATION
INSTALLATION / INSTALLATION

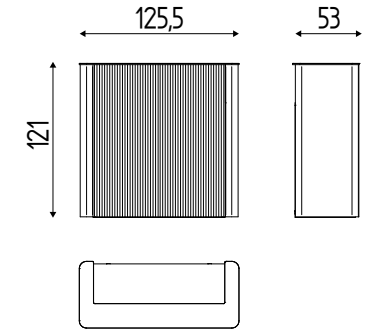

- PRODOTTI
- PRODUCTS
- PRODUITS
- PRODUKTEN



COD. 647N

- CASSA CON MOBILE BIANCO OPACO, PONTE E FRONTALE LACCATO NERO OPACO, PIANO IN SOLID CORE NERO OPACO
- RECEPTION-DESK WITH MATT WHITE STRUCTURE, MATT BLACK LACQUERED FRAME AND FRONT PANEL, MATT BLACK SOLID CORE TOP
- CAISSE AVEC MEUBLE BLANC MAT, PANNEAU FRONTAL ET ENCADREMENT LAQUÉS NOIR MAT, PLAN SUPÉRIEUR EN SOLID CORE NOIR MAT
- REZEPTION-KASSE MIT MATT WEISS STRUKTUR, MATT SCHWARZ RAHMEN UND VORDERSEITE, MATT SCHWARZ OBERTEIL AUS SOLID CORE



COD. 647B

- CASSA CON MOBILE BIANCO OPACO, PONTE E FRONTALE LACCATO BIANCO OPACO, PIANO IN SOLID CORE BIANCO OPACO
- RECEPTION-DESK WITH MATT WHITE STRUCTURE, MATT WHITE LACQUERED FRAME AND FRONT PANEL, MATT WHITE SOLID CORE TOP
- CAISSE AVEC MEUBLE BLANC MAT, PANNEAU FRONTAL ET ENCADREMENT LAQUÉS BLANC MAT, PLAN SUPÉRIEUR EN SOLID CORE BLANC MAT
- REZEPTION-KASSE MIT MATT WEISS STRUKTUR, MATT WEISS RAHMEN UND VORDERSEITE, MATT WEISS OBERTEIL AUS SOLID CORE

TAVOLO DISABILI

- TABLE FOR PEOPLE WITH DISABILITIES
- TABLE POUR PMR
- TISCH FÜR BEHINDERTE

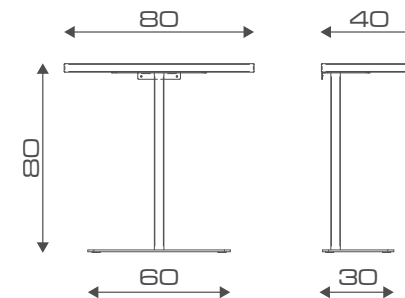

- PRODOTTI
- PRODUCTS
- PRODUITS
- PRODUKTEN



COD. 990

- TAVOLINO PER DISABILI IN FINITURE LEGNI
- TABLE FOR DISABLED PEOPLE AVAILABLE IN WOODEN FINISHINGS
- TABLE POUR PMR DISPONIBLE EN FINITIONS BOIS AU CHOIX
- TISCH FÜR BEHINDERTE AUS HOLZ-ENDBEARBEITUNGEN VERFUGBAR.



COMPLEMENTI COMPLEMENTS COMPLEMENTS EINRICHTUNGSGEGENSTÄNDE

IT CLASSE, FASCINO, PERSONALITÀ, ORIGINALITÀ, COMUNICA CIÒ CHE VUOI CON GLI ESPOSITORI E LE STRUTTURE PER LA COMUNICAZIONE PIETRANERA. NON SOLO, PUOI USARLE PER DIVIDERE GLI AMBIENTI E PERSONALIZZARE IL TUO SALONE DANDOGLI IL VOLTO CHE TI PIACE DI PIÙ.

EN STYLE, ALLURE, PERSONALITY, ORIGINALITY. GET YOUR MESSAGE OVER USING PIETRANERA COMMUNICATION STRUCTURES AND DISPLAYS, AND THAT'S NOT ALL: YOU CAN USE THEM TO PARTITION OFF ROOM AREAS OR TO CUSTOMIZE YOUR SALON WITH THE LOOK YOU LIKE BEST.

FR CLASSE, CHARME, PERSONNALITÉ, ORIGINALITÉ. COMMUNIQUEZ CE QUE VOUS VOULEZ AVEC LES PRÉSENTOIRS ET LES STRUCTURES DE COMMUNICATION PIETRANERA, MAIS AUSSI VOUS POUVEZ LES UTILISER POUR SÉPARER LES PIÈCES ET PERSONNALISER VOTRE SALON EN LUI DONNANT LA PHYSIONOMIE QUI VOUS PLAÎT LE PLUS.

DE KLASSE, CHARME, PERSÖNLICHKEIT, ORIGINALITÄT, ERZÄHLEN SIE DAS WAS SIE MÖCHTEN, MIT DEN DISPLAYS UND STRUKTUREN FÜR DIE KOMMUNIKATION VON PIETRANERA, UND NICHT NUR DAS: SIE KÖNNEN DIESE AUCH VERWENDEN, UM JEDES EINZELNE AMBIENTE IN IHREM SALON GANZ NACH IHREN WÜNSCHEN ZU UNTERTEILEN.

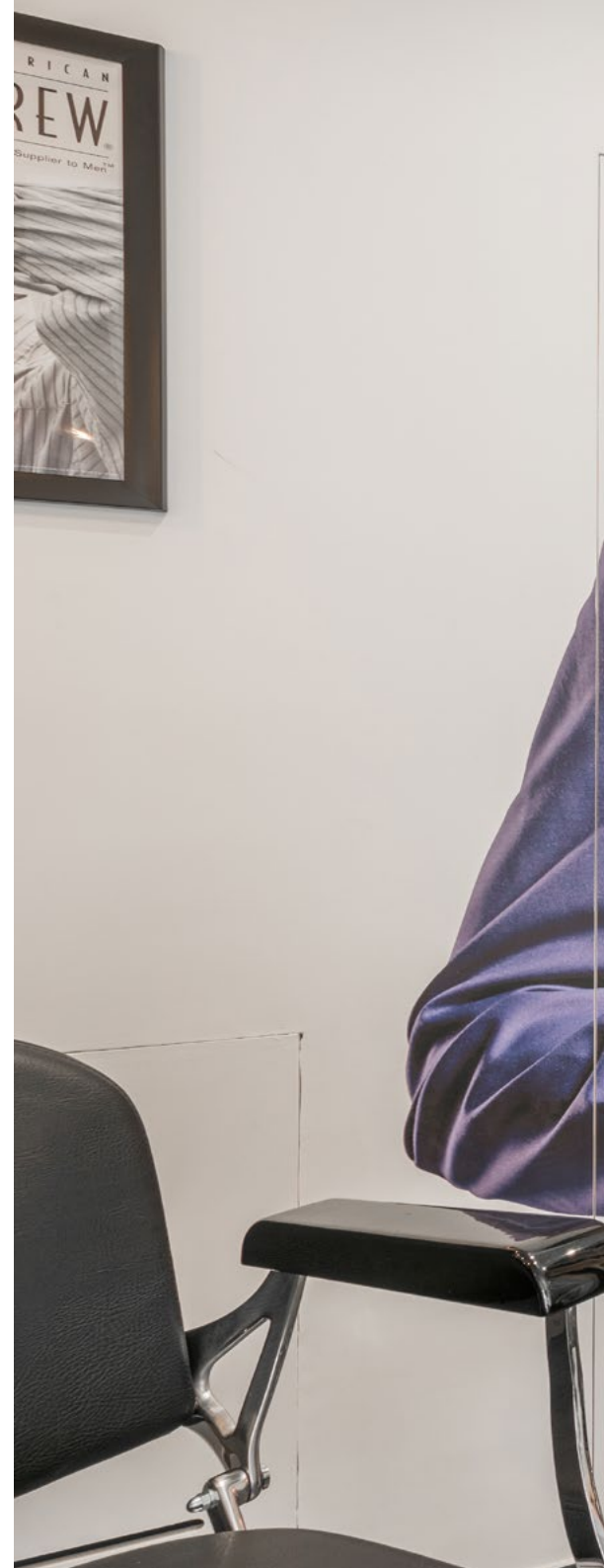



INCA
NTA
LUPO

INCA
NTA
LUPO

INCA
NTA
LUPO

INCA
NTA
LUPO



TENDA VETRINA

- PRINTED CURTAIN
- RIDEAU DE TISSU POUR VITRINE
- VORHANG FÜR SCHAUFENSTER

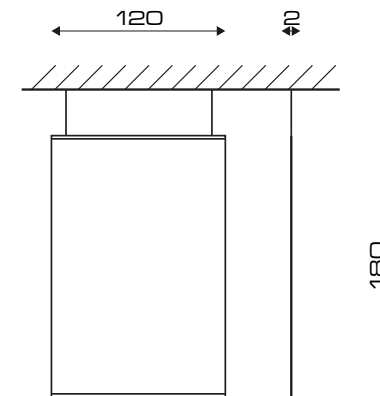

- PRODOTTI
- PRODUCTS
- PRODUITS
- PRODUKTEN

- OPZIONI
- OPTIONS
- OPTIONS
- OPTIONEN



COD. 1010

- TENDA PER VETRINA 120 X H 180 CM
- PRINTED FABRIC CURTAIN, FOR SHOP-WINDOW 120 X H 180 CM
- RIDEAU DE TISSU IMPRIMÉ POUR VITRINE 120 X H 180 CM
- VORHANG FÜR SCHAUFENSTER 120 X H 180 CM



[PAG.212 -213](#)

TELAIO DA VETRINA BIFACCIALE

- PRINTED FABRIC FOR SHOP WINDOW
- RIDEAU DE TISSU POUR VITRINE 2 CÔTÉS
- DOPPELSEITIG RAHMEN FÜR SCHAUFENSTER



INSTALLAZIONE / INSTALLATION
INSTALLATION / INSTALLATION

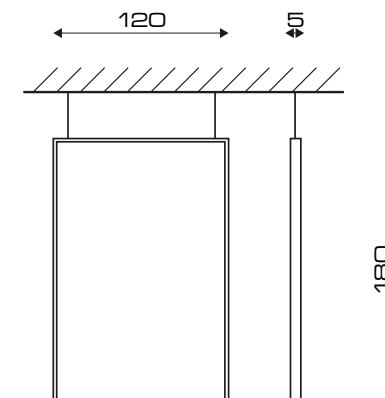

- PRODOTTI
- PRODUCTS
- PRODUITS
- PRODUKTEN

- ACCESSORI
- ACCESSORIES
- ACCESSOIRES
- ZUBEHÖR

- OPZIONI
- OPTIONS
- OPTIONS
- OPTIONEN



COD. 1011

- TELAIO DA VETRINA BIFACCIALE 120 X H 180 CM.
- FRAME W/PRINTED FABRIC ON BOTH SIDES FOR SHOP-WINDOW 120 X H 180 CM.
- RIDEAU DE TISSU IMPRIMÉ POUR VITRINE SUR LES 2 CÔTÉS 120 X H 180 CM.
- DOPPELSEITIG RAHMEN FÜR SCHAUFENSTER 120 X H 180 CM

COD. F1011

- RICAMBIO TELO VETRINA BIFACCIALE
- REPLACEABLE PRINTED FABRIC FOR SHOP WINDOW FRAME ON BOTH SIDE
- TISSU IMPRIMÉ REMPLAÇABLE POUR VITRINE SUR LES 2 CÔTÉS
- ERSATZBILD DOPPELSEITIG RAHMEN



[PAG.212 -213](#)

TENDA DIVISORIO

- PRINTED DIVISOR
- CLOISON DE TISSU
- VORHANG TEILER



INSTALLAZIONE / INSTALLATION
INSTALLATION / INSTALLATION

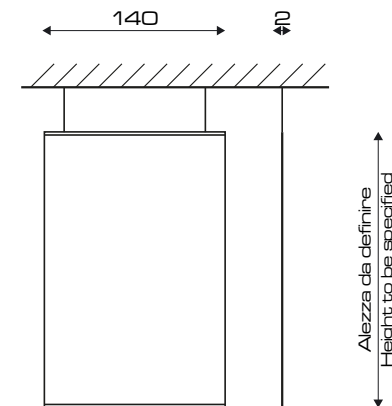

- PRODOTTI
- PRODUCTS
- PRODUITS
- PRODUKTEN

- OPZIONI
- OPTIONS
- OPTIONS
- OPTIONEN



COD. 1012

- DIVISORIO POSTAZIONE 140 CM X H DA SPECIFICARE
- PRINTED DIVISOR FABRIC 140 CM X H TO SPECIFY
- CLOISON DE TISSU IMPRIME 140 CM X H DE SPECIFIER
- VORHANG TEILER 140 CM X HÖHE ZU SPEZIFIZIEREN



[PAG.212 -213](#)

CIELINO

INSTALLAZIONE / INSTALLATION
INSTALLATION / INSTALLATION

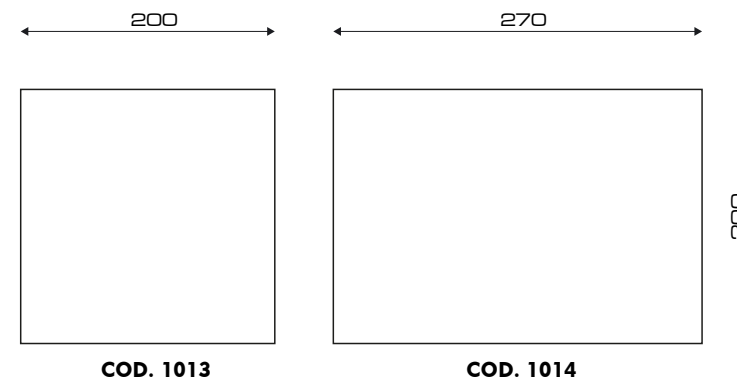
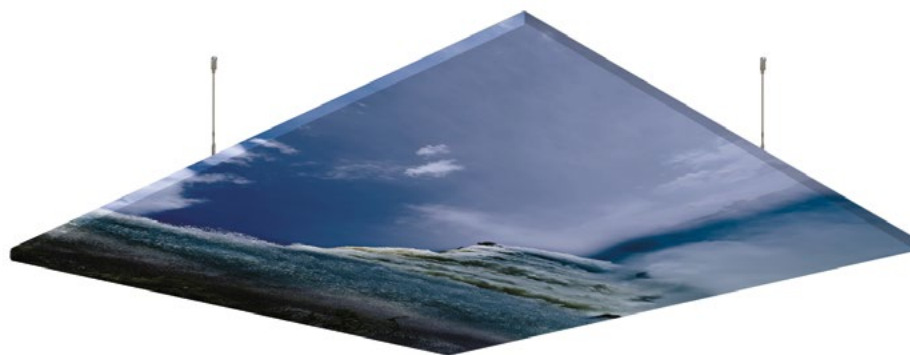

- PRODOTTI
- PRODUCTS
- PRODUITS
- PRODUKTEN

- ACCESSORI
- ACCESSORIES
- ACCESSOIRES
- ZUBEHÖR

- OPZIONI
- OPTIONS
- OPTIONS
- OPTIONEN



COD. 1013

- CIELINO 200X200 CM.
- PRINTED FABRIC FOR CEILING 200 X 200 CM.
- TISSU IMPRIMÉ POUR PLAFOND 200X200 CM.
- BILDER FÜR DECKE 200X200 CM.



COD. 1014

- CIELINO 270X200 CM.
- PRINTED FABRIC FOR CEILING 270 X 200 CM.
- TISSU IMPRIMÉ POUR PLAFOND 270X200 CM.
- BILDER FÜR DECKE 270X200 CM.

COD. F1013

- RICAMBIO TELO CIELINO 200X200 CM
- REPLACEABLE PRINTED FABRIC FOR CEILING 200X200 CM
- TISSU IMPRIMÉ REMPLAÇABLE POUR PLAFOND 200X200 CM
- ERSATZBILD, DRUCKSTOFF FÜR DECKE 200X200 CM

COD. F1014

- RICAMBIO TELO CIELINO 270X200 CM
- REPLACEABLE PRINTED FABRIC FOR CEILING 270X200 CM
- TISSU IMPRIMÉ REMPLAÇABLE POUR PLAFOND 270X200 CM
- ERSATZBILD, DRUCKSTOFF FÜR DECKE 270X200 CM



[PAG.212 -213](#)

CORNICI CON IMMAGINI

- FRAME WITH PRINTED FABRIC
- TISSU IMPRIMÉ' AVEC CADRE
- RAHMEN MIT BILDER-DRUCKSTOFF



[PAG.212 -213](#)

- PRODOTTI
- PRODUCTS
- PRODUITS
- PRODUKTEN

- ACCESSORI
- ACCESSORIES
- ACCESSOIRES
- ZUBEHÖR

- COD. F1015**
- RICAMBIO IMMAGINE 1015
 - REPLACEABLE PRINTED FABRIC FOR 1015
 - TISSU IMPRIMÉ REMPLAÇABLE POUR 1015
 - ERSATZBILD 1015
- COD. F1016**
- RICAMBIO IMMAGINE 1016
 - REPLACEABLE PRINTED FABRIC FOR 1016
 - TISSU IMPRIMÉ REMPLAÇABLE POUR 1016
 - ERSATZBILD 1016
- COD. F1017**
- RICAMBIO IMMAGINE 1017
 - REPLACEABLE PRINTED FABRIC FOR 1017
 - TISSU IMPRIMÉ REMPLAÇABLE POUR 1017
 - ERSATZBILD 1017

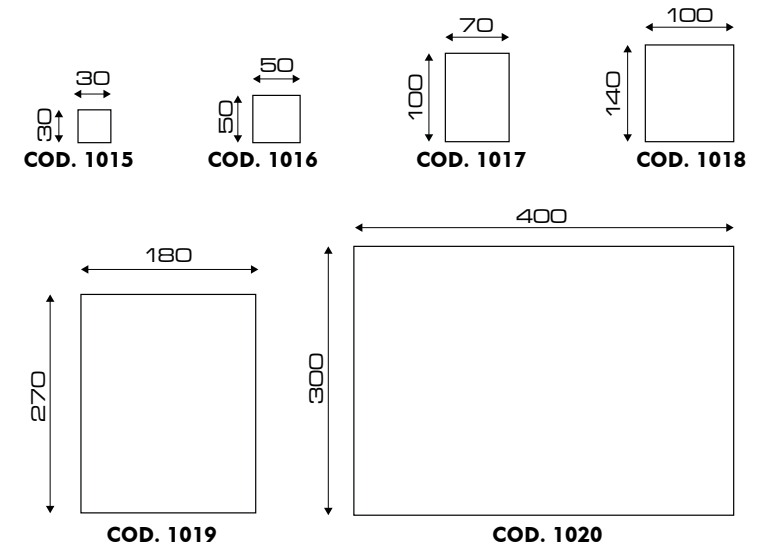

- COD. F1018**
- RICAMBIO IMMAGINE 1018
 - REPLACEABLE PRINTED FABRIC FOR 1018
 - TISSU IMPRIMÉ REMPLAÇABLE POUR 1018
 - ERSATZBILD 1018
- COD. F1019**
- RICAMBIO IMMAGINE 1019
 - REPLACEABLE PRINTED FABRIC FOR 1019
 - TISSU IMPRIMÉ REMPLAÇABLE POUR 1019
 - ERSATZBILD 1019
- COD. F1020**
- RICAMBIO IMMAGINE 1020
 - REPLACEABLE PRINTED FABRIC FOR 1020
 - TISSU IMPRIMÉ REMPLAÇABLE POUR 1020
 - ERSATZBILD 1020

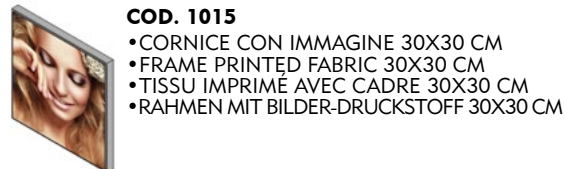

- COD. 1015**
- CORNICE CON IMMAGINE 30X30 CM
 - FRAME PRINTED FABRIC 30X30 CM
 - TISSU IMPRIMÉ AVEC CADRE 30X30 CM
 - RAHMEN MIT BILDER-DRUCKSTOFF 30X30 CM

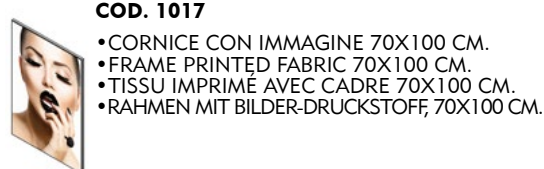

- COD. 1017**
- CORNICE CON IMMAGINE 70X100 CM.
 - FRAME PRINTED FABRIC 70X100 CM.
 - TISSU IMPRIMÉ AVEC CADRE 70X100 CM.
 - RAHMEN MIT BILDER-DRUCKSTOFF, 70X100 CM.

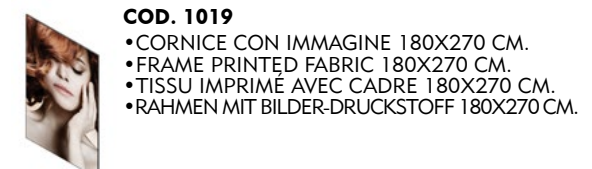

- COD. 1019**
- CORNICE CON IMMAGINE 180X270 CM.
 - FRAME PRINTED FABRIC 180X270 CM.
 - TISSU IMPRIMÉ AVEC CADRE 180X270 CM.
 - RAHMEN MIT BILDER-DRUCKSTOFF 180X270 CM.

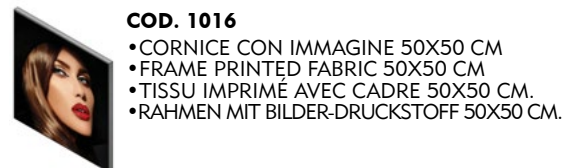

- COD. 1016**
- CORNICE CON IMMAGINE 50X50 CM
 - FRAME PRINTED FABRIC 50X50 CM
 - TISSU IMPRIMÉ AVEC CADRE 50X50 CM.
 - RAHMEN MIT BILDER-DRUCKSTOFF 50X50 CM.

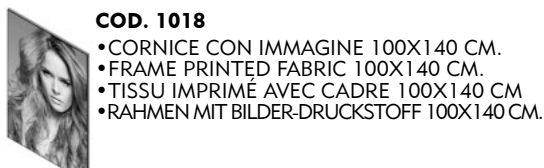

- COD. 1018**
- CORNICE CON IMMAGINE 100X140 CM.
 - FRAME PRINTED FABRIC 100X140 CM.
 - TISSU IMPRIMÉ AVEC CADRE 100X140 CM
 - RAHMEN MIT BILDER-DRUCKSTOFF 100X140 CM.

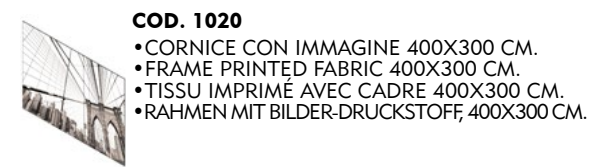

- COD. 1020**
- CORNICE CON IMMAGINE 400X300 CM.
 - FRAME PRINTED FABRIC 400X300 CM.
 - TISSU IMPRIMÉ AVEC CADRE 400X300 CM.
 - RAHMEN MIT BILDER-DRUCKSTOFF, 400X300 CM.

CHARME

- COLORI STANDARD
- STANDARD COLORS
- COULEURS STANDARD
- STANDARD FARBEN



- NERO LUCIDO
- GLOSSY BLACK
- NOIR BRILLANT
- GLANZSCHWARZ



- BIANCO LUCIDO
- GLOSS WHITE
- BLANC BRILLANT
- GLANZWEISS

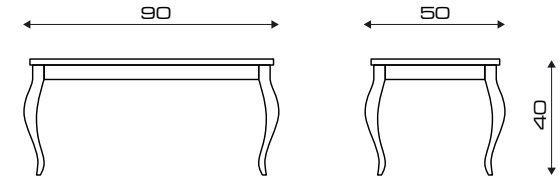

COD. 893B/N

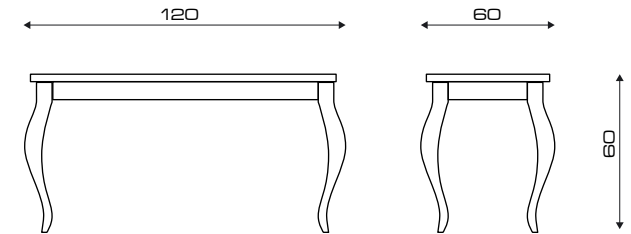

COD. 894B/N

- PRODOTTI
- PRODUCTS
- PRODUITS
- PRODUKTEN



COD. 893B

- TAVOLO SERVIZIO 90X50 CM H.40 CM BIANCO LUCIDO.
- SERVICE TABLE 90X50 CM H.40 CM GLOSS WHITE.
- TABLE DE SERVICE 90X50 CM H.40 CM BLANC BRILLANT
- 90X50 CM H.40 CM TISCH GLANZWEISS.



COD. 893N

- TAVOLO SERVIZIO 90X50 CM H.40 CM NERO LUCIDO
- SERVICE TABLE 90X50 CM H.40 CM GLOSS BLACK.
- TABLE DE SERVICE 90X50 CM H.40 CM NOIR BRILLANT.
- 90X50 CM H.40 CM TISCH GLANZSCHWARZ.



COD. 894B

- TAVOLO SERVIZIO 120X60 CM H.60 CM BIANCO LUCIDO.
- SERVICE TABLE 120X60 CM H.60 CM GLOSS WHITE.
- TABLE DE SERVICE 120X60 CM H.60 CM BLANC BRILLANT.
- 120X60 CM H.60 CM TISCH GLANZWEISS.



COD. 894N

- TAVOLO SERVIZIO 120X60 CM H.60 CM NERO LUCIDO
- SERVICE TABLE 120X60 CM H.60 CM GLOSS BLACK.
- TABLE DE SERVICE 120X60 CM H.60 CM NOIR BRILLANT.
- 120X60 CM H.60 CM TISCH GLANZSCHWARZ.

COCKTAIL

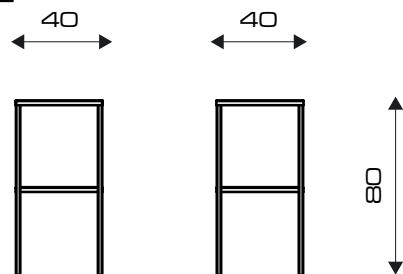

COD. 203

- PRODOTTI
- PRODUCTS
- PRODUITS
- PRODUKTEN

GEORGE



COD. 201

- PRODOTTI
- PRODUCTS
- PRODUITS
- PRODUKTEN

LINK



COD. 202

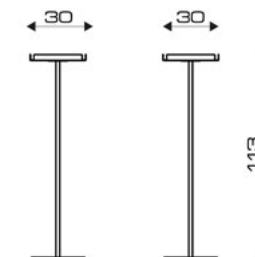

LINK - COD. 202

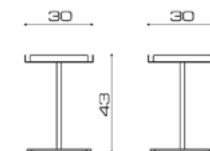

GEORGE - COD. 201

- PORTATA MASSIMA
- MAX. LOAD CARRYING WEIGHT
- POIDS MAXIMAL SUPPORTABLE
- MAXIMALE TRAGFÄHIGKEIT



COD. 203

- TAVOLINO INTERMEDIO INOX.
- INTERMEDIATE STAINLESS STEEL TABLE.
- TABLE INTERCALAIRE ACIER INOX.
- ZWISCHENTISCH.



COD. 201

- TAVOLINO BASSO IN ACCIAIO INOX SATINATO.
- SHORT MATT STAINLESS STEEL TABLE.
- TABLE DE ACIER INOX SATINÉ - COURT.
- NIEDRIGER TISCHCHEN, EDELSTAHL SATINIERT

COD. 202

- TAVOLINO ALTO IN ACCIAIO INOX SATINATO.
- TALL MATT STAINLESS STEEL TABLE.
- TABLE DE ACIER INOX SATINÉ - HAUT
- HOHER TISCHCHEN, EDELSTAHL SATINIERT

DUPLEX EXPO

- COLORI STANDARD STRUTTURA
- STRUCTURE STANDARD COLORS
- COULEURS STANDARD STRUCTURE
- STANDARD FARBEN STRUKTUR



- NERO OPACO
- MATT BLACK
- NOIR MAT
- MATT SCHWARZ



COD. 868.3

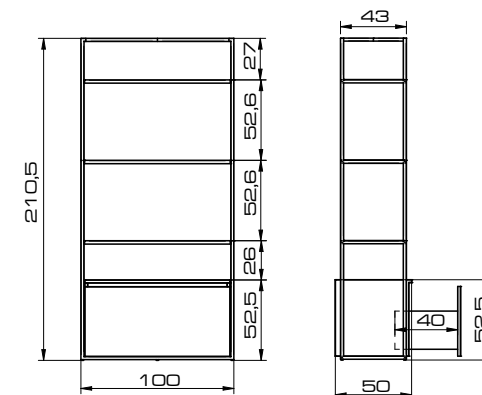

COD. 868.3



PAG.215

- PRODOTTI
- PRODUCTS
- PRODUITS
- PRODUKTEN

- ACCESSORI
- ACCESSORIES
- ACCESSOIRES
- ZUBEHÖR



COD. 868.3

- ESPOSITORE CON STRUTTURA E 3 PIANI IN METALLO VERNICIATO NERO, CASSETTONE DISPONIBILE NELLE FINITURE LEGNO.
- DISPLAY UNIT WITH BLACK METAL PAINTED STRUCTURE, WITH 3 SHELVES IN BLACK METAL PAINTED. BOTTOM DRAWER AVAILABLE IN WOODEN FINISHING COLOURS.
- PRÉSENTOIR AVEC STRUCTURE EN MÉTAL NOIR, AVEC 3 ÉTAGÈRES EN MÉTAL NOIR, TIROIR EN BOIS PERSONNALISABLE DANS LES FINITIONS BOIS.
- VERKAUFSREGAL MIT STRUKTUR UND 3 REGALEN AUS SCHWARZES LACKIERT METALL, SCHUBLADE VERFÜGBAR IN HOLZBESCHICHTUNGEN.

COD. FIN

- COLORI SPECIALI VERNICIATURA DELLA STRUTTURA E DEI PIANI.
- METAL PAINTING IN SPECIAL COLORS FOR STRUCTURE AND SHELVES.
- AUTRE COULEUR DU MÉTAL STRUCTURE ET ÉTAGÈRES DANS LES FINITION MÉTAL.
- SPEZIALFARBEN LACKIERUNG FÜR STRUKTUR UND REGALE.

HANG

INSTALLAZIONE / INSTALLATION
INSTALLATION / INSTALLATION

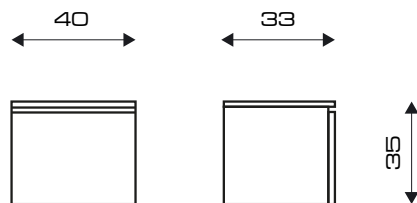

COD. 968

- PRODOTTI
- PRODUCTS
- PRODUITS
- PRODUKTEN

- ACCESSORI
- ACCESSOIRES
- ACCESSOIRES
- ZUBEHÖR

COD. FIN

- FINITURA BIANCA O NERO LUCIDO
- GLOSS WHITE OR BLACK FINISHING
- FINITIONS BLANCHE OU NOIR BRILLANT
- WEISS ODER SHWARZ GLÄNZEND BESCHICHTUNGEN

COD. 968

- PORTAPHON
- BLOW-DRYER HOLDER
- PORTE-SECHOIR
- PHÖNHALTER

KAM

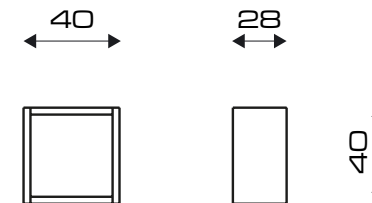

- PRODOTTI
- PRODUCTS
- PRODUITS
- PRODUKTEN

- ACCESSORI
- ACCESSOIRES
- ACCESSOIRES
- ZUBEHÖR

COD. FIN

- FINITURA BIANCA O NERO LUCIDO
- GLOSS WHITE OR BLACK FINISHING
- FINITIONS BLANCHE OU NOIR BRILLANT
- WEISS ODER SHWARZ GLÄNZEND BESCHICHTUNGEN

COD. 178

- MOBILE PENSILE, DISPONIBILE IN FINITURE LEGNI.
- WALL SHELF AVAILABLE IN WOODEN FINISHINGS.
- ETAGÈRE MURALE DISPONIBLE EN FINITIONS BOIS AU CHOIX.
- HÄNGESCHRANK VERFÜGBAR IN HOLZBESCHICHTUNGEN.



COD. 897

- MOBILE PENSILE CON CASSETTO, DISPONIBILE IN FINITURE LEGNI.
- WALL CABINET WITH DRAWER, AVAILABLE IN WOODEN FINISHINGS
- MEUBLE MURAL AVEC TIROIR, DISPONIBLE EN FINITIONS BOIS AU CHOIX.
- HÄNGESCHRANK MIT SCHUBLADE VERFÜGBAR IN HOLZBESCHICHTUNGEN.

EXPO LIGHT

EXPO LIGHT IMAGE



COD. 885

COD. 889



COD. 8851



COD. 8891

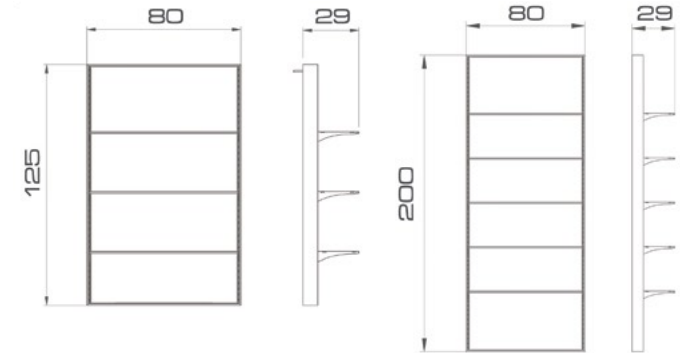

[PAG.212 -213](#)

- PRODOTTI
- PRODUCTS
- PRODUITS
- PRODUKTEN

- ACCESSORI
- ACCESSORIES
- ACCESSOIRES
- ZUBEHÖR



COD. 885

- ESPOSITORE EXPO-LIGHT CM 80X125, STRUTTURA IN ALLUMINIO ANODIZZATO, 3 PIANETTI IN CRISTALLO, RETROILL. A LED.
- EXPO-LIGHT WALL SHELVING UNIT CM 80X125, ANODIZED ALUMINIUM STRUCTURE, 3 ADJUSTABLE GLASS SHELVES, LED BACKLIGHTING.
- PRÉSENTOIR EXPO-LIGHT CM 80X125, STRUCTURE ALUMINIUM ANODISÉ, 3 TABLETTES RÉGLABLES CRISTAL, RÉTRO-ÉCLAIRAGE A LED.
- VERKAUFSREGAL EXPO-LIGHT CM 80X125, ALU STRUKTUR, 3 KRISTALL FLÄCHER UND RÜCKWAND BELEUCHTET MIT LED.



COD. 8851

- ESPOSITORE EXPO-LIGHT CM 80X125, STRUTTURA IN ALLUMINIO ANODIZZATO, 3 PIANETTI IN CRISTALLO, IMMAGINE SOST. E RETROILL. A LED.
- EXPO-LIGHT WALL STYLING UNIT CM 80X125, ANODIZED ALUMINIUM STRUCTURE, 3 ADJUSTABLE GLASS SHELVES WITH REPLACEABLE PICTURE AND LED BACKLIGHTING.
- PRÉSENTOIR EXPO-LIGHT CM 80X125, STRUCTURE ALUMINIUM ANODISÉ, 3 TABLETTES RÉGLABLES CRISTAL, IMAGE REMPLAÇABLE RÉTROÉCLAIRE A LED.
- VERKAUFSREGAL EXPO-LIGHT CM 80X125, ALU STRUKTUR, 3 KRISTALL FLÄCHER. BILD AUSWÄCHSELBAR UND RÜCKWAND BELEUCHTET MIT LED.



COD. 889

- ESPOSITORE EXPO-LIGHT CM 80X200, STRUTTURA IN ALLUMINIO ANODIZZATO, 5 PIANETTI IN CRISTALLO, RETROILL. A LED.
- EXPO-LIGHT WALL SHELVING UNIT CM 80X200, ANODIZED ALUM. STRUCTURE, 5 ADJUSTABLE GLASS SHELVES, LED BACKLIGHTING.
- PRÉSENTOIR EXPO-LIGHT CM 80X200, STRUCTURE ALUM. ANODISÉ, 5 TABLETTES RÉGLABLES CRISTAL, RÉTRO-ÉCLAIRAGE A LED.
- VERKAUFSREGAL EXPO-LIGHT CM 80X200, ALU STRUKTUR, 5 KRISTALL FLÄCHER UND RÜCKWAND BELEUCHTET MIT LED.



COD. 8891

- ESPOSITORE EXPO-LIGHT CM 80X200, STRUTTURA IN ALLUMINIO ANODIZZATO, 5 PIANETTI IN CRISTALLO, IMMAGINE SOST. RETROILL. A LED.
- EXPO-LIGHT WALL STYLING UNIT CM 80X200, ANODIZED ALUMINIUM STRUCTURE, 5 ADJUSTABLE GLASS SHELVES, WITH REPLACEABLE PICTURE AND LED BACKLIGHTING.
- PRÉSENTOIR EXPO-LIGHT CM 80X200, STRUCTURE ALUMINIUM ANODISÉ, 5 TABLETTES RÉGLABLES, IMAGE REMPLAÇABLE RÉTROÉCLAIRE A LED.
- VERKAUFSREGAL EXPO-LIGHT CM 80X200, ALU STRUKTUR, 5 KRISTALL FLÄCHER. BILD AUSWÄCHSELBAR UND RÜCKWAND BELEUCHTET MIT LED.

COD. 752

- IMMAGINE DI RICAMBIO PER 8851
- REPLACEABLE PICTURE FOR 8851
- IMAGE REMPLAÇABLE POUR 8851
- ERSATZBILD FÜR 8851

COD. 753

- IMMAGINE DI RICAMBIO PER 8891
- REPLACEABLE PICTURE FOR 8891
- IMAGE REMPLAÇABLE POUR 8891
- ERSATZBILD FÜR 8891

ATTESE WAITING CHAIRS ATTENTES WARTE SESSEL

IT CON LE ATTESE PIETRANERA, IL CLIENTE ASPETTA IL SUO TURNO CIRCONDATO DALLA BELLEZZA DI UN ARREDO SOLIDO, VERSATILE E COMODO. OGNI DIVANO, OGNI POLTRONA, OGNI POUF È UN PEZZO UNICO DALLA SPICCATATA PERSONALITÀ, PROPRIO COME QUELLA DEL COIFFEUR CHE RAPPRESENTA.

EN WHEN CLIENTS WAIT IN A PIETRANERA SALON, THEY'RE SURROUNDED BY THE BEAUTY OF COMFORTABLE, VERSATILE, WELL-MADE FURNISHINGS. EVERY COUCH, EVERY CHAIR AND EVERY POUFFE POSSESSES ITS OWN, UNIQUE STYLE, JUST LIKE THE COIFFEUR IT REPRESENTS.

FR AVEC LES PLACES D'ATTENTE PIETRANERA, LE CLIENT ATTEND SON TOUR ENTOURÉ PAR LA BEAUTÉ D'UN MOBILIER SOLIDE, POLYVALENT ET PRATIQUE. CHAQUE DIVAN, CHAQUE FAUTEUIL, CHAQUE POUF EST UN ARTICLE UNIQUE A FORTE PERSONNALITÉ, COMME CELLÉ DU COIFFEUR QU'IL REPRÉSENTE.

DE MIT DEN POUF "ATTESE" VON PIETRANERA WARTET DER KUNDE BIS ER DRAN IST, UMGEBEN VON DER SCHÖNHEIT EINER SOLIDEN, VIELSEITIGEN UND BEQUEMEN EINRICHTUNG. JEDES SOFA, JEDER SESSEL, JEDER POUF IST EIN EINZIGARTIGES STÜCK VON GENAUSO STARKER PERSÖNLICHKEIT WIE DER COIFFEUR SELBST IN SEINEM SALON.





COMFORT

TAPPEZZERIA / UPHOLSTERY
TAPISSERIE / POLSTER

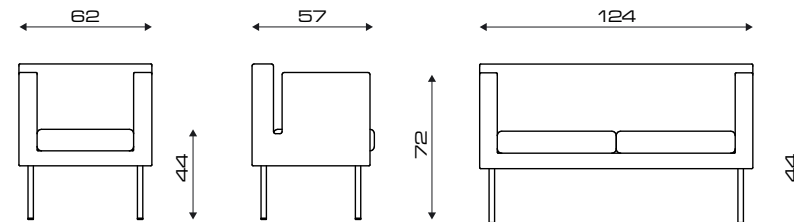

COD. 105.1



COD. 105.2

- PRODOTTI
- PRODUCTS
- PRODUITS
- PRODUKTEN

- ACCESSORI
- ACCESSORIES
- ACCESSOIRES
- ZUBEHÖR



COD. 105.1

- POLTRONA ATTESA SINGOLA
- SINGLE WAITING CHAIR
- FAUTEUIL ATTENTE SIMPLE
- EINZEL WARTESSEL



COD. 105.2

- DIVANO ATTESA 2 POSTI
- 2 SEATER WAITING SOFA
- SOFA ATTENTE 2 PLACES
- ZWEISITZER WARTESSEL

COD. SPECIAL

- SKAI SPECIAL ATTESA SINGOLA
- SKAI SPECIAL SINGLE WAITING CHAIR
- SKAI SPECIAL ATTENTE SIMPLE
- SKAI SPECIAL EINZEL WARTESSEL

COD. SPECIAL

- SKAI SPECIAL ATTESA 2 POSTI
- SKAI SPECIAL 2-SEATER SETTEE
- SKAI SPECIAL ATTENTE 2 PLACES
- SKAI SPECIAL ZWEISITZER WARTESSEL

MINE

TAPPEZZERIA / UPHOLSTERY
TAPISSERIE / POLSTER

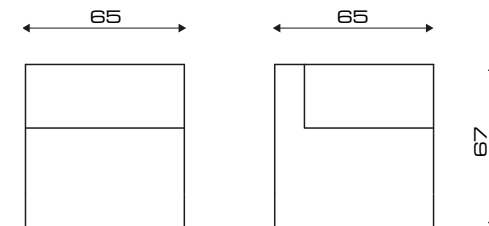

- PRODOTTI
- PRODUCTS
- PRODUITS
- PRODUKTEN

- ACCESSORI
- ACCESSORIES
- ACCESSOIRES
- ZUBEHÖR



COD. 184

- POLTRONA ATTESA SINGOLA
- SINGLE WAITING CHAIR
- FAUTEUIL ATTENTE SIMPLE
- EINZEL WARTESSEL



COD. 184.1

- POLTRONA ATTESA SINGOLA CENTRALE
- SINGLE WAITING CHAIR CENTRAL POSITION
- FAUTEUIL ATTENTE SIMPLE POSITION CENTRALE
- EINZEL WARTESSEL ZENTRALE

COD. SPECIAL

- SKAI SPECIAL
- SKAI SPECIAL
- SKAI SPECIAL
- SKAI SPECIAL

CORNER

TAPPEZZERIA / UPHOLSTERY
TAPISSERIE / POLSTER

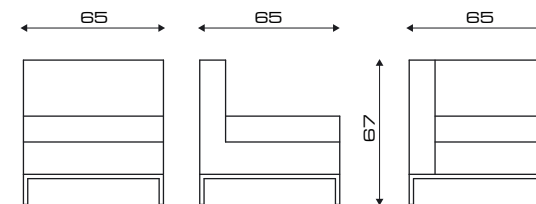

- PRODOTTI
- PRODUCTS
- PRODUITS
- PRODUKTEN

- ACCESSORI
- ACCESSORIES
- ACCESSOIRES
- ZUBEHÖR



COD. 185

- POLTRONA ATTESA SINGOLA
- SINGLE WAITING CHAIR
- FAUTEUIL ATTENTE SIMPLE
- EINZEL WARTESSEL



COD. 185.1

- POLTRONA ATTESA SINGOLA CENTRALE
- SINGLE WAITING CHAIR CENTRAL POSITION
- FAUTEUIL ATTENTE SIMPLE POSITION CENTRALE
- EINZEL WARTESSEL ZENTRALE

COD. SPECIAL

- SKAI SPECIAL
- SKAI SPECIAL
- SKAI SPÉCIAL
- SKAI SPECIAL

CORNER OPTIMA

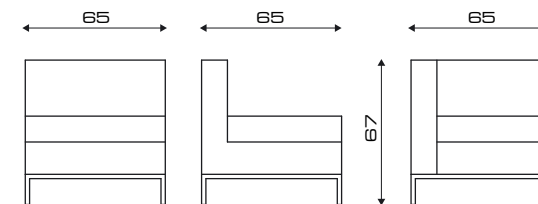

- PRODOTTI
- PRODUCTS
- PRODUITS
- PRODUKTEN

- ACCESSORI
- ACCESSORIES
- ACCESSOIRES
- ZUBEHÖR



COD. 185B

- POLTRONA ATTESA SINGOLA
- SINGLE WAITING CHAIR
- FAUTEUIL ATTENTE SIMPLE
- EINZEL WARTESSEL



COD. 185B.1

- POLTRONA ATTESA SINGOLA CENTRALE
- SINGLE WAITING CHAIR CENTRAL POSITION
- FAUTEUIL ATTENTE SIMPLE POSITION CENTRALE
- EINZEL WARTESSEL ZENTRALE

COD. SPECIAL

- SKAI SPECIAL
- SKAI SPECIAL
- SKAI SPÉCIAL
- SKAI SPECIAL

CARRELLI TROLLEYS TABLES DE SERVICE ARBEITSWAGEN

IT DESIGN GIOVANE ED ESSENZIALE, MATERIALI CONTEMPORANEI E GRANDE ATTENZIONE ALLA COMODITÀ: I COMPLEMENTI D'ARREDO PIETRANERA RACCHIUDONO IN OGNI CASSETTO TUTTE LE CARATTERISTICHE NECESSARIE PER LAVORARE IN ASSOLUTO BENESSERE.

EN TRENDY, CLEAN-CUT DESIGN, MODERN MATERIALS AND UTTERLY CONVENIENT: PIETRANERA FURNISHINGS PROVIDE EVERYTHING YOU NEED TO WORK WITHOUT A CARE.

FR DESIGN JEUNE ET ESSENTIEL, MATÉRIAUX CONTEMPORAINS ET GRANDE ATTENTION A LA COMMODITÉ: LES MOBILIERS DE RANGEMENT PIETRANERA RENFERME DANS CHAQUE TIROIR TOUTES LES CARACTÉRISTIQUES NÉCESSAIRES POUR TRAVAILLER DANS LE BIEN-ÊTRE ABSOLU.

DE JUNGES UND ESSENTIELLES DESIGN, MODERNE MATERIALIEN UND VIEL SORGFALT BEIM KOMFORT. DIE EINRICHTUNGSZUBEHÖRTEILE PIETRANERA UMSCHLIESSEN IN JEDER SCHUBLADE DIE NOTWENDIGEN MERKMALE FÜR EIN KOMFORTABLES ARBEITEN.





CHARIOT A

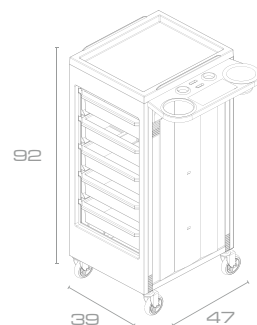

CHARIOT B



- PRODOTTI
- PRODUCTS
- PRODUITS
- PRODUKTEN

- PRODOTTI
- PRODUCTS
- PRODUITS
- PRODUKTEN



COD. 133-BIA

- CARRELLO DI SERVIZIO BIANCO, CASSETTI APERTI.
- WHITE SERVICE TROLLEY WITH OPEN DRAWERS.
- TABLE DE SERVICE BLANC AVEC TIROIRS OUVERTS.
- WEISSEN ARBEITSWAGEN, MIT OFFENEN SCHUBLADEN



COD. 133-NER

- CARRELLO DI SERVIZIO NERO, CASSETTI APERTI.
- BLACK SERVICE TROLLEY WITH OPEN DRAWERS.
- TABLE DE SERVICE NOIR AVEC TIROIRS OUVERTS.
- SCHWARZEN ARBEITSWAGEN, MIT OFFENEN SCHUBLADEN.



COD. 134-BIA

- CARRELLO DI SERVIZIO BIANCO, CASSETTI CHIUSI.
- WHITE SERVICE TROLLEY WITH CLOSED DRAWERS.
- TABLE DE SERVICE BLANC AVEC TIROIRS FERMÉES
- WEISSEN ARBEITSWAGEN, MIT GESCHLOSSENEN SCHUBLADEN



COD. 134-NER

- CARRELLO DI SERVIZIO NERO, CASSETTI CHIUSI.
- BLACK SERVICE TROLLEY WITH CLOSED DRAWERS.
- TABLE DE SERVICE NOIR AVEC TIROIRS FERMÉES.
- SCHWARZEN ARBEITSWAGEN, MIT GESCHLOSSENEN SCHUBLADEN.

SPOT

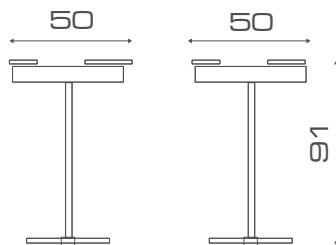

- PRODOTTI
- PRODUCTS
- PRODUITS
- PRODUKTEN



COD. 135

- CARRELLO PROFESSIONALE DA LAVORO NERO.
- PROFESSIONAL BLACK TROLLEY.
- TABLE DE SERVICE PROFESSIONELLE NOIRE.
- PROFESSIONELLER ARBEITSWAGEN SCHWARZ.

DOLLY



- PRODOTTI
- PRODUCTS
- PRODUITS
- PRODUKTEN



COD. 128.01

- CARRELLO DI SERVIZIO BIANCO.
- SERVICE TROLLEY IN WHITE.
- TABLE DE SERVICE COULEUR BLANC.
- ARBEITSWAGEN WEISS.



COD. 128.03

- CARRELLO DI SERVIZIO NERO.
- SERVICE TROLLEY IN BLACK.
- TABLE DE SERVICE COULEUR NOIR.
- ARBEITSWAGEN SCHWARZ.

HIGHLINE



PAG.214

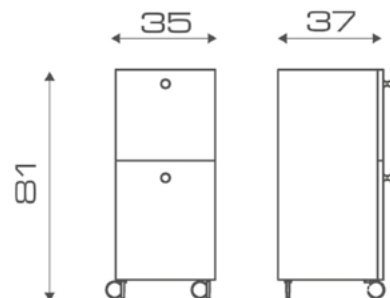

COD. 968



- PRODOTTI
- PRODUCTS
- PRODUITS
- PRODUKTEN



COD. 898

- CARRELLO DI SERVIZIO IN NOBILITATO CON DUE CASSETTI, DISP. IN FINITURE LEGNO.
- SERVICE TROLLEY WITH 2 DRAWERS, MELAMINE-FACED AVAILABLE IN WOODEN FINISHINGS.
- TABLE DE SERVICE EN MELAMINÉ AVEC 2 TIROIRS, DISPONIBLES EN FINITIONS BOIS.
- ARBEITSWAGEN AUS MELAMIN MIT 2 SCHUBLADEN, VERFÜGBAR IN HOLZBESCHICHTUNGEN.

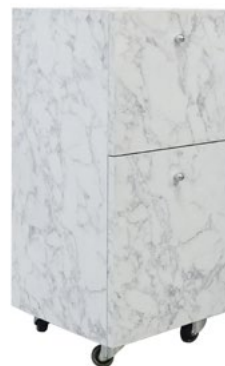

- ACCESSORI
- ACCESSORIES
- ACCESSOIRES
- ZUBEHÖR

COD. FIN

- FINITURA BIANCA O NERA LUCIDA
- GLOSS WHITE AND BLACK FINISHINGS
- FINITIONS BOIS BLANC ET NOIR BRILLANT
- WEISS ODER SCHWARZ GLÄNZEND ENDBEARBEITUNG

COD. 968

- PORTAPHON PER HIGHLINE
- BLOW-DRYER HOLDER FOR HIGHLINE
- PORTE-SECHOIR HIGHLINE ET MOB
- PHÖNHALTER FÜR HIGHLINE

TROLLEY

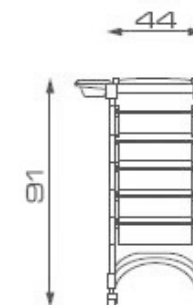

- PRODOTTI
- PRODUCTS
- PRODUITS
- PRODUKTEN



COD. 129.03

- CARRELLO DI SERVIZIO NERO.
- SERVICE TROLLEY IN BLACK.
- TABLE DE SERVICE COL.NOIR.
- ARBEITSWAGEN SCHWARZ.

UNIT



- PRODOTTI
- PRODUCTS
- PRODUITS
- PRODUKTEN



COD. 126.01

- CARRELLO DI SERVIZIO BIANCO.
- SERVICE TROLLEY IN WHITE.
- TABLE DE SERVICE COLEUR BLANC.
- ARBEITSWAGEN WEISS.



COD. 126.03

- CARRELLO DI SERVIZIO NERO.
- SERVICE TROLLEY IN BLACK.
- TABLE DE SERVICE COLEUR NOIR.
- ARBEITSWAGEN SCHWARZ.

VANGUARD

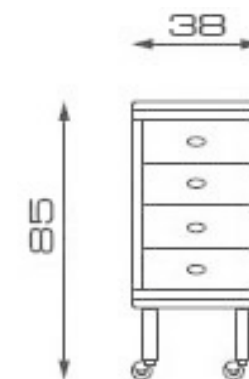

- PRODOTTI
- PRODUCTS
- PRODUITS
- PRODUKTEN

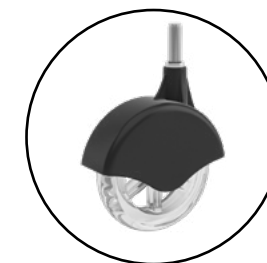

- PARTICOLARE RUOTA
- WHEEL VIEW
- VUE ROUE
- RAD EINZELHEIT



COD. 127.01

- CARRELLO DI SERVIZIO NERO, CASSETTI BIANCHI.
- SERVICE TROLLEY IN BLACK WITH WHITE DRAWERS.
- TABLE DE SERVICE COL.NOIR AVEC TIROIRS BLANCS.
- ARBEITSWAGEN SCHWARZ, WEISSE SCHUBLADEN.



COD. 127.03

- CARRELLO DI SERVIZIO NERO, CASSETTI NERI.
- SERVICE TROLLEY IN BLACK WITH BLACK DRAWERS.
- TABLE DE SERVICE COL.NOIR AVEC TIROIRS NOIRS.
- ARBEITSWAGEN SCHWARZ, SCHWARZE SCHUBLADEN.

WALLY



- VISTA RETRO
- REAR VIEW
- VUE ARRIÈRE
- RÜCKSEITE

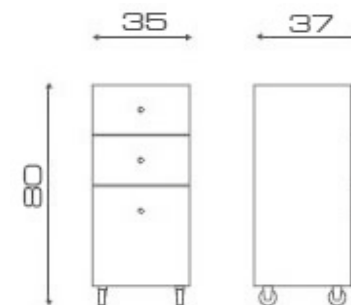

- RIVESTITO IN ACCIAO INOX
- COATED IN STAINLESS STEEL
- REVÊTU D'ACIER INOXYDABLE
- AUS EDELSTAHL BESCHICHTET

- PRODOTTI
- PRODUCTS
- PRODUITS
- PRODUKTEN



COD. 661.3

- CARRELLO CON 1 CASSETTO INOX GRANDE + 2 CASSETTI INOX PICCOLI.
- ST.STEEL TROLLEY ON CASTORS - 1 LARGE AND 2 SMALL DRAWERS.
- TABLE DE SERVICE INOX SUR ROULETTES - 1 TIROIR GRAND ET 2 PETITS.
- ARBEITSWAGEN AUS EDELSTAHL MIT 1 GROSSE UND 2 KLEINEN SCHUBLADEN.

ACCESSORI / ACCESSORIES / ACCESSOIRES / ZUBEHÖR



GALAXY COD. 969

- PORTA PHON GALAXY IN FUSIONE DI ALLUMINIO A PARETE
- WALL HAIRDRYER HOLDER GALAXY IN ALUMINUM CASTING.
- PORTE-SÉCHOIR MURAL GALAXY EN FUSION D' ALUMINIUM.
- WANDPHÖNHALTER GALAXY AUS ALLUMINIUMGUSS.



STAND - COD. 621

- POGGIPIEDI STAND
- STAND FOOTREST
- REPOSE-PIEDS STAND
- FUSSSTÜTZE STAND



STAND GOLD - COD. 621G

- POGGIPIEDI CROMATO ORO CON PROTEZIONE NERA
- GOLD CHROME-PLATED FOOTREST WITH BLACK PROTECTION
- REPOSE-PIEDS CHROMÉ OR AVEC PROTECTION NOIRE
- GOLDVERCHROMTE FUSSSTÜTZE MIT SCHWARZEM SCHUTZ



MOVE - COD. 626

- POGGIPIEDI MOVE
- MOVE FOOTREST
- REPOSE-PIEDS MOVE
- FUSSSTÜTZE MOVE



MOVE BLACK - COD. 626N

- POGGIPIEDI MOVE VERNICIATO NERO
- MOVE FOOTREST BLACK PAINTED
- REPOSE-PIEDS MOVE PEINT EN NOIR
- FUSSSTÜTZE MOVE SCHWARZ LACKIERT



SUN - COD. 624

- POGGIPIEDI SUN
- SUN FOOTREST
- REPOSE-PIEDS SUN
- FUSSSTÜTZE SUN



DAN - COD. 57

- POGGIPIEDI DAN
- DAN FOOTREST
- REPOSE-PIEDS DAN
- FUSSSTÜTZE DAN



COD. 122

- APPENDINO PORTABORSA
- BAG HANGER
- PORTE SAC
- TASCHENHALTER



COD. 144

- PORTA FLACONE SOLO PER LAVAGGI WEN
- SHAMPOO HOLDER ONLY FOR WEN WASHUNITS
- PORTE-SHAMPOOING JUSTE POUR BACS WEN
- FLASCHEHALTER NUR FÜR WASCHANLAGE WEN



COD. 125

- VASSOIO TECNICO TRAY POLTRONA LUNGO PER POLTRONA BOLERO, BOLERO OPTIMA, JOLIE, LONDRA EASY, LONDRA MID, LONDRA OPTIMA, ZONE.
- TECHNICAL TRAY WITH SHORT ARM FOR CHAIR BOLERO, BOLERO OPTIMA, JOLIE, LONDRA EASY, LONDRA MID, LONDRA OPTIMA, ZONE.
- PLATEAU TECHNIQUE TRAY AVEC BRAS LONGUE POUR FAUTEUIL BOLERO, BOLERO OPTIMA, JOLIE, LONDRA EASY, LONDRA MID, LONDRA OPTIMA, ZONE.
- ABLAUF TRAY, LANGEN ARM FÜR BOLERO, BOLERO OPTIMA, JOLIE, LONDRA EASY, LONDRA MID, LONDRA OPTIMA, ZONE.



COD. 124

- VASSOIO TECNICO TRAY BRACCIO CORTO PER POLTRONA AMELIA, AMY, KELLY, MOR, SE-X.
- TECHNICAL TRAY WITH SHORT ARM FOR CHAIR AMELIA, AMY, KELLY, MOR, SE-X.
- PLATEAU TECHNIQUE TRAY AVEC BRAS COURT POUR FAUTEUIL AMELIA, AMY, KELLY, MOR, SE-X. ABLAUF TRAY, KURZE ARM FÜR MELIA, AMY, KELLY, MOR, SE-X.



COD. 901

- PORTAPHON SNODABILE CROMATO PER MENSOLA.
- SWIVEL CHROME-PLATED HAIRDRYER HOLDER FOR SHELF.
- PORTE-SÉCHOIR ARTICULÉ CHROMÉ POUR TABLETTE.
- VERCHROMTER GELENK-HAARTROCKNERHALTER FÜR FLACHBETT



COD. CLICHE' EMBOSING

- REALIZZAZIONE CLICHÉ PER EMBOSING PERSONALIZZATO.
- PERSONALIZED CLICHE FOR EMBOSING.
- REALISATION CLICHÉ POUR EMBOSING PERSONALISÉ.
- KLISCHEE REALISIERUNG FÜR PERSONALISIERTE EMBOSING.



COD. EMBOSING

- STAMPA EMBOSING SINGOLA.
- EMBOSING SINGLE PRINTING.
- IMPRESSION SIMPLE EMBOSING.
- EINZELN EMBOSING AUSDRUCK.

ELETTRICI EQUIPMENTS ELECTRIQUES TROCKENHAUBEN

IT CASCHI, LAMPADE, STERILIZZATORI: GLI ACCESSORI ELETTRICI PIETRANERA CONTRIBUISCONO, CON TUTTA LA LORO CARICA DI INNOVAZIONE, A SEMPLIFICARTI IL LAVORO E A GARANTIRTI LA MASSIMA SICUREZZA, PER RISULTATI AL DI SOPRA DELLE ASPETTATIVE.

EN HAIR DRYERS, LAMPS, STERILIZERS: HIGHLY INNOVATIVE, PIETRANERA ELECTRICAL ACCESSORIES HELP TO SIMPLIFY THE HAIRSTYLIST'S WORK WHILE GUARANTEEING MAXIMUM SAFETY AND RESULTS WELL ABOVE YOUR EXPECTATIONS.

FR CASQUES, LAMPES, STÉRILISATEURS : LES ACCESSOIRES ÉLECTRIQUES PIETRANERA CONTRIBUENT, AVEC TOUTE LEUR CHARGE D'INNOVATION, A VOUS SIMPLIFIER LE TRAVAIL ET A VOUS GARANTIR LA SÉCURITÉ MAXIMALE, POUR DES RÉSULTATS AU-DELÀ DE TOUTE ATTENTE.

DE HAUBEN, LAMPEN, STERILISATOREN: DIE ELEKTRISCHEN ZUBEHÖRTEILE PIETRANERA MIT IHRER INNOVATIVEN LEISTUNG TRAGEN DAZU BEI DIE ARBEIT ZU ERLEICHTERN UND MAXIMALE SICHERHEIT FÜR ÜBERDURCHNITTLICHE ERGEBNISSE ZU GEWÄHRLEISTEN.





HELL-MET

- VOLTAGGIO: 230 V
- VOLTAGE
- VOLTAGE
- SPANNUNG

- POTENZA: 1120 W - 1140 W
- POWER
- PUISSANCE
- MACHT

- FREQUENZA: 50/60 HZ
- FREQUENCY
- FRÉQUENCE
- FREQUENZ

- NR. VELOCITÀ: 1 - 2 - 4
- NR. SPEED
- NR. VITESSE
- NR. GESCHWINDIGKEIT

- TIMER: 60'
- TIMER
- TIMER
- TIMER



- BIANCO
- WHITE
- BLANC
- WEISS



- NERO
- BLACK
- NOIR
- SCHWARZ



COD. BP21

- NERO
- BLACK
- NOIR
- SCHWARZ



COD. BP22

- NERO
- BLACK
- NOIR
- SCHWARZ



COD. B193

- NERO
- BLACK
- NOIR
- SCHWARZ



COD. B193

- BIANCO
- WHITE
- BLANC
- WEISS

Ø 35

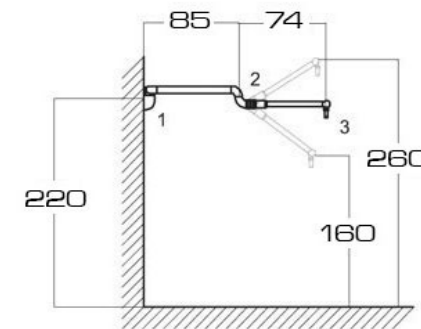
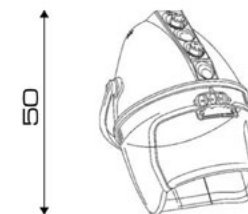

COD. B193

- PRODOTTI
- PRODUCTS
- PRODUITS
- PRODUKTEN

- ACCESSORI
- ACCESSORIES
- ACCESSOIRES
- ZUBEHÖR

COD. 730.21

- CASCO COLORE BIANCO O NERO, VENTILAZIONE DIRETTA, BASE COD. BP21 CON PIEDE E TUBO COLORE NERO.
- HAIRDRYER COLOUR BLACK OR WHITE, DIRECT VENTILATION, BASE COD. BP21 WITH BLACK BASE AND TUBE.
- CASQUE COULEUR BLANC OU NOIR, VENTILATION DIRECTE, PIED COD. BP21 AVEC BASE ET TUBE NOIRES.
- HAARTROCKNER WEISS ODER SCHWARZ, DIREKTBELÜFTUNG, MIT FUSS COD. BP21, SCHWARZER FUSS UND SCHLAUCH.

COD. 730.22

- CASCO BIANCO O NERO, VENTILAZIONE DIRETTA, CON BASE COD. BP22, CON PIEDE E TUBO COLORE NERO.
- HAIRDRYER COLOUR BLACK OR WHITE, DIRECT VENTILATION, BASE COD. BP22, WITH BLACK BASE AND TUBE.
- CASQUE COULEUR BLANC OU NOIR, VENTILATION DIRECTE, PIED COD. BP22, AVEC BASE ET TUBE NOIRES.
- HAARTROCKNER WEISS ODER SCHWARZ, DIREKTBELÜFTUNG, MIT FUSS COD. BP22, SCHWARZER FUSS UND SCHLAUCH.

COD. 730.193

- CASCO COLORE BIANCO O NERO, VENTILAZIONE DIRETTA, CON BRACCIO COD. B193 DISPONIBILE IN COLORE BIANCO O NERO E CON CUFFIE NERE.
- HAIRDRYER COLOUR BLACK OR WHITE, DIRECT VENTILATION, WITH WALL ARM COD. B193 AVAILABLES IN COLOUR WHITE OR BLACK AND COVERING CAPS BLACK.
- CASQUE COULEUR BLANC OU NOIR, VENTILATION DIRECTE, AVEC BRAS MURAL COD. B193 DISPONIBLE EN COULEUR BLANC OU NOIR ET CAPOTS DE PROTECTION NOIRES.
- HAARTROCKNER WEISS ODER SCHWARZ, DIREKTBELÜFTUNG, MIT WANDARM COD. B193 WEISS ODER SCHWARZ. SCHWARZE GELENKABDECKUNGEN.

2VEL

- SUPPLEMENTO 2 VELOCITÀ.
- 2 SPEEDS EXTRA CHARGE.
- SUPPLÉMENT 2 VITESSES.
- AUFPREIS FÜR 2 GESCHWINDIGKETEN.

4VEL

- SUPPLEMENTO 4 VELOCITÀ.
- 4 SPEEDS EXTRA CHARGE.
- SUPPLÉMENT 4 VITESSES.
- AUFPREIS FÜR 4 GESCHWINDIGKETEN.

110V

- SUPPLEMENTO 110 VOLT.
- 110 VOLT EXTRA CHARGE.
- SUPPLÉMENT 4 VITESSES 110 VOLTS
- AUFPREIS FÜR 110 VOLTS.

STYLE

- **VOLTAGGIO: 230 V**
- VOLTAGE
- VOLTAGE
- SPANNUNG

- **POTENZA: 1150 W**
- POWER
- PUISSANCE
- MACHT

- **FREQUENZA: 50/60 HZ**
- FREQUENCY
- FRÉQUENCE
- FREQUENZ

- **NR. VELOCITÀ: 5**
- NR. SPEED
- NR. VITESSE
- NR. GESCHWINDIGKEIT

- **TIMER: 99'**
- TIMER
- TIMER
- TIMER



- BIANCO
- WHITE
- BLANC
- WEISS



- NERO
- BLACK
- NOIR
- SCHWARZ



- SILVER
- SILVER
- SILVER
- SILBER



COD. BP21

- NERO
- BLACK
- NOIR
- SCHWARZ



COD. BP22

- NERO
- BLACK
- NOIR
- SCHWARZ



COD. B193

- NERO
- BLACK
- NOIR
- SCHWARZ



COD. B193

- BIANCO
- WHITE
- BLANC
- WEISS

Ø 33

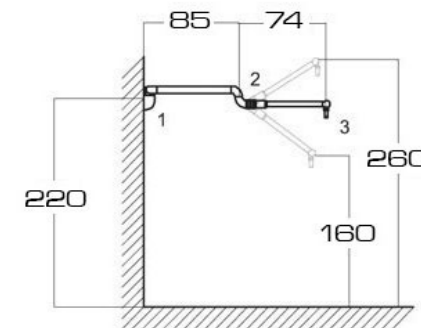
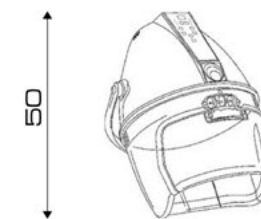

COD. B193

- ACCESSORI
- ACCESSORIES
- ACCESSOIRES
- ZUBEHÖR

- PRODOTTI
- PRODUCTS
- PRODUITS
- PRODUKTEN

COD. 731.21

- CASCO DIGITALE COLORE BIANCO, NERO O SILVER, VENTILAZIONE DIRETTA, CON BASE COD. BP21, CON PIEDE E TUBO COLORE NERO.
- DIGITAL HAIRDRYER COLOUR BLACK, WHITE OR SILVER, DIRECT VENTILATION, BASE COD. BP21, WITH BLACK BASE AND TUBE.
- CASQUE DIGITAL COULEUR BLANC, NOIR OU SILVER, VENTILATION DIRECTE, PIED COD. BP21, AVEC BASE ET TUBE NOIRES.
- DIGITALER HAARTROCKEN WEISS, SCHWARZ ODER SILBER, DIREKTBELÜFTUNG, FUSS COD. BP21, SCHWARZER FUSS UND SCHLAUCH.

COD. 731.22

- CASCO DIGITALE COLORE BIANCO, NERO O SILVER, VENTILAZIONE DIRETTA, CON BASE COD. BP22, CON PIEDE E TUBO COLORE NERO.
- DIGITAL HAIRDRYER COLOUR BLACK, WHITE OR SILVER, DIRECT VENTILATION, WITH BASE COD. BP22, WITH BLACK BASE AND TUBE.
- CASQUE DIGITAL COULEUR BLANC, NOIR OU SILVER, VENTILATION DIRECTE, AVEC PIED COD. BP22, AVEC BASE ET TUBE NOIRES.
- DIGITALER HAARTROCKEN WEISS, SCHWARZ ODER SILBER, DIREKTBELÜFTUNG, FUSS COD. BP22, SCHWARZER FUSS UND SCHLAUCH.

COD. 731.193

- CASCO DIGITALE COLORE BIANCO, NERO O SILVER, VENTILAZIONE DIRETTA, CON BRACCIO COD. B193 DISPONIBILE IN COLORE BIANCO O NERO CON CUFFIE NERE.
- DIGITAL HAIRDRYER COLOUR BLACK, WHITE OR SILVER, DIRECT VENTILATION, WITH WALL ARM COD. B193 AVAILABLES IN COLOUR WHITE OR BLACK AND BLACK PLASTIC COVERS.
- CASQUE DIGITAL COULEUR BLANC, NOIR OU SILVER, VENTILATION DIRECTE, AVEC BRAS MURAL COD. B193 DISPONIBLE EN COULEUR BLANC OU NOIR ET COUVERTURES EN PLASTIQUE NOIRES.
- DIGITALER HAARTROCKEN WEISS, SCHWARZ ODER SILBER, DIREKTBELÜFTUNG, MIT WANDARM COD. B193 WEISS ODER SCHWARZ, SCHWARZE GELENKABDECKUNGEN.

- SUPPLEMENTO PER BRACCIO B193 COLORE SILVER.
- ADDITIONAL CHARGE FOR SILVER WALL ARM B193.
- SUPPLEMENT POUR BRAS B193 COULEUR SILVER.
- AUFPREIS FÜR ARM FARBE SILBER B193.

FAST

•VOLTAGGIO: 230 V

- VOLTAGE
- VOLTAGE
- SPANNUNG

•POTENZA: 1120 - 1140 W

- POWER
- PUISSANCE
- MACHT

•FREQUENZA: 50/60 HZ

- FREQUENCY
- FREQUENCE
- FREQUENZ

•NR. VELOCITÀ: 1 - 2

- NR. SPEED
- NR. VITESSE
- NR. GESCHWINDIGKEIT

•TIMER: 60'

- TIMER
- TIMER
- TIMER



COD. BP21

- NERO
- BLACK
- NOIR
- SCHWARZ



COD. BP22

- NERO
- BLACK
- NOIR
- SCHWARZ



COD. B193

- NERO
- BLACK
- NOIR
- SCHWARZ



COD. B193

- BIANCO
- WHITE
- BLANC
- WEISS

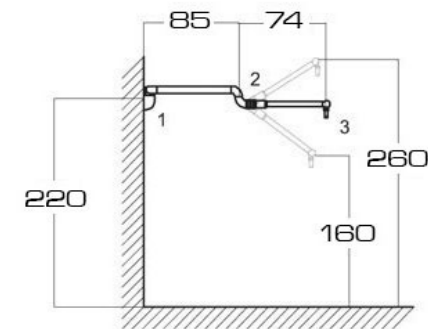
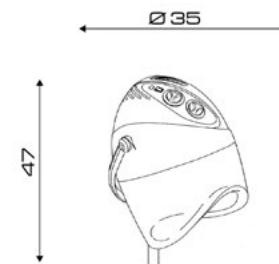

COD. B193

- PRODOTTI
- PRODUCTS
- PRODUITS
- PRODUKTEN

COD. 12.21

- CASCO COLORE BIANCO O NERO, VENTILAZIONE DIRETTA, PIEDE COD. BP21 CON BASE E TUBO NERI.
- HAIRDRYER COLOUR BLACK OR WHITE, DIRECT VENTILATION, FOOT COD. BP21 WITH BLACK BASE AND TUBE.
- CASQUE COULEUR BLANC OU NOIR, VENTILATION DIRECTE, PIED COD. BP21 AVEC BASE ET FUT NOIRS.
- HAARTROCKNER WEISS ODER SCHWARZ, DIREKTBELÜFTUNG, MIT FUSS COD. BP21 SCHWARZER FUSS UND SCHLAUCH.

COD. 12.22

- CASCO COLORE BIANCO O NERO, VENTILAZIONE DIRETTA, PIEDE COD. BP22 CON BASE E TUBO NERI.
- HAIRDRYER COLOUR BLACK OR WHITE, DIRECT VENTILATION, FOOT COD. BP22 WITH BLACK BASE AND TUBE.
- CASQUE COULEUR BLANC OU NOIR, VENTILATION DIRECTE, PIED COD. BP22 AVEC BASE ET FUT NOIRS.
- HAARTROCKNER WEISS ODER SCHWARZ, DIREKTBELÜFTUNG, MIT FUSS COD. BP22 SCHWARZER FUSS UND SCHLAUCH.

COD. 12.193

- CASCO COLORE BIANCO O NERO, VENTILAZIONE DIRETTA, CON BRACCIO A MURO COD. B193 DISPONIBILE IN COLORE BIANCO O NERO E CON CUFFIE NERE.
- HAIRDRYER COLOUR BLACK OR WHITE, DIRECT VENTILATION, WITH WALL ARM COD. 193 AVAILABLES COLOUR WHITE OR BLACK AND COVERING CAPS BLACK.
- CASQUE COULEUR BLANC OU NOIR, VENTILATION DIRECTE, AVEC BRAS MURAL COD. 193 DISPONIBLE EN COULEUR BLANC OU NOIR ET COUVERTURES EN PLASTIQUE NOIRES.
- HAARTROCKNER WEISS ODER SCHWARZ, DIREKTBELÜFTUNG, MIT WANDARM COD. B193 WEISS ODER SCHWARZ, SCHWARZE GELENKABDECKUNGEN.

- ACCESSORI
- ACCESSORIES
- ACCESSOIRES
- ZUBEHÖR

2VEL

- SUPPLEMENTO 2 VELOCITÀ.
- 2 SPEEDS EXTRA CHARGE.
- SUPPLÉMENT 2 VITESSES.
- AUFPREIS FÜR 2 GESCHWINDIGKETTEN.

ESTRELLA

- **VOLTAGGIO: 230 V**

- VOLTAGE
- VOLTAGE
- SPANNUNG

- **POTENZA: 500 W**

- POWER
- PUISSANCE
- MACHT

- **FREQUENZA: 50/60 HZ**

- FREQUENCY
- FRÉQUENCE
- FREQUENZ

- **REGOLATORE DI POTENZA: SI**

- POWER REGULATOR: YES
- RÉGULATEUR DE PUISSANCE : OUI
- LEISTUNGSREGLER: JA

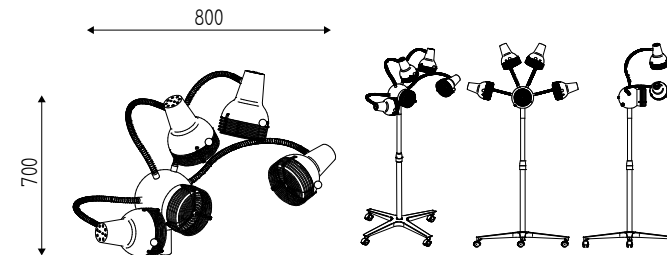

- PRODOTTI
- PRODUCTS
- PRODUITS
- PRODUKTEN

COD. 376.22

- TERMOSTIMOLATORE A INFRAROSSI CON STRUTTURA IN METALLO DORATO E REGOLAZIONE DELL' IRRADIAMENTO, CON BASE BP22 PIEDE E TUBO NERI.
- INFRARED THERMOSTIMULATOR WITH GOLD METAL FRAME AND IRRADIATION ADJUSTMENT, WITH BP22 BASE BLACK FOOT AND TUBE.
- THERMOSTIMOLATEUR A INFRAROUGE AVEC CADRE EN METAL DORE ET REGLAGE DE L'IRRADIATION, AVEC PIED BP22 PIED ET FUT NOIRS.
- INFRAROT-TROCKENGERATE MIT GOLDFARBENEM METALLRAHMEN UND STRAHLUNGSEINSTELLUNG, MIT FUSS BP22 SCHWARZER FUSS UND SCHLAUCH.

BLACK MOON

•VOLTAGGIO: 230 V

- VOLTAGE
- VOLTAGE
- SPANNUNG

•POTENZA: 1120 - 1400 W

- POWER
- PUISSANCE
- MACHT

•FREQUENZA: 50/60 HZ

- FREQUENCY
- FRÉQUENCE
- FREQUENZ

•NR. VELOCITÀ: 2

- NR. SPEED
- NR. VITESSE
- NR. GESCHWINDIGKEIT

•TIMER: 60'

- TIMER
- TIMER
- TIMER



COD. BP22

- NERO
- BLACK
- NOIR
- SCHWARZ



COD. BP11

- NERO
- BLACK
- NOIR
- SCHWARZ



COD. B194

- NERO
- BLACK
- NOIR
- SCHWARZ

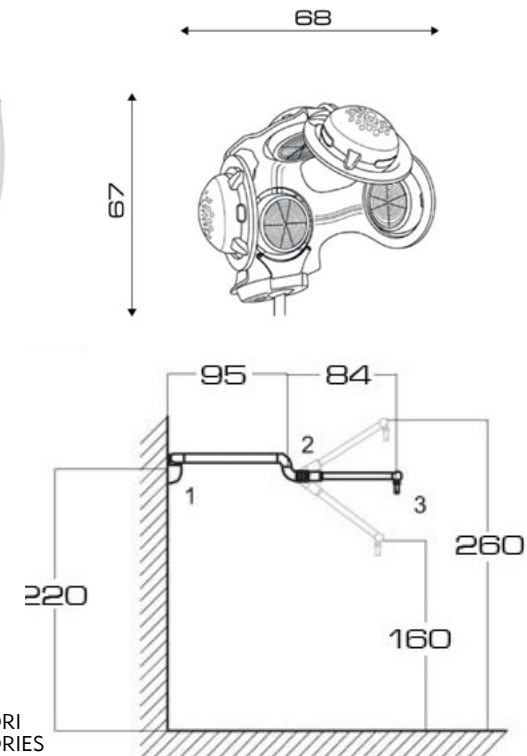

- ACCESSORI
- ACCESSORIES
- ACCESSOIRES
- ZUBEHÖR

- PRODOTTI
- PRODUCTS
- PRODUITS
- PRODUKTEN

COD. 735B.22 • TERMOSTIMOLATORE VENTILATO DOTATO DI 5 LUCI AL QUARZO REGOLAZIONE MANUALE, PLEXIGLASS SATINATO, CALOTTE NERE, PIEDE COD. BP22 CON BASE E TUBO NERI.
 • BREEZY THERMOSTIMULATOR WITH 5 QUARTZ LIGHTS, MANUAL SETTING, MATT PLEXIGLASS, BLACK CAPS, FOOT COD. BP22 WITH BLACK BASE AND TUBE.
 • THERMOSTIMOLATEUR VENTILE' AVEC 5 LUMIERES AU QUARTZ, REGLAGE MANUEL, PLEXIGLASS SATINÉ, CALOTTES COULEUR NOIR, PIED COD. BP22 AVEC BASE ET FUT NOIRS.
 • TROCKENGERÄTE BELÜFTET MIT 5 QUARZLEUCHTEN, MANUELLE VERSTELLUNG, SATINIERTES PLEXIGLASS, SCHWARZE KAPPEN, MIT FUSS COD. BP22 SCHWARZER FUSS UND SCHLAUCH.

COD. 735B.11 • TERMOSTIMOLATORE VENTILATO DOTATO DI 5 LUCI AL QUARZO, REGOLAZIONE MANUALE, PLEXIGLASS SATINATO, CALOTTE SILVER, PIEDE COD. BP11 CON BASE E TUBO NERI.
 • BREEZY THERMOSTIMULATOR WITH 5 QUARTZ LIGHTS, MANUAL SETTING, MATT PLEXIGLASS, BLACK CAPS, FOOT COD. BP11 WITH BLACK BASE AND TUBE.
 • THERMOSTIMOLATEUR VENTILE' AVEC 5 LUMIERES AU QUARTZ, REGLAGE MANUEL, PLEXIGLASS SATINÉ, CALOTTES COULEUR NOIR, PIED COD. BP11 AVEC BASE ET FUT NOIRS.
 • TROCKENGERÄTE BELÜFTET MIT 5 QUARZLEUCHTEN, MANUELLE VERSTELLUNG, SATINIERTES PLEXIGLASS, SCHWARZE KAPPEN, MIT FUSS COD. BP11 SCHWARZER FUSS UND SCHLAUCH.

COD. 735B.194 • TERMOSTIMOLATORE VENTILATO DOTATO DI 5 LUCI AL QUARZO, REGOLAZIONE MANUALE, PLEXIGLASS SATINATO, CALOTTE NERE, BRACCIO A MURO COD. B194 COLORE NERO E CUFFIE NERE.
 • BREEZY THERMOSTIMULATOR WITH 5 QUARTZ LIGHTS, MANUAL SETTING, TRANSPARENT PLEXIGLASS, BLACK CAPS, WALL ARM COD. B194 BLACK COLOUR AND BLACK COVERS.
 • THERMOSTIMOLATEUR VENTILE' AVEC 5 LUMIERES AU QUARTZ, REGLAGE MANUEL, PLEXIGLASS SATINÉ, CALOTTES COULEUR NOIR, BRAS MURAL COD. B194 COULEUR NOIR ET COUVERTURES PLASTIQUES NOIRES.
 • TROCKENGERÄTE BELÜFTET MIT 5 QUARZLEUCHTEN, MANUELLE VERSTELLUNG, SATINIERTES PLEXIGLASS, SCHWARZE KAPPEN, MIT ARM COD. B194 SCHWARZE, SCHWARZE GELENKABDECKUNGEN.

- SUPPLEMENTO PER STRUTTURA PLEXIGLASS COLOR FUMÉ O TRASPARENTE.
- ADDITIONAL CHARGE FOR SMOOKY OR TRANSPARENT PLEXIGLASS STRUCTURE.
- SUPPLEMENT POUR STRUCTURE PLEXIGLASS COULEUR GRIS FONCÉ OU TRANSPARENT.
- AUFFREIS FÜR FABRE FUMÉ ODER TRANSPARENT PLEXIGLASS STRUKTUR.

BLACK MOON DIGIT

- **VOLTAGGIO: 230 V**
- VOLTAGE
- VOLTAGE
- SPANNUNG

- **POTENZA: 1120 - 1400 W**
- POWER
- PUISSANCE
- MACHT

- **FREQUENZA: 50/60 HZ**
- FREQUENCY
- FREQUENCE
- FREQUENZ

- **NR. VELOCITÀ: 3**
- NR. SPEED
- NR. VITESSE
- NR. GESCHWINDIGKEIT

- **NR. PROGRAMMI: 12 + 1 LIBERO**
- NR. SETTINGS: 12 + 1 FREE
- NR. DE RÉGLAGES : 12 + 1 LIBRE
- ZAHL DER EINSTELLUNGEN: 12 + 1 FREI

- **TIMER: 99'**
- TIMER
- TIMER
- TIMER



COD. BP22

- NERO
- BLACK
- NOIR
- SCHWARZ



COD. BP11

- NERO
- BLACK
- NOIR
- SCHWARZ



COD. B194

- NERO
- BLACK
- NOIR
- SCHWARZ

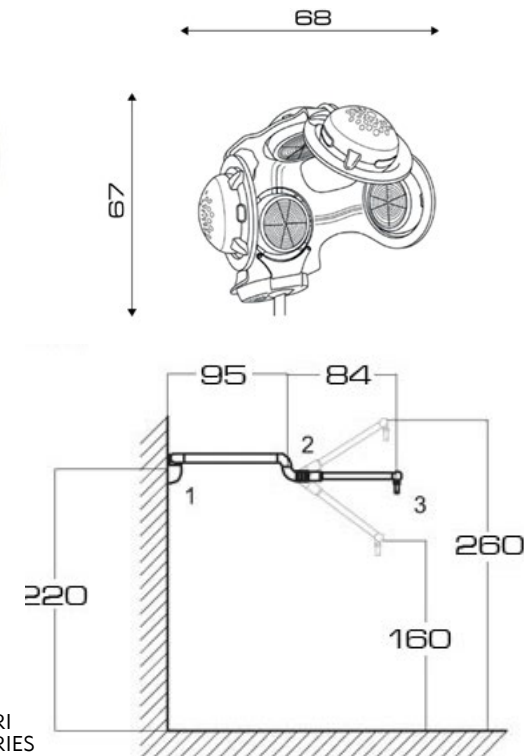

- ACCESSORI
- ACCESSORIES
- ACCESSOIRES
- ZUBEHÖR

- PRODOTTI
- PRODUCTS
- PRODUITS
- PRODUKTEN

- COD. 736B.22**
- TERMOSTIMOLATORE VENTILATO DOTATO DI 5 LUCI AL QUARZO, REGOLAZIONE DIGITALE, PLEXIGLAS SATINATO, CALOTTE NERE, PIEDE COD. BP22 CON BASE E TUBO NERI.
 - BREEZY THERMOSTIMULATOR WITH 5 QUARTZ LIGHTS, DIGITAL SETTING, MATT PLEXIGLASS, BLACK CAPS, FOOT COD. BP22 WITH BLACK BASE AND TUBE.
 - THERMOSTIMULATEUR VENTILE' AVEC 5 LUMIERES AU QUARTZ, REGLAGE DIGITAL, PLEXIGLASS SATINÉ, CALOTTES COULEUR NOIR, PIED COD. BP22 AVEC BASE ET FUT NOIRS.
 - TROCKENGERÄTE BELÜFTET MIT 5 QUARZLEUCHTEN, DIGITAL VERSTELLUNG, SATINIERTES PLEXIGLAS, SCHWARZE KAPPEN, MIT FUSS COD. BP22 SCHWARZER FUSS UND SCHLAUCH.

- COD. 736B.11**
- TERMOSTIMOLATORE VENTILATO DOTATO DI 5 LUCI AL QUARZO, REGOLAZIONE DIGITALE, PLEXIGLAS SATINATO, CALOTTE NERE, PIEDE COD. BP11 CON BASE E TUBO NERI.
 - BREEZY THERMOSTIMULATOR WITH 5 QUARTZ LIGHTS, DIGITAL SETTING, MATT PLEXIGLASS, BLACK CAPS, FOOT COD. BP11 WITH BLACK BASE AND TUBE.
 - THERMOSTIMULATEUR VENTILE' AVEC 5 LUMIERES AU QUARTZ, REGLAGE DIGITAL, PLEXIGLASS SATINÉ, CALOTTES COULEUR NOIR, PIED COD. BP11 AVEC BASE ET FUT NOIRS.
 - TROCKENGERÄTE BELÜFTET MIT 5 QUARZLEUCHTEN, DIGITAL VERSTELLUNG, SATINIERTES PLEXIGLAS. SCHWARZE KAPPEN. MIT FUSS BP11 SCHWARZER FUSS UND SCHLAUCH

- COD. 736B.194**
- TERMOSTIMOLATORE SPACE DIGIT VENTILATA DOTATA DI 5 LUCI AL QUARZO, REGOLAZIONE DIGITALE, PLEXIGLAS SATINATO, CALOTTE NERE, BRACCIO A MURO COD. B194 COLORE NERO E CUFFIE NERE.
 - BREEZY THERMOSTIMULATOR WITH 5 QUARTZ LIGHTS, DIGITAL SETTING, MATT PLEXIGLASS, BLACK CAPS, WALL ARM COD. B194 BLACK COLOUR AND BLACK COVERS.
 - THERMOSTIMULATEUR VENTILE' AVEC 5 LUMIERES AU QUARTZ, REGLAGE DIGITAL, PLEXIGLASS SATINÉ, CALOTTES COULEUR NOIR, BRAS MURAL COD. B194 COULEUR NOIR ET COUVERTURES PLASTIQUES NOIRES.
 - TROCKENGERÄTE BELÜFTET MIT 5 QUARZLEUCHTEN, DIGITAL VERSTELLUNG, SATINIERTES PLEXIGLAS, SCHWARZE KAPPEN. MIT ARM COD. B194 SCHWARZE, SCHWARZER KOPFHÖRER.

- SUPPLEMENTO PER STRUTTURA PLEXIGLAS COLOR FUMÉ O TRASPARENTE.
- ADDITIONAL CHARGE FOR SMOOKY OR TRANSPARENT PLEXIGLASS STRUCTURE.
- SUPPLEMENT POUR STRUCTURE PLEXIGLAS COULEUR GRIS FONCÉ OU TRANSPARENT.
- AUFPREIS FÜR FABRE FUMÉ ODER TRANSPARENT PLEXIGLAS STRUKTUR.

MOON

•VOLTAGGIO: 230 V

- VOLTAGE
- VOLTAGE
- SPANNUNG

•POTENZA: 1120 - 1400 W

- POWER
- PUISSANCE
- MACHT

•FREQUENZA: 50/60 HZ

- FREQUENCY
- FRÉQUENCE
- FREQUENZ

•NR. VELOCITÀ: 2

- NR. SPEED
- NR. VITESSE
- NR. GESCHWINDIGKEIT

•TIMER: 60'

- TIMER
- TIMER
- TIMER



COD. BP22

- NERO
- BLACK
- NOIR
- SCHWARZ



COD. BP11

- NERO
- BLACK
- NOIR
- SCHWARZ



COD. B194

- SILVER
- SILVER
- SILVER
- SILBER



COD. 735.22

- + •CALOTTE ANTRACITE
- DARK GRAY CAPS
- CALOTTES GRIS FONCÉ.
- ANTHRAZIT KAPPEN

INSTALLAZIONE / INSTALLATION
INSTALLATION / INSTALLATION

68

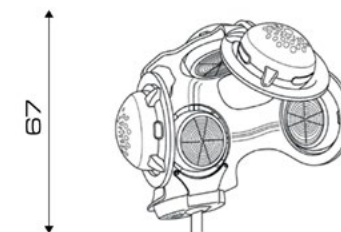

67

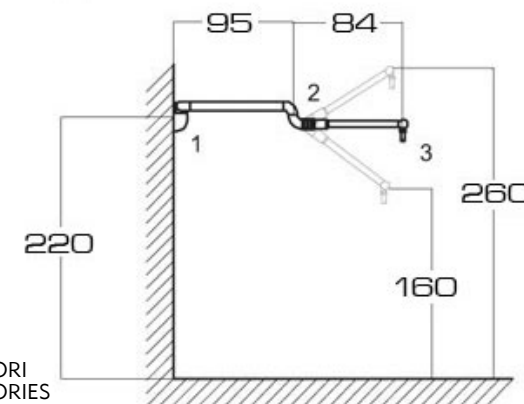

- ACCESSORI
- ACCESSORIES
- ACCESSOIRES
- ZUBEHÖR

- PRODOTTI
- PRODUCTS
- PRODUITS
- PRODUKTEN

- COD. 735.22**
- TERMOSTIMOLATORE VENTILATO DOTATO DI 5 LUCI AL QUARZO REGOLAZIONE MANUALE, PLEXIGLASS TRASPARENTE O SATINATO, CALOTTE SILVER, PIEDE COD. BP22 CON BASE E TUBO NERI.
 - BREEZY THERMOSTIMULATOR WITH 5 QUARTZ LIGHTS, MANUAL SETTING, TRANSPARENT OR MATT PLEXIGLASS, SILVER CAPS AND BASE COD. BP22 BLACK BASE AND TUBE.
 - THERMOSTIMOLATEUR VENTILE' AVEC 5 LUMIERES AU QUARTZ, REGLAGE MANUEL, PLEXIGLASS TRANSPARENT OU SATINE', CALOTTES SILVER, PIED COD. BP22 AVEC BASE ET FUT NOIRS.
 - TROCKENGERÄTE BELÜFTET MIT 5 QUARZLEUCHTEN MANUELLE VERSTELLUNG TRANSPARENTES ODER SATINIERTES PLEXIGLAS. SILBERE KAPPEN. MIT FUSS COD. BP22 SCHWARZER FUSS UND SCHLAUCH

- COD. 735.11**
- TERMOSTIMOLATORE VENTILATO DOTATO DI 5 LUCI AL QUARZO REGOLAZIONE MANUALE, PLEXIGLASS TRASPARENTE O SATINATO, CALOTTE SILVER, PIEDE COD. BP11 CON BASE E TUBO NERI.
 - BREEZY THERMOSTIMULATOR WITH 5 QUARTZ LIGHTS, MANUAL SETTING, TRANSPARENT OR MATT PLEXIGLASS, SILVER CAPS AND BASE COD. BP11 BLACK BASE AND TUBE.
 - THERMOSTIMOLATEUR VENTILE' AVEC 5 LUMIERES AU QUARTZ, REGLAGE MANUEL, PLEXIGLASS TRANSPARENT OU SATINE', CALOTTES SILVER, PIED COD. BP11 AVEC BASE ET FUT NOIRS.
 - TROCKENGERÄTE BELÜFTET MIT 5 QUARZLEUCHTEN MANUELLE VERSTELLUNG TRANSPARENTES ODER SATINIERTES PLEXIGLAS. SILBERE KAPPEN. MIT FUSS COD. BP11 SCHWARZER FUSS UND SCHLAUCH.

- COD. 735.194**
- TERMOSTIMOLATORE VENTILATO DOTATO DI 5 LUCI AL QUARZO REGOLAZIONE MANUALE, PLEXIGLASS TRASPARENTE O SATINATO, CALOTTE SILVER, CON BRACCIO COD. B194 SILVER CON CUFFIE NERE.
 - BREEZY THERMOSTIMULATOR WITH 5 QUARTZ LIGHTS, MANUAL SETTING, TRANSPARENT OR MATT PLEXIGLASS, SILVER CAPS AND WALL ARM COD. B194 COLOUR SILVER AND BLACK COVERS.
 - THERMOSTIMOLATEUR VENTILE' AVEC 5 LUMIERES AU QUARTZ, REGLAGE MANUEL, PLEXIGLASS TRANSPARENT OU SATINE', CALOTTES SILVER. AVEC BRAS COD. B194 ET CAPOTS DE PROTECTION NOIRS.
 - TROCKENGERÄTE BELÜFTET MIT 5 QUARZLEUCHTEN MANUELLE VERSTELLUNG TRANSPARENTES ODER SATINIERTES PLEXIGLAS, SILBERE KAPPEN, MIT ARM COD. B194 SILBERE, SCHWARZE GELENKABDECKUNGEN.

- SUPPLEMENTO PER STRUTTURA PLEXIGLAS COLOR FUMÉ.
- ADDITIONAL CHARGE FOR SMOOKY PLEXIGLASS STRUCTURE COLOUR.
- SUPPLEMENT POUR STRUCTURE PLEXIGLAS COULEUR GRIS FONCÉ.
- AUFPREIS FÜR FABRE FUMÉ PLEXIGLAS STRUKTUR.

- SUPPLEMENTO CALOTTE COLOR ANTRACITE.
- ADDITIONAL CHARGE FOR DARK GREY CAPS COLOUR.
- SUPPLEMENT POUR CALOTTES COULEUR GRIS FONCÉ.
- AUFPREIS FÜR ANTHRAZIT KAPPEN.

- SUPPLEMENTO PER BRACCIO B194 COLORE ANTRACITE.
- ADDITIONAL CHARGE FOR DARK GREY WALL ARM B194 COLOUR.
- SUPPLEMENT POUR BRAS B194 COULEUR GRIS FONCÉ.
- AUFPREIS FÜR ANTHRAZIT ARM B194.

MOON DIGIT

•VOLTAGGIO: 230 V

- VOLTAGE
- VOLTAGE
- SPANNUNG

•POTENZA: 1120 - 1400 W

- POWER
- PUISSANCE
- MACHT

•FREQUENZA: 50/60 HZ

- FREQUENCY
- FRÉQUENCE
- FREQUENZ

•NR. VELOCITÀ: 3

- NR. SPEED
- NR. VITESSE
- NR. GESCHWINDIGKEIT

•NR. PROGRAMMI: 12 + 1 LIBERO

- NR. SETTINGS: 12 + 1 FREE
- NR. DE RÉGLAGES : 12 + 1 LIBRE
- ZAHL DER EINSTELLUNGEN: 12 + 1 FREI

•TIMER: 99'

- TIMER
- TIMER
- TIMER

- PRODOTTI
- PRODUCTS
- PRODUITS
- PRODUKTEN



COD. BP22

- NERO
- BLACK
- NOIR
- SCHWARZ



COD. BP11

- NERO
- BLACK
- NOIR
- SCHWARZ



COD. B194

- GRIGIO
- GREY
- GRIS
- GRAU



COD. 736.11

INSTALLAZIONE / INSTALLATION
INSTALLATION / INSTALLATION

68

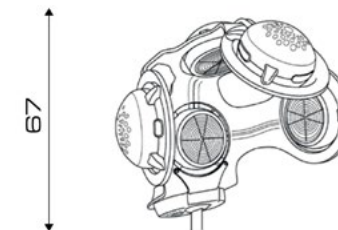

67

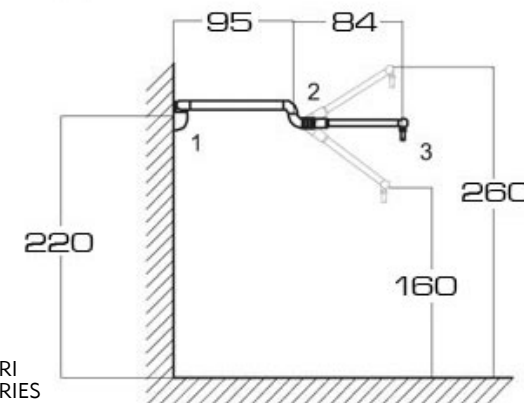

- ACCESSORI
- ACCESSORIES
- ACCESSOIRES
- ZUBEHÖR

- COD. 736.22**
- TERMOSTIMOLATORE VENTILATO DOTATO DI 5 LUCI AL QUARZO, REGOLAZIONE DIGITALE, PLEXIGLASS TRASPARENTE O SATINATO, CALOTTE SILVER, PIEDE COD. BP22 CON BASE E TUBO NERI.
 - BREEZY THERMOSTIMULATOR WITH 5 QUARTZ LIGHTS, DIGITAL SETTING, TRANSPARENT OR MATT PLEXIGLASS, SILVER CAPS, BASE COD. BP22 WITH BLACK FOOT AND TUBE.
 - THERMOSTIMULATEUR VENTILE' AVEC 5 LUMIERES AU QUARTZ, REGLAGE DIGITAL, PLEXIGLASS TRANSPARENT OU SATINE', CALOTTES SILVER, PIED COD. BP22 AVEC BASE ET FUT NOIRS.
 - TROCKENGERÄTE BELÜFTET MIT 5 QUARZLEUCHTEN, DIGITAL VERSTELLUNG, TRANSPARENTES ODER SATINIERTES PLEXIGLAS, SILBERE KAPPEN MIT FUSS COD. BP22 SCHWARZER FUSS UND SCHLAUCH.

- COD. 736.11**
- TERMOSTIMOLATORE VENTILATO DOTATO DI 5 LUCI AL QUARZO, REGOLAZIONE DIGITALE, PLEXIGLAS TRASPARENTE O SATINATO, CALOTTE SILVER, PIEDE COD. BP11 CON BASE E TUBO NERI.
 - BREEZY THERMOSTIMULATOR WITH 5 QUARTZ LIGHTS, DIGITAL SETTING, TRANSPARENT OR MATT PLEXIGLASS, SILVER CAPS, BASE COD. BP11 WITH BLACK FOOT AND TUBE.
 - THERMOSTIMULATEUR VENTILE' AVEC 5 LUMIERES AU QUARTZ, REGLAGE DIGITAL, PLEXIGLASS TRANSPARENT OU SATINE', CALOTTES SILVER, PIED COD. BP11 AVEC BASE ET FUT NOIRS.
 - TROCKENGERÄTE BELÜFTET MIT 5 QUARZLEUCHTEN, DIGITAL VERSTELLUNG, TRANSPARENTES ODER SATINIERTES PLEXIGLAS, SILBERE KAPPEN MIT FUSS COD. BP11 SCHWARZER FUSS UND SCHLAUCH.

- COD. 736.194**
- TERMOSTIMOLATORE VENTILATO DOTATO DI 5 LUCI AL QUARZO REGOLAZIONE DIGITALE, PLEXIGLAS TRASPARENTE O SATINATO, CALOTTE SILVER, CON BRACCIO COD. B194 SILVER E CUFFIE NERE.
 - BREEZY THERMOSTIMULATOR WITH 5 QUARTZ LIGHTS, DIGITAL SETTING, TRANSPARENT OR MATT PLEXIGLASS, SILVER CAPS, WALL ARM COD. B194 SILVER AND BLACK COVERS.
 - THERMOSTIMULATEUR VENTILE' AVEC 5 LUMIERES AU QUARTZ, REGLAGE DIGITAL, PLEXIGLASS TRANSPARENT OU SATINE', CALOTTES SILVER, BRAS MURALE COD. B194 CAPOTS DE PROTECTION NOIRS.
 - TROCKENGERÄTE MOON BELÜFTET MIT 5 QUARZLEUCHTEN DIGITAL VERSTELLUNG TRANSPARENTES ODER SATINIERTES PLEXIGLAS. SILBERE KAPPEN. MIT ARM COD. B194 SILBERE, SCHWARZE GELENKABDECKUNGEN.

- SUPPLEMENTO PER STRUTTURA FUMEE'
- ADDITIONAL CHARGE FOR SMOOKY STRUCTURE.
- SUPPLEMENT POUR STRUCTURE FUMÉE.
- AUFPREIS FÜR FUME' STRUKTUR.

- SUPPLEMENTO CALOTTE ANTRACITE.
- ADDITIONAL CHARGE FOR DERK GRAY CAPS.
- SUPPLEMENT POUR CALOTTES GRIS FONCÉ.
- AUFPREIS FÜR ANTHRACIT KAPPEN.

- SUPPLEMENTO PER BRACCIO B194 COLORE ANTRACITE.
- ADDITIONAL CHARGE FOR DARK GREY WALL ARM B194.
- SUPPLEMENT POUR BRAS B194 GRIS FONCÉ.
- AUFPREIS FÜR ANTHRACIT ARM B194.

INFRARED EVO



COD. 745-MB



COD. 745-OR



COD. 745-MN

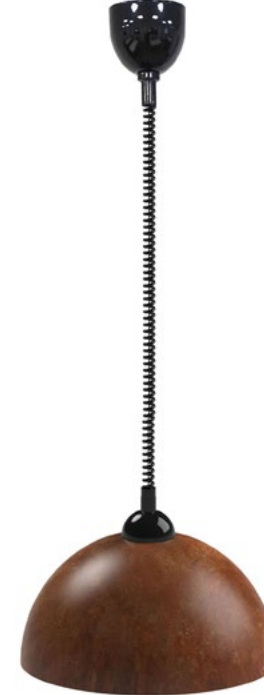

COD. 745-CO

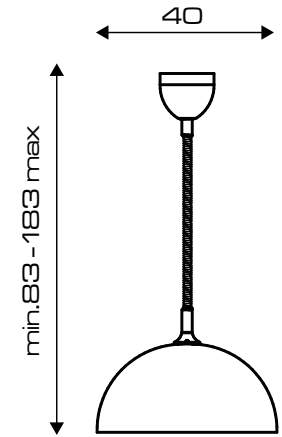

- LAMPADA TERMICA A RAGGI INFRAROSSI CON CAMPANA IN 8 FINITURE
- INFRA RED LAMP THERM WITH BELL IN 8 FINISHING COLOURS
- STIMULATEUR INFRAROUGE THERM AVEC CLOCHE EN 8 COULEURS
- INFRAROTLAMPE MIT LAMPEN GLOCKE IN 8 ENDBEARBEITUNGEN

- BIANCO LUCIDO
- GLOSSY WHITE
- BLANC BRILLANT
- GLÄNZEND WEISS

- ROSSO TRASPARENTE
- TRANSPARENT RED
- ROUGE TRANSPARENT
- TRANSPARENT ROT

- NERO LUCIDO
- GLOSSY BLACK
- NOIR BRILLANT
- GLÄNZEND SCHWARZ

- ORO OPACO
- MATT GOLD
- OR MAT
- MATT GOLD

- RAME OPACO
- MATT COPPER
- CUIVRE MAT
- MATT KUPFER

- MARMO NERO OPACO
- MATT BLACK MARBLE
- MARBRE NOIR MAT
- MATT SCHWARZ MARMOR

- MARMO BIANCO OPACO
- MATT WHITE MARBLE
- MARBRE BLANC MAT
- MATT WEISS MARMOR

- CORTEN
- CORTEN
- CORTEN
- CORTEN



COD. 743-BI



COD. 743-RO



COD. 743-NE



COD. 745-OR



COD. 745-RM



COD. 745-MN



COD. 745-MB



COD. 745-CO

**INSTALLAZIONE ZONA LAVAGGIO - WASH UNIT AREA INSTALLATION
BAC DE LAVAGE INSTALLATION - INSTALLATION WASCHANLAGE ZONE**

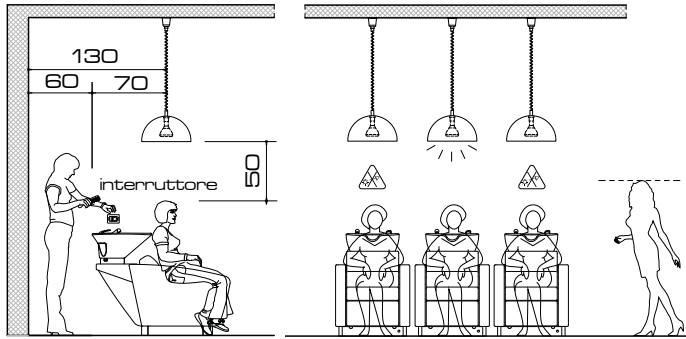

**INSTALLAZIONE ZONA TAGLIO - HAIR CUTTING AREA INSTALLATION
COIFFAGE INSTALLATION - INSTALLATION HAARSCHNITT ZONE**

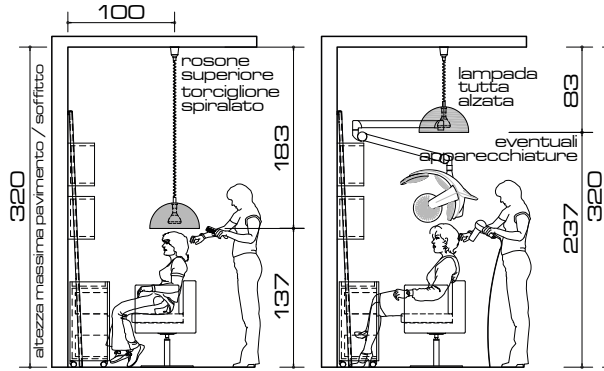

**INSTALLAZIONE ZONA RETRO LAVAGGIO - REAR WASH UNIT AREA INSTALLATION
RETRO BAC DE LAVAGE INSTALLATION - INSTALLATION LABOR ZONE**

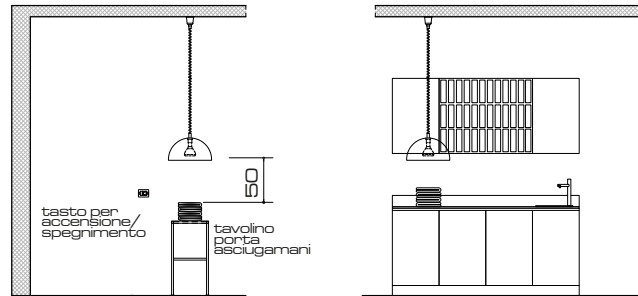

CONTROLLER



- ACCESSORI
- ACCESSORIES
- ACCESSOIRES
- ZUBEHÖR

- COD. 932**
- TELECOMANDO PER INFRARED COMPLETO DI MODULO DI CONTROLLO
 - REMOTE CONTROL FOR INFRARED, COMPLETE WITH CONTROLLER MODULE
 - TÉLÉCOMMANDE POUR INFRARED, COMPLÈTE DE MODULE DE COMMANDE
 - FERNBEDIENUNG FÜR INFRARED MIT STEUERGERÄT



VAPOREON

• **VOLTAGGIO: 230 V**

- VOLTAGE
- VOLTAGE
- SPANNUNG

• **POTENZA: 500 - 510 W**

- POWER
- PUISSANCE
- MACHT

• **FREQUENZA: 50/60 HZ**

- FREQUENCY
- FREQUENCE
- FREQUENZ

• **TIMER: 30'**

- TIMER
- TIMER
- TIMER



COD. 365.21

- PRODOTTI
- PRODUCTS
- PRODUITS
- PRODUKTEN

COD. 365.21

- VAPORIZZATORE COLORE BIANCO O NERO, PIEDE COD. BP21 CON BASE E TUBO NERI.
- STEAMER COLOUR WHITE OR BLACK, FOOT COD. BP21 WITH BLACK BASE AND TUBE.
- VAPORIZATEUR COULEUR BLANC OU NOIR, PIED COD. BP21 AVEC BASE ET FUT NOIRS.
- DAMPFHAUBE WEISS ODER SCHWARZ, MIT FUSS COD. BP21, SCHWARZER FUSS UND SCHLAUCH.

COD. 365.22

- VAPORIZZATORE COLORE BIANCO O NERO, PIEDE COD. BP22 CON BASE E TUBO NERI.
- STEAMER COLOUR WHITE OR BLACK, FOOT COD. BP22 WITH BLACK BASE AND TUBE.
- VAPORIZATEUR COULEUR BLANC OU NOIR, PIED COD. BP22 AVEC BASE ET FUT NOIRS.
- DAMPFHAUBE WEISS ODER SCHWARZ, MIT FUSS COD. BP22, SCHWARZER FUSS UND SCHLAUCH.



COD. 365.22

- ACCESSORI
- ACCESSORIES
- ACCESSOIRES
- ZUBEHÖR

- SUPPLEMENTO VERNICE SILVER
- ADDITIONAL CHARGE FOR SILVER PAINTING
- SUPPLEMENT POUR PEINTURE SILVER
- AUFPREIS FÜR SILBERE LACKIERUNG

- SUPPLEMENTO 110 VOLT
- ADDITIONAL CHARGE FOR 100 VOLT
- SUPPLEMENT POUR 110 VOLT
- AUFPREIS FÜR 110 VOLT

COD. B361

- SUPPLEMENTO DIFFUSORE VISO
- ADDITIONAL CHARGE FOR FACE DIFFUSER
- SUPPLEMENT DIFFUSEUR POUR VISAGE
- AUFPREIS FÜR GESICHTSDIFFUSOR

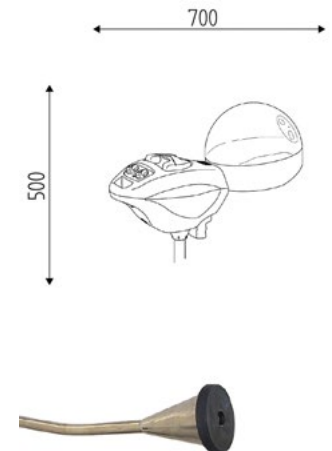

COD. B361

VAPOREON EL

•VOLTAGGIO: 230 V

- VOLTAGE
- VOLTAGE
- SPANNUNG

•POTENZA: 500 - 510 W

- POWER
- PUISSANCE
- MACHT

•FREQUENZA: 50/60 HZ

- FREQUENCY
- FRÉQUENCE
- FREQUENZ

•TIMER: 30'

- TIMER
- TIMER
- TIMER



COD. 375.21

+

- SUPPLEMENTO VERNICE SILVER
- ADDITIONAL CHARGE FOR SILVER PAINTING
- SUPPLEMENT POUR PEINTURE SILVER
- AUFPREIS FÜR SILBERE LACKIERUNG

- PRODOTTI
- PRODUCTS
- PRODUITS
- PRODUKTEN

COD. 375.21

- VAPORIZZATORE COLORE BIANCO O NERO CON REGOLAZIONE ELETTRONICA DEL VAPORE, PIEDE COD. BP21 CON BASE E TUBO NERI.
- STEAMER COLOUR WHITE OR BLACK WITH ELECTRONIC STEAM SETTING, FOOT COD. BP21 WITH BLACK FOOT AND TUBE.
- VAPOREZATEUR BLANC OU NOIR AVEC REGLAGE ELECTRONIQUE DU VAPEUR, PIED COD. BP21 AVEC BASE ET FUT NOIRS.
- DAMPFHAUBE WEISS ODER SCHWARZ MIT ELEKTRONISCHER DAMPFKONTROLLE, MIT FUSS COD. BP21, SCHWARZER FUSS UND SCHLAUCH.

COD. 375.22

- VAPORIZZATORE COLORE BIANCO O NERO CON REGOLAZIONE ELETTRONICA DEL VAPORE, PIEDE COD. BP22 CON BASE E TUBO NERI.
- STEAMER COLOUR WHITE OR BLACK WITH ELECTRONIC STEAM SETTING, FOOT COD. BP22 WITH BLACK FOOT AND TUBE.
- VAPOREZATEUR BLANC OU NOIR AVEC REGLAGE ELECTRONIQUE DU VAPEUR, PIED COD. BP22 AVEC BASE ET FUT NOIRS.
- DAMPFHAUBE WEISS ODER SCHWARZ MIT ELEKTRONISCHER DAMPFKONTROLLE, MIT FUSS COD. BP22, SCHWARZER FUSS UND SCHLAUCH.



COD. 375.22

+

- SUPPLEMENTO VERNICE SILVER
- ADDITIONAL CHARGE FOR SILVER PAINTING
- SUPPLEMENT POUR PEINTURE SILVER
- AUFPREIS FÜR SILBERE LACKIERUNG

- ACCESSORI
- ACCESSORIES
- ACCESSOIRES
- ZUBEHÖR

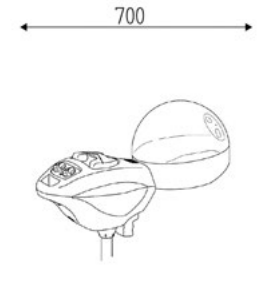

COD. B361

- SUPPLEMENTO VERNICE SILVER
- ADDITIONAL CHARGE FOR SILVER PAINTING
- SUPPLEMENT POUR PEINTURE SILVER
- AUFPREIS FÜR SILBERE LACKIERUNG
- SUPPLEMENTO 110 VOLT
- ADDITIONAL CHARGE FOR 100 VOLT
- SUPPLEMENT POUR 110 VOLT
- AUFPREIS FÜR 110 VOLT

COD. B361

- SUPPLEMENTO DIFFUSORE VISO
- ADDITIONAL CHARGE FOR FACE DIFFUSER
- SUPPLEMENT DIFFUSEUR POUR VISAGE
- AUFPREIS FÜR GESICHTSDIFFUSOR
- SUPPLEMENTO OZONO, SOLO PER COD. 375.2, 375.22
- OZONE ADDITIONAL CHARGE, ONLY FOR COD. 375.21, 375.22
- SUPPLEMENT POUR OZONE, SEULEMENT POUR COD. 375.21, 375.22
- AUFPREIS FÜR OZONE NUR FÜR COD. 375.21, 375.22

HAIRMIST

•VOLTAGGIO: 230 V

- VOLTAGE
- VOLTAGE
- SPANNUNG

•POTENZA: 650 W

- POWER
- PUISSANCE
- MACHT

•FREQUENZA: 50/60 HZ

- FREQUENCY
- FRÉQUENCE
- FREQUENZ

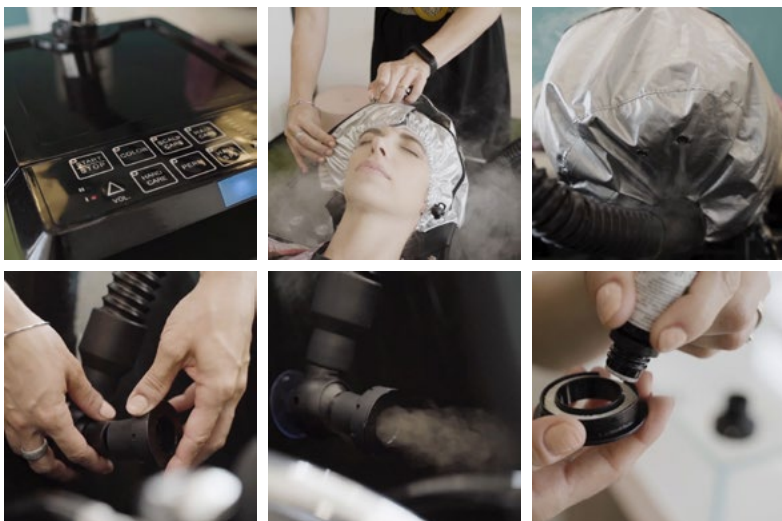

- PRODOTTI
- PRODUCTS
- PRODUITS
- PRODUKTEN

COD. 725

- VAPORIZZATORE A CARRELLO CON STRUTTURA IN ACCIAIO VERNICIATO A POLVERE, CON MANIGLIA DI TRASPORTO E RUOTE PIROETTANTI.
- TROLLEY-MOUNTED STEAMER STEAMER WITH POWDER-COATED STEEL FRAME, WITH CARRYING HANDLE AND SWIVEL WHEELS.
- VAPORISATEUR SUR CHARIOT AVEC STRUCTURE EN ACIER PEINT PAR POUDRE, AVEC POIGNÉE DE TRANSPORT ET ROULETTES PIVOTANTES.
- DAMPFHAUBE AUF ROLLEN MIT PULVERBESCHICHTETEM STAHLRAHMEN, MIT TRAGEGRIF F UND SCHWENK RADEN



- SNODO CON VENTOSA
- ARTICULATION WITH SUCTION CUP
- ARTICULATION AVEC VENTOUSE
- GELENK MIT SAUGNAPP

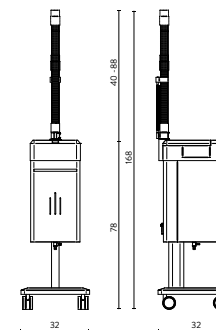

- DIFFUSORE AROMATERAPIA
- AROMATHERAPY DIFFUSER
- DIFFUSEUR D'AROMATHÉRAPIE
- AROMATHERAPIE-DIFFUSOR



- SUPPORTO TUBO ESTENSIBILE
- EXTENSIBLE TUBE HOLDER
- SUPPORT DE TUBE EXTENSIBLE
- STÜTZE FÜR EXTENSIBLE RÖHRE



- FASCIA PER CAPELLI
- HAIR BAND
- BANDEAU
- KOPFBAND



- CUFFIA CON USCITA LATERALE
- CAP WITH LATRAL OUTPUT
- BONNET AVEC SORTIE LATÉRALE
- HAAR KAPPE MIT SEITLICHEM AUSGANG



- CUFFIA CON USCITA FRONTALE
- CAP WITH FRONTAL OUTPUT
- BONNET AVEC SORTIE FRONTALE
- HAAR KAPPE MIT FRONTSEITE AUSGANG



- TUBO ESTENSIBILE
- EXTENSIBLE TUBE
- TUYAU EXTENSIBLE
- AUSZIEHBAREN WELLROHR

- COLORE STANDARD
- STANDARD COLOR
- COULEUR STANDARD
- STANDARD FARBEN



- NERO
- BLACK
- NOIR
- SCHWARZ

CHIC

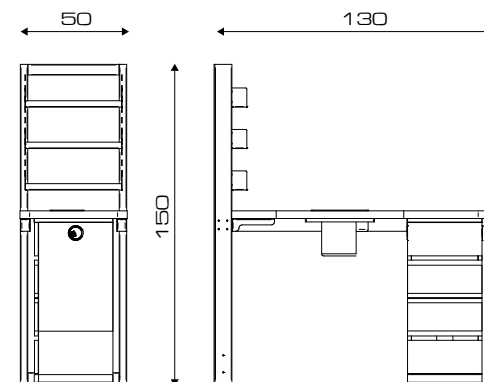

- PRODOTTI
- PRODUCTS
- PRODUITS
- PRODUKTEN

COD. 425

- TAVOLO MANICURE COLORE BIANCO CON ASPIRATORE E POGGIA MANI.
- MANICURE TABLE COLORE WHITE WITH NAIL DUST COLLECTOR AND HAND REST.
- TABLE MANICURE COULEUR BLANC AVEC ASPIRATEUR ET APPUI-MAINS.
- MANIKURTISCH WEISS FARBE MIT ABSAUGUNG UND HANDAUFLAGEN .

LASER

- **VOLTAGGIO: 230 V**

- VOLTAGE
- VOLTAGE
- SPANNUNG

- **POTENZA: 40 W**

- POWER
- PUISSANCE
- MACHT

- **FREQUENZA: 50/60 HZ**

- FREQUENCY
- FREQUENCE
- FREQUENZ

- **UV-C: 9 W**

- UV-C
- UV-C
- UV-C



INSTALLAZIONE / INSTALLATION INSTALLATION / INSTALLATION

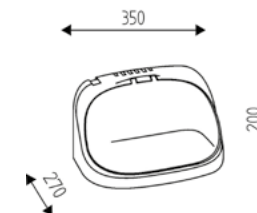

- COLORI
- COLORS
- COULEURS
- FARBEN

- BIANCO
- WHITE
- BLANC
- WEISS



- NERO
- BLACK
- NOIR
- SCHWARZ



- GRIGIO METALLIZATO
- METALLIC GREY
- GRIS MÉTALLIQUE
- METALLIC-GRAU



- PRODOTTI
- PRODUCTS
- PRODUITS
- PRODUKTEN

- IMMAGINE CON UV-C ACCESO.
- IMAGE WITH UV-C LIGHT ON.
- IMAGE AVEC UV-C LAMPE ALLUMÉE.
- BILD MIT UV-C EINGESCHALTET.

COD. 738

- STERILIZZATORE GERMICIDA A RAGGI UV-C, COLORE BIANCO, NERO O GRIGIO METALLIZZATO.
- UV-C RAY STERILIZER, COLOUR WHITE, BLACK OR METALLIC GREY.
- STÉRILISATEUR À RAYONS UV-C COULEUR BLANC, NOIR OU GRIS MÉTALLIQUE.
- KEIMTÖTEND STERILISATOR MIT UV-C LICHT, WEISS, SCHWARZ ODER METALLIC-GRAU.

HOTBOX

- **VOLTAGGIO: 230 V**

- VOLTAGE
- VOLTAGE
- SPANNUNG

- **POTENZA: 200 W**

- POWER
- PUISSANCE
- MACHT

- **FREQUENZA: 50/60 HZ**

- FREQUENCY
- FREQUENCE
- FREQUENZ



INSTALLAZIONE / INSTALLATION
INSTALLATION / INSTALLATION

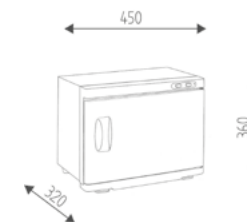

- COLORI
- COLORS
- COULEURS
- FARBEN

- BIANCO
- WHITE
- BLANC
- WEISS



- PRODOTTI
- PRODUCTS
- PRODUITS
- PRODUKTEN

COD. 739

- SCALDASALVIETTE.
- TOWEL HEATER.
- CHAUFFE -SERVIETTES.
- SERVIETTENWÄRMER.

RICAMBI - SPARE PARTS - PIECES DE RECHANGE - ERSATZTEILEN

COD. FP465	<ul style="list-style-type: none"> • MISCELATORE TERMOSTATICO COMPLETO. • COMPLETE THERMOSTATIC MIXER. • MITIGEUR THERMOSTATIQUE COMPLET. • KOMPLETTE TERMOSTATISCHE MISCHBATTERIE. 	COD. M465/2	<ul style="list-style-type: none"> • RUBINETTO CON FORCELLA PER TERMOSTATICO • FORK+ LEVER OPENING/CLOSING FOR THERMOSTATIC MIXER • COURCHE+ LEVIER POUR OUVRIR/FERMER L'EAU POUR MITIGEUR THERMOSTATIQUE. • GABEL UND OFFNUNGS ABSCHNITTS FÜR THERMOSTAT MISCHBATTERIE
COD. C7910050	<ul style="list-style-type: none"> • MISCELATORE CON FORCELLA COMPLETO • COMPLETE WATER MIXER WITH DROP-STOP • MITIGEUR AVEC SYSTEME ANTI-GOUTTE COMPLET • KOMPLETTE MISCHBATTERIE MIT DROP-STOP SYSTEM. 	COD. M519/33	<ul style="list-style-type: none"> • GRIGLIETTA PER PILETTA. • HAIR TRAP • GRILLE POUR LES CHEVEUX. • GITTER FÜR BECKEN.
COD. C7910040	<ul style="list-style-type: none"> • MISCELATORE STANDARD COMPLETO • COMPLETE STANDARD WATER MIXER. • MITIGEUR STANDARD COMPLET • KOMPLETTE STANDARD MISCHBATTERIE. 	COD. M519/28	<ul style="list-style-type: none"> • PILETTA CON GRIGLIETTA PER LAVABO. • DRAIN WITH HAIR TRAP • EVACUATION AVEC GRILLE POUR CUVETTE. • ABFLUSS MIT GITTER FÜR BECKEN.
COD. C7910100	<ul style="list-style-type: none"> • NUOVO MISCELATORE MINIMAL CON FORCELLA - COMPLETO. • COMPLETE NEW MINIMAL WATER MIXER WITH DROP-STOP SYSTEM. • NOUVEAU MITIGEUR MINIMAL AVEC SYSTEME ANTI-GOUTTE - COMPLET. • KOMPLETTE NEU MISCHBATTERIE MINIMAL MIT DROP-STOP SYSTEM. 	COD. M519/29	<ul style="list-style-type: none"> • TUBO DI SCARICO • DRAIN HOSE • TUYAU DE DRAINAGE • SCHLAUCH ABLASSEN
COD. C7910120	<ul style="list-style-type: none"> • NUOVO MISCELATORE MINIMAL STANDARD - COMPLETO. • COMPLETE STANDARD NEW MINIMAL WATER MIXER. • NOUVEAU MITIGEUR MINIMAL STANDARD - COMPLET • KOMPLETTE NEU MISCHBATTERIE MINIMAL STANDARD. 	COD. C9600012	<ul style="list-style-type: none"> • RONDELLA SALVAGOCCIA PER DOCGETTA. • DROP STOP WASHER FOR HANDSHOWER. • RONDELLE ANTI GOUTTE POUR DOUCHETTE. • TROPFENFÄGER UNTERLEGSCHLEIBE FÜR HANDBRAUSE.
COD. C2680020	<ul style="list-style-type: none"> • DOCGETTA CROMATA. • CHROMED SHOWER. • DOUCHETTE CHROMÉE. • VERCROMTE HANDBRAUSE. 	COD. G015000B	<ul style="list-style-type: none"> • LAVELLO H1 BIANCO RICAMBIO SOLO CERAMICA. • WHITE BASIN H1, ONLY CERAMIC. • CUVETTE H1 BLANCHE, SEULEMENT CERAMIQUE. • WEISS BECKEN H1 ERSATZTEIL NUR KERAMIK.
COD. C9550095	<ul style="list-style-type: none"> • TUBO DOCGETTA PVC NERO CM.120 PER MISCELATORE STANDARD. • BLACK PVC SHOWER HOSE CM.120 FOR STANDARD WATER MIXER. • FLEXIBLE DOUCHETTE EN PVC NOIR CM.120 POUR MITIGEUR STANDARD. • HANDBRAUSE ROHR AUS SCHWARZ PVC CM.120 FÜR STANDARD MISCHBATTERIE. 	COD. G015000N	<ul style="list-style-type: none"> • LAVELLO H3 NERO RICAMBIO SOLO CERAMICA. • BLACK BASIN H3, ONLY CERAMIC. • CUVETTE H3 NOIRE, SEULEMENT CERAMIQUE. • SCHWARZ BECKEN H3, ERSATZTEIL NUR KERAMIK.
COD. C9550060	<ul style="list-style-type: none"> • TUBO DOCGETTA PVC NERO CM.50 PER MISCELATORE CON FORCELLA. • BLACK PVC SHOWER HOSE CM.50 FOR DROP-STOP WATER MIXER. • FLEXIBLE DOUCHETTE EN PVC NOIR CM.50 POUR MITIGEUR ANTI-GOUTTE. • HANDBRAUSE ROHR AUS SCHWARZ PVC CM.50 FÜR MISCHBATTERIE MIT DROP-STOP SYSTEM. 	COD. FP422.G1	<ul style="list-style-type: none"> • LAVELLO G1 BIANCO RICAMBIO SOLO CERAMICA. • WHITE BASIN G1, ONLY CERAMIC. • CUVETTE G1 BLANCHE, SEULEMENT CERAMIQUE. • WEISS BECKEN G1, ERSATZTEIL NUR KERAMIK.
COD. M1120/G	<ul style="list-style-type: none"> • CARTUCCIA DI RICAMBIO PER MISCELATORE STANDARD E CON FORCELLA • CARTRIDGE FOR STANDARD AND DROP-STOP MIXER. • CARTOUCHE POUR MITIGEUR STANDARD ET AVEC SYSTEME ANTIGOUTTE. • ERSATZKARTUSCHE FÜR STANDARD MISCHBATTERIE UND MIT DROP-STOP SYSTEM. 	COD. FP422.G3	<ul style="list-style-type: none"> • LAVELLO G3 NERO RICAMBIO SOLO CERAMICA. • BLACK BASIN G3, ONLY CERAMIC. • CUVETTE G3 NOIRE, SEULEMENT CERAMIQUE. • SCHWARZ BECKEN G3, ERSATZTEIL NUR KERAMIK.
COD. M1130/G	<ul style="list-style-type: none"> • CARTUCCIA DI RICAMBIO PER MISCELATORE MINIMAL STANDARD E CON FORCELLA • CARTRIDGE FOR MINIMAL STANDARD AND DROP-STOP MIXER. • CARTOUCHE DE RECHARGE POUR MITIGEUR MINIMAL STANDARD ET ANTIGOUTTE. • ERSATZKARTUSCHE FÜR MINIMAL MISCHBATTERIE STANDARD UND MIT "DROP-STOP" SYSTEM 	COD. G0150340	<ul style="list-style-type: none"> • LAVELLO N1 BIANCO RICAMBIO SOLO CERAMICA. • WHITE BASIN N1, ONLY CERAMIC. • CUVETTE N1 BLANCHE, SEULEMENT CERAMIQUE. • WEISS BECKEN N1, ERSATZTEIL NUR KERAMIK.
COD. M421/5	<ul style="list-style-type: none"> • KIT FORCELLA PORTA DOCGETTA CON TUBO PVC NERO CM.50 (PER CONVERSIONE IN ANTIGOCCIA, NON INCLUDE LA DOCGETTA) • SHOWER HOLDER FORK KIT WITH CM.50 BLACK PVC HOSE (FOR CONVERSION TO DROP-STOP SYSTEM, HANDSHOWER NOT INCLUDED) • KIT FOURCHETTE POUR SUPPORT DOUCHETTE AVEC FLEXIBLE EN PVC NOIR CM.50 (POUR CONVERSION EN ANTI-GOUTTE, DOUCHETTE NON COMPRISE.) • DROP-STOP KIT MIT GABEL UND SCHWARZ PVC 50 CM (KEINE HANDBRAUSE) 	COD. G0150350	<ul style="list-style-type: none"> • LAVELLO N3 NERO RICAMBIO SOLO CERAMICA. • BLACK BASIN N3, ONLY CERAMIC. • CUVETTE N3 NOIRE, SEULEMENT CERAMIQUE. • SCHWARZ BECKEN N3, ERSATZTEIL NUR KERAMIK.

RICAMBI - SPARE PARTS - PIECES DE RECHANGE - ERSATZTEILEN

COD.
G0150210 •LAVELLO BARBER BIANCO COMPLETO.
•COMPLETE WHITE CERAMIC FOR BARBER.
•CUVETTE BLANCHE BARBER COMPLETE.
•KOMPLETT BARBER WEISS BECKEN.

COD.
G0150215 LAVELLO BARBER NERO COMPLETO.
COMPLETE BLACK CERAMIC FOR BARBER.
CUVETTE NOIRE BARBER COMPLETE.
KOMPLETT BARBER SCHWARZ BECKEN.

COD.
S537/4 KIT PULSANTIERA JET MASSAGE.
KIT REMOTE CONTROL JET MASSAGE.
KIT TELECOMMANDE JET MASSAGE.
FERNBEDIENUNG FÜR JET MASSAGE.

COD.
D6220370 BUSTA PVC COPRITELECOMANDO JET MASSAGE.
PVC PROTECTION FOR JET MASSAGE REMOTE CONTROL.
PORTECTION EN PVC POUR TELECOMMANDE JET MASSAGE.
FERNBEDIENUNGBEZUG AUS PVC FÜR JET-MASSAGE.

COD.
C0030010 AERATORI STANDARD PER DOCCETTE (CONFEZIONE DA 4 PEZZI)
STANDARD AERATORS FOR HAND SHOWERS (4-PACK)
AÉRATEURS STANDARD POUR DOUCHETTES (LOT DE 4)
STANDARD-PERLATOREN FÜR HANDBRAUSEN (4ER-PACK)

COD.
C0030030 AERATORI RISPARMIO IDRICO PER DOCCETTE (CONFEZIONE DA 4 PEZZI)
WATER-SAVING AERATORS FOR HAND SHOWERS (PACK OF 4)
AÉRATEURS ÉCONOMISEURS D'EAU POUR DOUCHES À MAIN (PACK DE 4)
WASSERSPARENDE PERLATOREN FÜR HANDBRAUSEN (4ER-PACK)

COD.
C3920040 LAMPADINA DI RICAMBIO INFRARED 100W PAR38.
INFRARED BULB 100W PAR38.
AMPOULE DE RECHANGE INFRARED 100W PAR38.
ERSATZGLÜHBIRNE FÜR INFRARED LAMPE 100W PAR38.

COD.
PSKAI BASIC SKAI AL METRO LINEARE X 1,40 MTH (MULTIPLI DI 1) SERIE BASIC.
SKAI LINEAR METER X 1.40 M HIGH - BASIC COLLECTION.
SKAI AU METRE 1 X 1,40 MTH - BASIC.
SKAI "BASIC" PRO LINEARMETER X 1,40 MT HOCH (MEHRFACH VON 1)

COD.
SKAI SPECIAL SKAI AL METRO LINEARE X 1,40 MTH (MULTIPLI DI 1) SERIE SPECIAL.
SKAI LINEAR METER X 1.40 M HIGH - SPECIAL COLLECTION.
SKAI AU METRE 1 X 1,40 MTH - SPECIAL.
SKAI "SPECIAL" PRO LINEARMETER X 1,40 MT HOCH (MEHRFACH VON 1)

COD.
C5110030 REGOLATORE DI FLUSSO PER RISPARMIO ACQUA
WATER-SAVING FLOW REGULATOR
RÉGULATEUR DE FLUX À ÉCONOMIE D'EAU
WASSERSPARENDE DURCHFLOSSREGLER



COLLEZIONE IMMAGINI

AVAILABLE IMAGES
COLLECTIONS DES IMAGES
BILDER KOLLEKTION



01



02



03



04



05

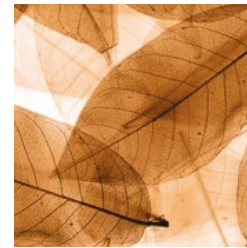

06

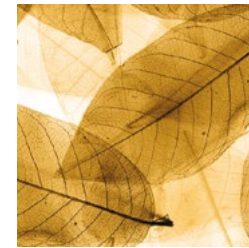

07

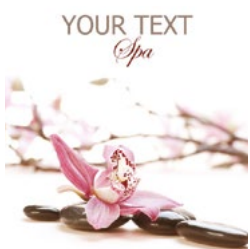

08



09

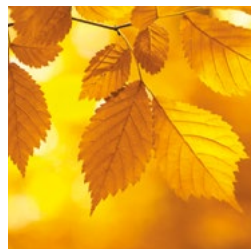

10



11

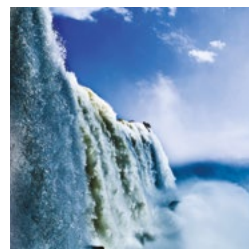

12

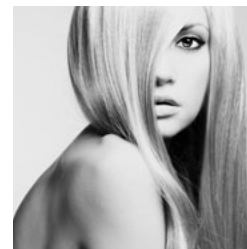

13



14



15

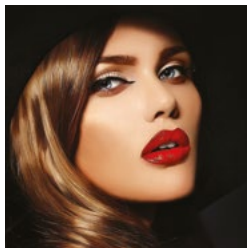

16



17

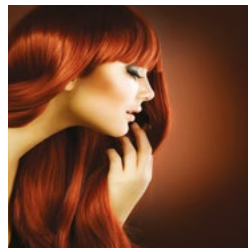

18

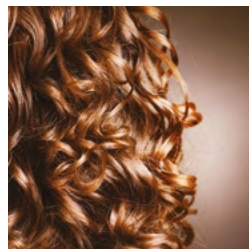

19

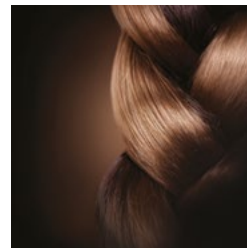

20

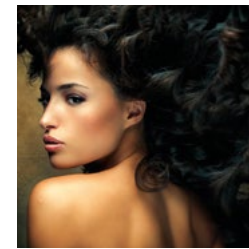

21



22

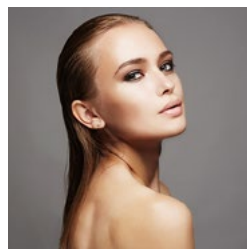

23

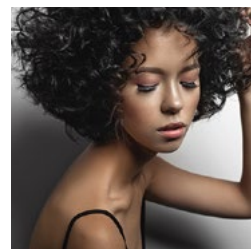

24



25



26



27

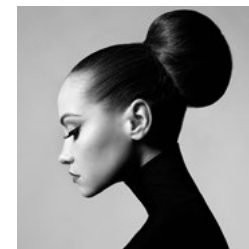

28

COLLEZIONE IMMAGINI

AVAILABLE IMAGES
COLLECTIONS DES IMAGES
BILDER KOLLEKTION



58



59

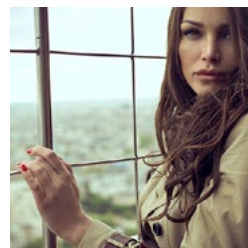

60

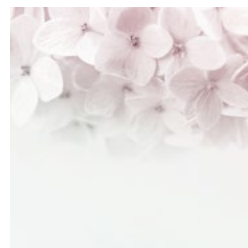

63

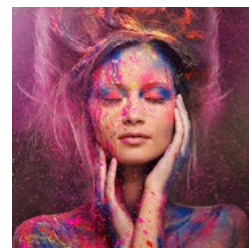

64



65

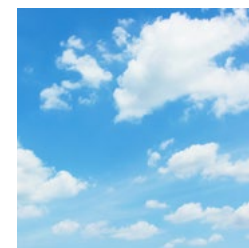

66



67

FINITURE LEGNI

WOOD FINISHING FINITIONS BOIS HOLZBESCHICHTUNGEN



- B
- BIANCO LUCIDO
 - GLOSS WHITE
 - BLANC BRILLANT
 - GLÄNZEND WEISS



- N
- NERO LUCIDO
 - GLOSS BLACK
 - NOIR BRILLANT
 - GLÄNZEND SCHWARZ



- 04
- VINTAGE
 - VINTAGE
 - VINTAGE
 - VINTAGE

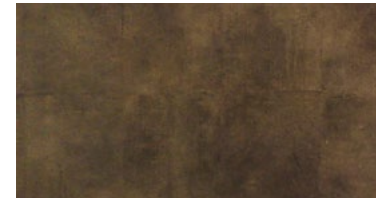

- 08
- BRONZO ANTICO
 - ANTIQUÉ BRONZE
 - BRONZE ANTIQUE
 - ANTIKE BRONZE

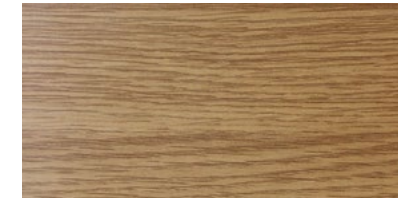

- 11
- OAK
 - OAK
 - CHENE
 - EICHENHOLZ

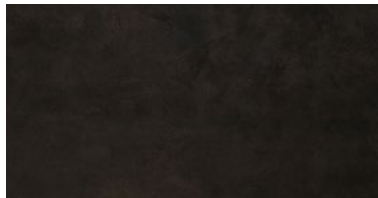

- 12
- VULCANO
 - VOLCANO
 - VOLCAN
 - VULKAN



- 13
- CEMENTO CHIARO
 - LIGHT BETON
 - CIMENT
 - LEICHTER BETON

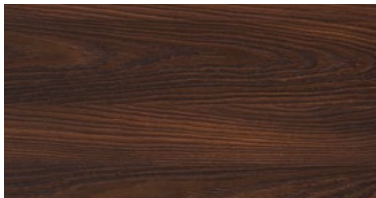

- 14
- OLD JACK
 - OLD JACK
 - OLD JACK
 - OLD JACK



- 15
- MARMO BIANCO
 - WHITE MARBLE
 - MARBRE BLANC
 - WEISSER MARMOR



- 16
- MARMO NERO
 - BLACK MARBLE
 - MARBRE NOIR
 - SCHWARZER MARMOR

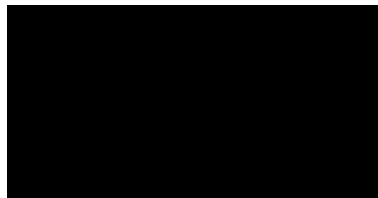

- 17
- NERO OPACO
 - MATT BLACK
 - NOIR MAT
 - MATTSCHWARZ



PULIZIA - CLEANING - NETTOYAGE - REINIGUNG

FINITURE METALLI

METAL FINISHING FINITIONS METAUX METALL BESCHICHTUNGEN

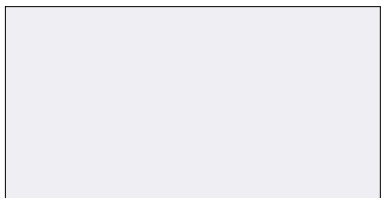

- BIANCO LUCIDO
- GLOSS WHITE
- BLANC BRILLANT
- GLÄNZEND WEISS

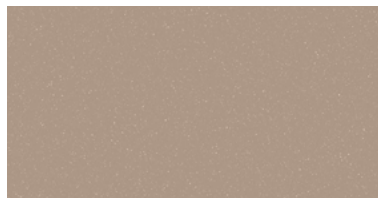

- SABBIA
- SAND
- SABLE
- SAND

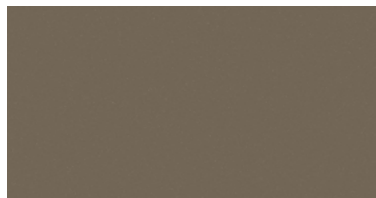

- ARGILLA
- CLAY
- ARGILE
- LEHM

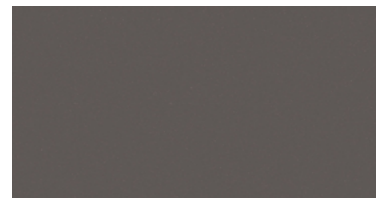

- ARDESIA
- SLATE
- ARDOISE
- SCHIEFER



- NERO OPACO
- MATT BLACK
- NOIR MAT
- MATTSCHWARZ

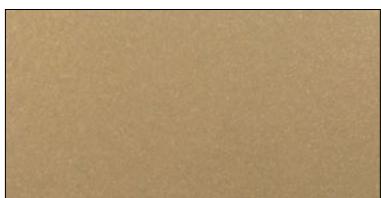

- ORO OPACO
- MATT GOLD
- OR MAT
- GOLD MATT



PULIZIA - CLEANING - NETTOYAGE - REINIGUNG

SKAI BASIC

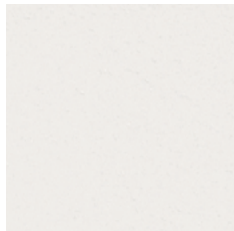

BASIC B 02

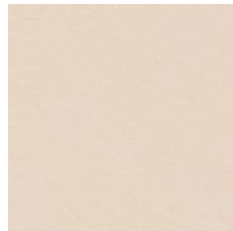

BASIC B 40

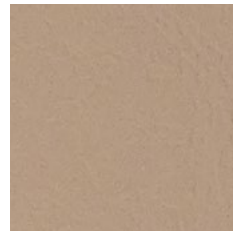

BASIC B 08 

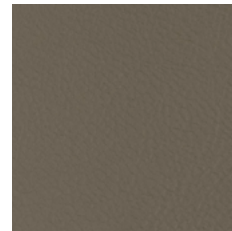

BASIC B 64 

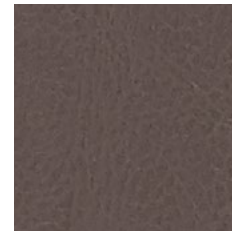

BASIC B 09 



BASIC B 65 

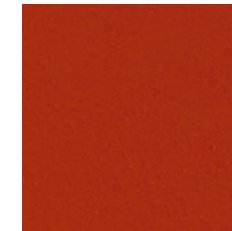

BASIC B 44

BASIC B 05

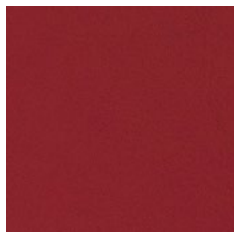

BASIC B 48



BASIC B 12 



BASIC B 49

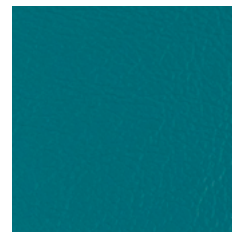

BASIC B 68 

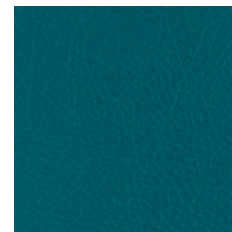

BASIC B 63 

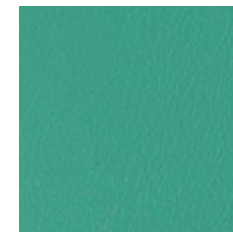

BASIC B 69 

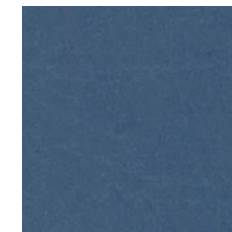

BASIC B 51



BASIC B 45



BASIC B 28

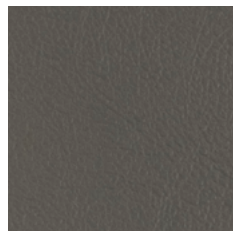

BASIC B 67 

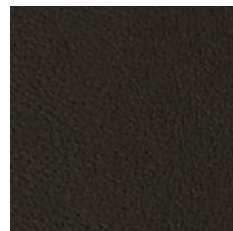

BASIC B 03

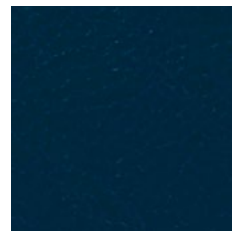

BASIC B 11 



BASIC B 66 

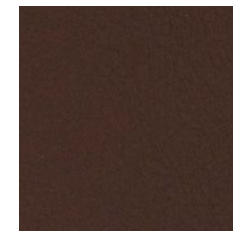

BASIC B 41

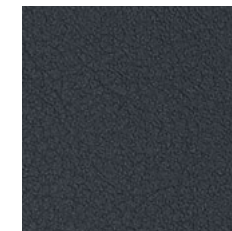

BASIC B 22

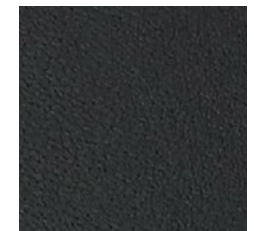

BASIC B 01

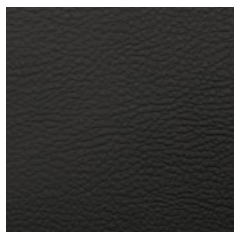

BASIC M 01



- IGNIFUGO
- FIREPROOF
- RÉSISTANT AU FEU
- FEUERFEST



UE Standards
EN1021-1+2



UNI 9175: 2010



[PAG. 42 - EMBOSSING/PER POLTRONE/FOR CHAIRS/
POUR FAUTEUILS/FÜR STHÜLE](#)

[PAG. 95 - EMBOSSING/PER LAVAGGI/FOR WASH UNITS/
POUR BACS DE LAVAGE/FÜR WASCHANLAGEN](#)



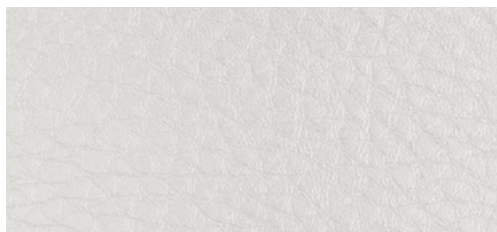

**PULIZIA
CLEANING
NETTOYAGE
REINIGUNG**

SKAI SPECIAL

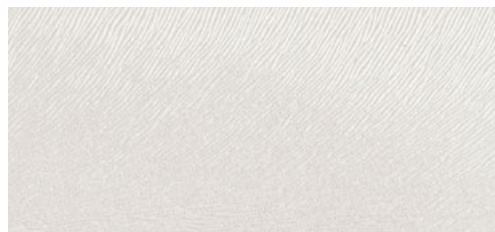

SPECIAL S 13 



SPECIAL S 01 



SPECIAL S 07 

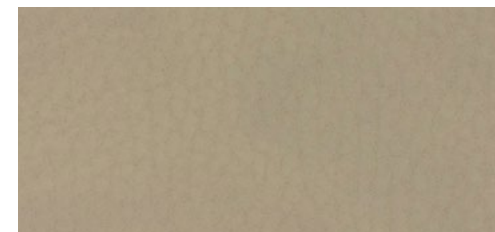

SPECIAL S 91 

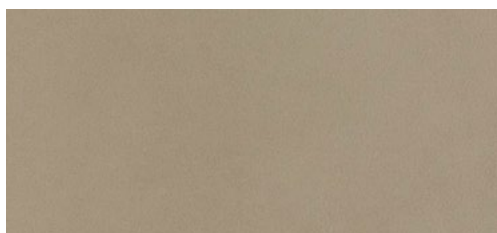

SPECIAL S A5 

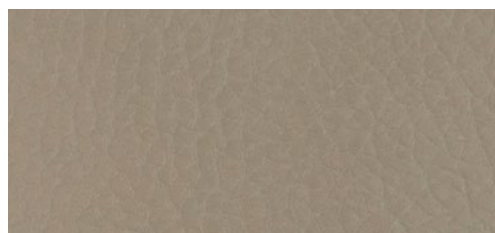

SPECIAL S 49 

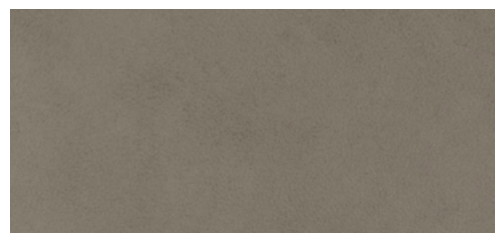

SPECIAL S A4 



SPECIAL S 08 



SPECIAL S 03 

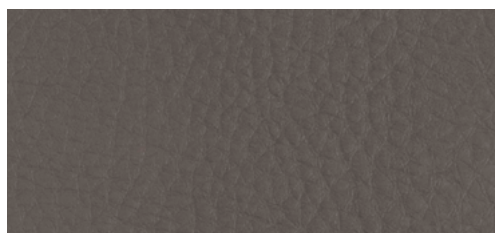

SPECIAL S 48 

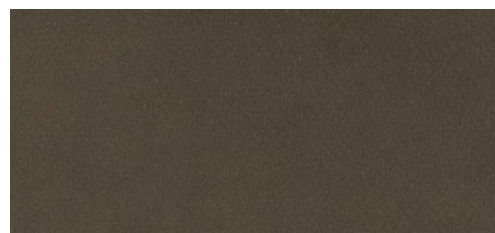

SPECIAL S A1 

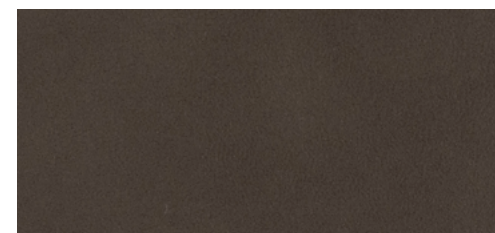

SPECIAL S A7 

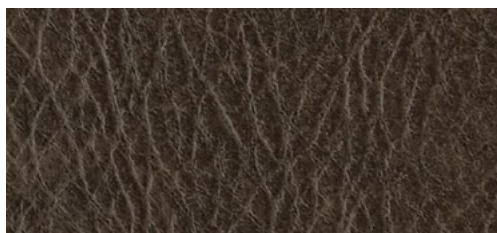

SPECIAL S 09 



SPECIAL S 10 

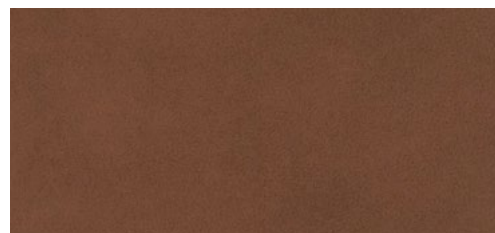

SPECIAL S A8 

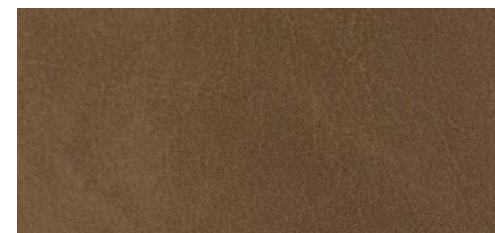

SPECIAL S C1 



UE Standards
EN1021-1+2



UNI 9175: 2010



[PAG. 42 - EMBOSSING/PER POLTRONE/FOR CHAIRS/
POUR FAUTEUILS/FÜR STHÜLE](#)

[PAG. 95 - EMBOSSING/PER LAVAGGI/FOR WASH UNITS/
POUR BACS DE LAVAGE/FÜR WASCHANLAGEN](#)



**PULIZIA
CLEANING
NETTOYAGE
REINIGUNG**

SKAI SPECIAL

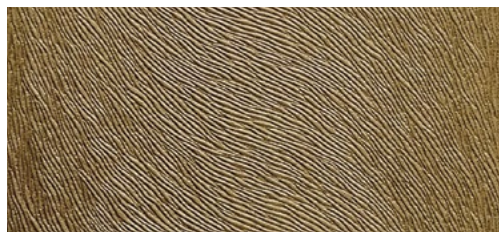

SPECIAL S 06



SPECIAL S B1

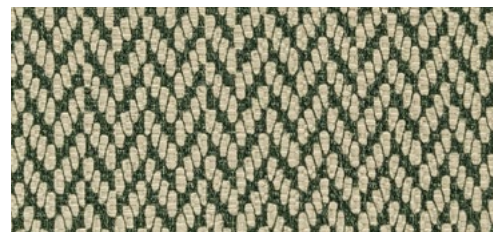

SPECIAL S B2

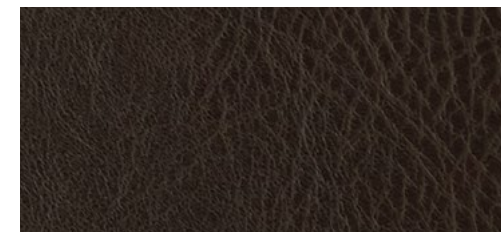

SPECIAL S 11

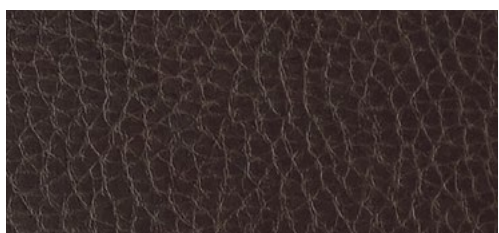

SPECIAL S 17

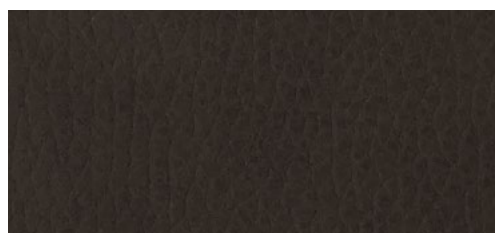

SPECIAL S 38

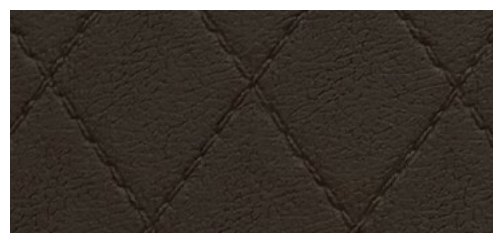

SPECIAL S 29

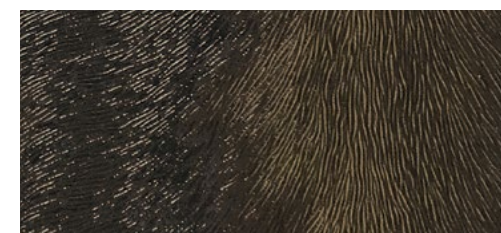

SPECIAL S 05

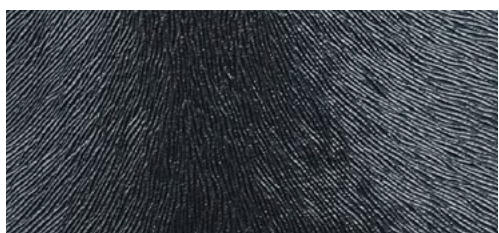

SPECIAL S 04

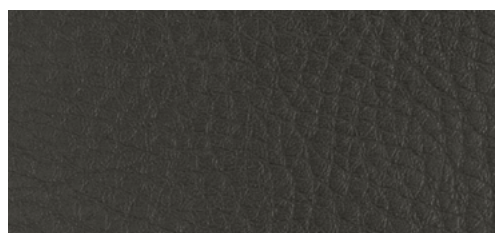

SPECIAL S 46

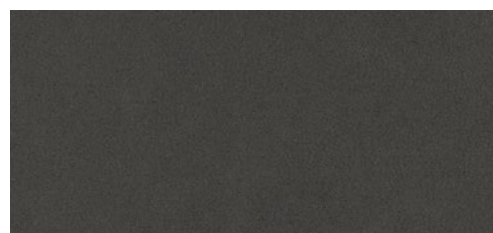

SPECIAL S A6

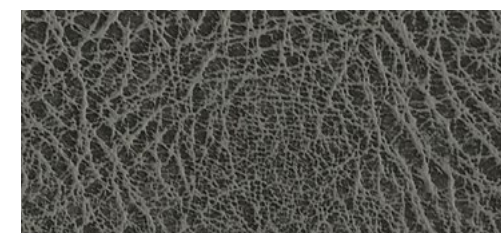

SPECIAL S 31

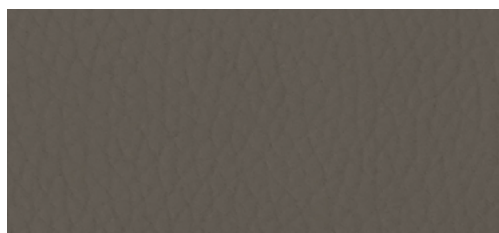

SPECIAL S 37

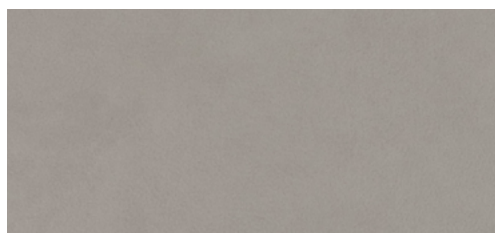

SPECIAL S A2



SPECIAL S 45

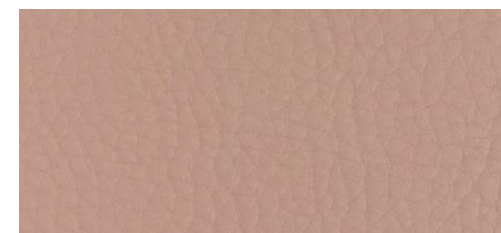

SPECIAL S 50



UE Standards
EN1021-1+2



UNI 9175: 2010



EMBOSSING

[PAG. 42 - EMBOSSING/PER POLTRONE/FOR CHAIRS/
POUR FAUTEUILS/FÜR STHÜLE](#)

[PAG. 95 - EMBOSSING/PER LAVAGGI/FOR WASH UNITS/
POUR BACS DE LAVAGE/FÜR WASCHANLAGEN](#)



**PULIZIA
CLEANING
NETTOYAGE
REINIGUNG**

SKAI SPECIAL

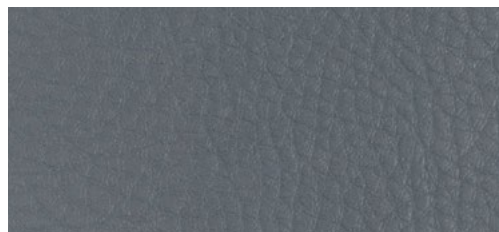

SPECIAL S 47

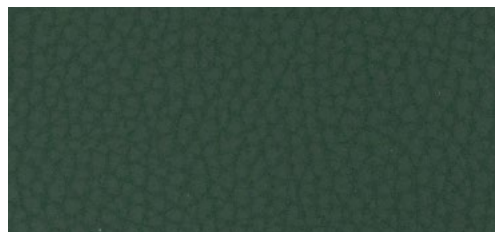

SPECIAL S 90

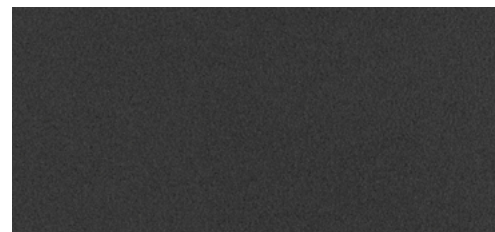

SPECIAL S A3

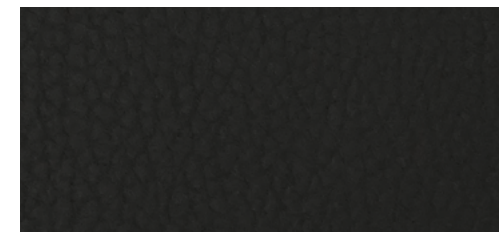

SPECIAL S 35

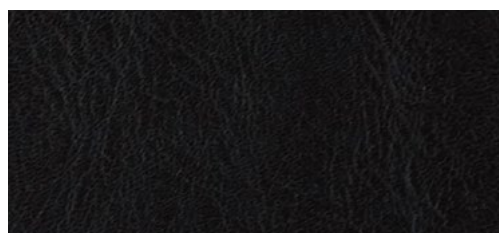

SPECIAL S 12



SPECIAL S 98

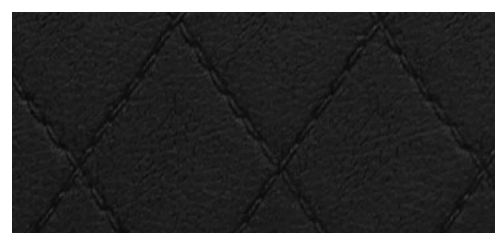

SPECIAL S 30

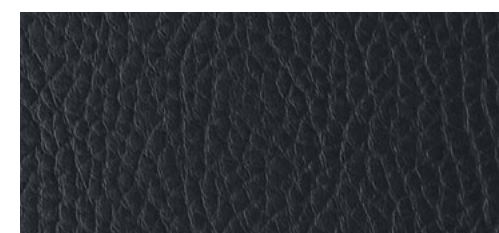

SPECIAL S 18

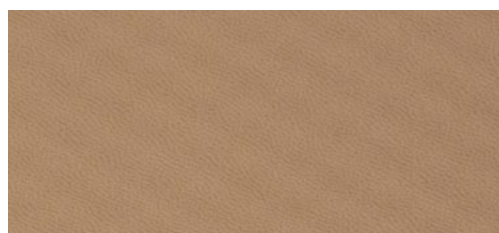

SPECIAL S 82

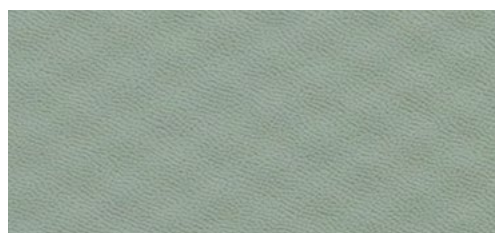

SPECIAL S 81

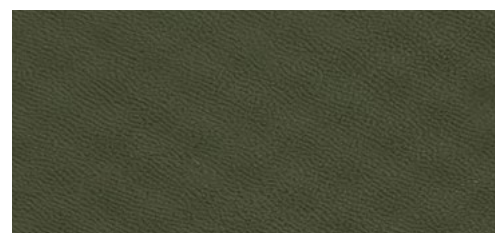

SPECIAL S 83

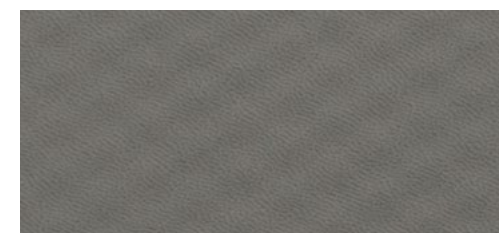

SPECIAL S 84

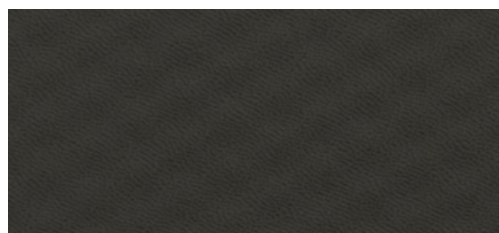

SPECIAL S 85

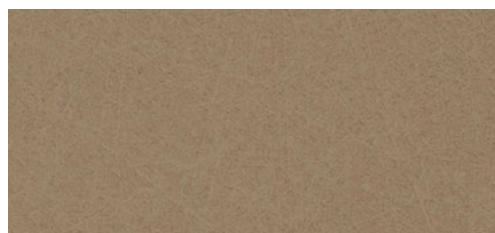

SPECIAL S 60

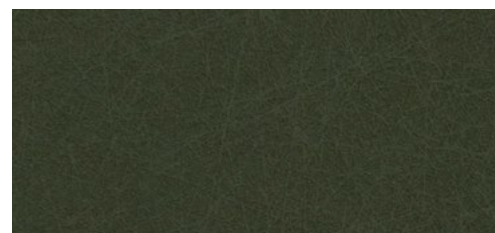

SPECIAL S 62

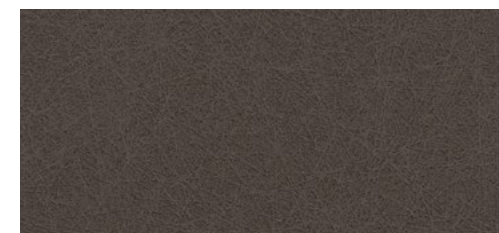

SPECIAL S 63



UE Standards
EN1021-1+2



UNI 9175: 2010



[PAG. 42 - EMBOSING/PER POLTRONE/FOR CHAIRS/
POUR FAUTEUILS/FÜR STHÜLE](#)

[PAG. 95 - EMBOSING/PER LAVAGGI/FOR WASH UNITS/
POUR BACS DE LAVAGE/FÜR WASCHANLAGEN](#)



**PULIZIA
CLEANING
NETTOYAGE
REINIGUNG**

SKAI SPECIAL

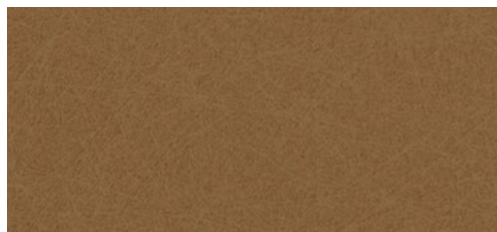

SPECIAL S 61

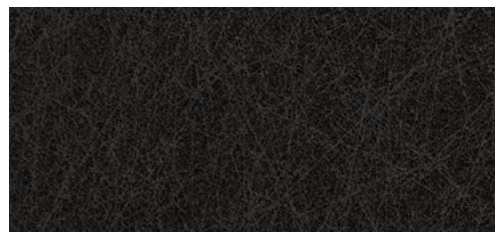

SPECIAL S 64



SPECIAL S 55

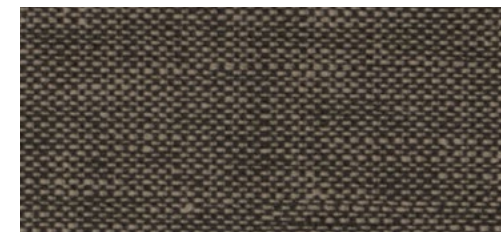

SPECIAL S 56

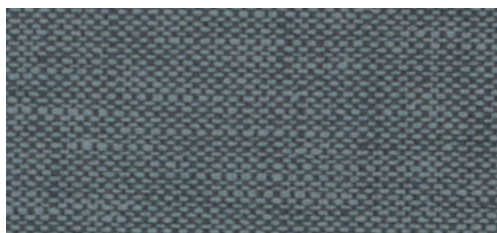

SPECIAL S 57



SPECIAL S 58



SPECIAL S 59



UE Standards
EN1021-1+2



UNI 9175: 2010

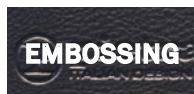

[PAG. 42 - EMBOSING/PER POLTRONE/FOR CHAIRS/
POUR FAUTEUILS/FÜR STHÜLE](#)

[PAG. 95 - EMBOSING/PER LAVAGGI/FOR WASH UNITS/
POUR BACS DE LAVAGE/FÜR WASCHANLAGEN](#)



**PULIZIA
CLEANING
NETTOYAGE
REINIGUNG**



CONDIZIONI GENERALI DI VENDITA - GENERAL SALES CONDITIONS

CONDITIONS GENERALES DE VENTE - VERKAUFSBEDINGUNGEN

ITALIANO

A) ORDINAZIONI DI MERCI E CONSEGNE DELLE STESSE

1. LE CONDIZIONI GENERALI DI VENDITA DELLA PIETRANERA S.R.L. SI INTENDONO TACITAMENTE ACCETTATE DALL'ACQUIRENTE AL MOMENTO DELLA TRASMISSIONE DELL'ORDINE.

2. GLI ORDINI VENGONO ACCETTATI SOLO SE TRASMESSI PER ISCRITTO.

3. LA DATA DI CONSEGNA È DA INTENDERSI QUALE PREVISIONE FORMULATA DALLA PIETRANERA S.R.L. SULLA BASE DELLE DISPONIBILITÀ PRODUTTIVE AL MOMENTO DELL'ORDINE STESSO. EVENTUALI NON CONFORMITÀ SULLA CONFERMA D'ORDINE DOVRANNO ESSERE COMUNICATE ENTRO 2 GIORNI DAL RICEVIMENTO DELLA STESSA.

4. EVENTUALI MODIFICHE, VARIAZIONI O ANNULLAMENTI APPORTATI DALL'ACQUIRENTE AD ORDINI GIÀ IN CORSO DI PRODUZIONE DARANNO DIRITTO ALLA PIETRANERA S.R.L. DI ADDEBITARE AL COMPRATORE LE MAGGIORI SPESE SUBITE.

5. L'IMBALLAGGIO DELLE MERCI È COMPRESO NEI PREZZI DELLA PIETRANERA S.R.L.; EVENTUALI IMBALLI SPECIALI SU RICHIESTA VERRANNO ADDEBITATI A PARTE.

6. LA MERCE SI INTENDE VENDUTA FRANCO FABBRICA REGGIO EMILIA. LA MERCE VIAGGIA SEMPRE A RISCHIO E PERICOLO DELL'ACQUIRENTE, ANCHE SE VENISSE SPEDITA FRANCO DESTINO.

RESTA ESCLUSA QUALSIASI RESPONSABILITÀ DI PIETRANERA S.R.L. PER MANCANZE, AVARIE, O QUANT'ALTRO POSSA AVVENIRE IN RELAZIONE AL TRASPORTO.

7. SE LA MERCE NON VIENE RITIRATA DALL'ACQUIRENTE ENTRO DIECI GIORNI DALLA DATA DI AVVISO DI MERCE PRONTA, PIETRANERA S.R.L. POTRÀ SENZA ALTRO AVVISO ADDEBITARE LE SPESE DI STOCCAGGIO NELLA MISURA PREVISTA DALLE TARIFFE DEI MAGAZZINI DOGANALI.

8. PER NESSUNA RAGIONE L'ACQUIRENTE PUÒ RIFIUTARSI DI RITIRARE O SVINCOLARE LA MERCE ORDINATA; QUALORA LO FACESSE, OGNI MAGGIOR ONERE INERENTE DETTO RIFIUTO RIMARRÀ A CARICO DELLA STESSA.

9. L'ACQUIRENTE HA 8 GIORNI DI TEMPO, DAL RICEVIMENTO DELLE MERCI, PER SEGNALARE ALLA PIETRANERA S.R.L. LA NON CONFORMITÀ DELLE STESSE ALL'ORDINE.

10. TUTTI I RESI DI MERCE, PER QUALSIASI TITOLO O RAGIONE, DOVRANNO ESSERE AUTORIZZATI PER ISCRITTO DALLA PIETRANERA S.R.L. ALLA DITTA ACQUIRENTE.

11. LA PIETRANERA S.R.L. È AUTORIZZATA AD APPORTARE MODIFICHE INTESE A MIGLIORARE LA FUNZIONALITÀ E L'ESTETICA DEGLI ARTICOLI SENZA AVERE L'OBBLIGO DELLA PREVENTIVA COMUNICAZIONE ALLA PARTE COMMITTENTE. I COLORI ESPOSTI SULLE COLLEZIONI DELLA PIETRANERA S.R.L. HANNO VALORE INDICATIVO E NON IMPEGNATIVO, ESSENDO POSSIBILI VARIAZIONI DI TONALITÀ PER CAUSE INDIPENDENTI DALLA VOLONTÀ DELLA PIETRANERA S.R.L.

B) GARANZIA

1. PIETRANERA S.R.L. GARANTISCE IL MATERIALE DI SUA FABBRICAZIONE PER LA DURATA DI 24 MESI. ENTRO TALE TERMINE, SI IMPEGNA ALLA SOSTITUZIONE O RIPARAZIONE DEI PEZZI CHE RISULTASSERO DIFETTOSI ALL'ORIGINE, RESI FRANCO FABBRICA REGGIO EMILIA. NEL CASO VENGA RICHIESTO L'INVIO DEI PEZZI DI RICAMBIO, LE SPESE DI TRASPORTO ED IL RISCHIO RELATIVO SARANNO A CARICO DELL'ACQUIRENTE. IN OGNI CASO, NON È COMPRESA NELLE GARANZIE LA PRESTAZIONE DI MANO D'OPERA, COSÌ COME GLI EVENTUALI DANNI SUBITI DALL'ACQUIRENTE.

2. I PEZZI DI RICAMBIO RICHIESTI DALL'ACQUIRENTE VERRANNO REGOLARMENTE FATTURATI DALLA PIETRANERA S.R.L.. L'ACQUIRENTE DOVRÀ RENDERE, A PROPRIE SPESE, I PEZZI DIFETTOSI SOSTITUIBILI ALLO STABILIMENTO DELLA PIETRANERA S.R.L.. QUESTA VERIFICHERÀ CHE ESISTANO I PRESUPPOSTI RICHIESTI AL PUNTO B.1 PER LA PRESTAZIONE DI GARANZIA ED EMETTERÀ NOTA D'ACCREDITO A FAVORE DELL'ACQUIRENTE.

C) PAGAMENTI

1. IL RITARDO DEL PAGAMENTO DELLA MERCE RISPETTO AI TERMINI PATTUITI DÀ LUOGO ALLA IMMEDIATA DECORRENZA DEGLI INTERESSI DI MORA, NELLA MISURA DEL TASSO UFFICIALE DI SCONTO AUMENTATO DI SEI PUNTI, INTENDENDOSI LE PRESENTI CONDIZIONI GENERALI DI VENDITA INTIMAZIONE SCRITTA, A NORMA DELL'ART. 1219 DEL CODICE CIVILE. LE SPESE VERRANNO ADDEBITATE IN BASE ALL'EFFETTIVO AMMONTARE PAGATO DALLA PIETRANERA S.R.L..

2. IL TERMINE O I TERMINI FISSATI A FAVORE DEL COMPRATORE PER IL PAGAMENTO DELLE MERCI SI INTENDONO DECADUTI, A NORMA DELL'ART. 1186 DEL CODICE CIVILE E RISPETTO A TUTTE LE FORNITURE ESEGUITE, NEL CASO CHE L'ACQUIRENTE NON ADEMPIA ANCHE AD UNO SOLO DEI PAGAMENTI PREVISTI. IN QUESTA IPOTESI L'ACQUIRENTE, NON APPENA RICHIESTO, DOVRÀ PROVVEDERE ALL'IMMEDIATO ADEMPIMENTO DI TUTTE LE OBBLIGAZIONI PECUNIARIE IN ESSERE CON LA PIETRANERA S.R.L., CHE SARÀ IN OGNI CASO AUTORIZZATA AD EMETTERE TRATTA A VISTA PER OGNI SUA RAGIONE DI CREDITO.

ITALIANO

D) NORME E FORO COMPETENTE

1. CONDIZIONI PARTICOLARI DI VENDITA STABILITE DI VOLTA IN VOLTA, ED IN DEROGA ALL'E SOPRA ESPOSTE CONDIZIONI GENERALI, MODIFICHERANNO SOLO I PUNTI RICHIAMATI NELLE RELATIVE PATTUZIONI, FERMI RESTANDO I RIMANENTI PUNTI.

2. LE EVENTUALI PATTUZIONI DI CUI AL PUNTO PRECEDENTE SARANNO VALIDE ED IMPEGNATIVE SOLO SE STIPULATE IN FORMA SCRITTA.

3. IN CASO DI CONTROVERSIA NELL'APPLICAZIONE DELLE "CONDIZIONI GENERALI DI VENDITA" VIENE ELETTO FORO COMPETENTE QUELLO DI REGGIO EMILIA.

E) INFORMAZIONI GENERALI

1. PER LA PULITURA DEI RIVESTIMENTI IN SKAI NON SONO NECESSARI ACCORGIMENTI PARTICOLARI. LO SPORCO NORMALE SI PULISCE SEMPLICEMENTE CON UN PANNINO UMIDO (NON BAGNATO). SI PUÒ ANCHE USARE UNA SCHIUMA A SECCO CHE SI TROVA IN COMMERCIO. NON USARE DETERGENTI ABRASIVI O SOLVENTI. I FABBRICANTI NON GARANTISCONO LA PULITURA DI MACCHIE PRODOTTE DA SOSTANZE COLORANTI CHIMICHE O ACIDE.

2. NEL CASO DI RIVESTIMENTI REALIZZATI CON MATERIALI FORNITI DAL CLIENTE, NON VERRÀ APPLICATA ALCUNA DEDUZIONE E NON ESISTONO I PRESUPPOSTI PER GARANTIRE LA QUALITÀ DI FINITURA.

3. I PARTICOLARI IN ALLUMINIO (BASI, BRACCIOLI, ECC.) NON DEBBO NO ESSERE PULITI CON PRODOTTI ABRASIVI. EVENTUALI IMPERFEZIONI DOVUTE ALLA NATURALE POROSITÀ DEL MATERIALE NON DOVRANNO ESSERE CONSIDERATI DIFETTI.

4. PER LE PARTI IN LEGNO, TRATTANDOSI DI UN MATERIALE NATURALE, INFLUISCONO SULLA COLORAZIONE FATTORI INDIPENDENTI DALLA NOSTRA VOLONTÀ, COME LE VENATURE, LA STAGIONATURA, L'INVECCHIAMENTO ED ALTRI, CHE NON CONSENTONO DI OTTENERE LA PERFETTA IDENTICITÀ DEL COLORE.

5. I COLORI DELLE ILLUSTRAZIONI DEL CATALOGO SONO INDICATIVI, IN QUANTO SUBISCONO L'EFFETTO DI OMBRE, LUCI, RIFLESSI E COMPOSIZIONI CROMATICHE IN FASE DI STAMPA.

ENGLISH

A) GOODS ORDERS AND DELIVERIES

1. THE GENERAL CONDITIONS OF SALE OF PIETRANERA SRL SHALL BE CONSIDERED TACITLY ACCEPTED BY THE PURCHASER AT THE TIME OF ORDER DISPATCH.

2. ORDERS CAN ONLY BE ACCEPTED IF MADE IN WRITING.

3. THE DATE OF DELIVERY SHALL BE CONSIDERED MADE BY PIETRANERA SRL ON THE BASIS OF PRODUCT AVAILABILITY AT THE TIME THE ORDER WAS PLACED. ANY NON CONFORMITIES IN THE ORDER CONFIRMATION MUST BE NOTIFIED WITHIN 2 DAYS AFTER THE RECEIPT OF IT.

4. ANY AMENDMENTS, CHANGES OR CANCELLATIONS MADE BY BUYERS TO ORDERS ALREADY IN PROGRESS SHALL ENTITLE PIETRANERA SRL TO CHARGE THE BUYER ANY FURTHER COSTS SUSTAINED.

5. PACKAGING OF THE GOODS IS INCLUDED IN PIETRANERA SRL PRICES; ANY SPECIAL PACKAGING ON REQUEST SHALL BE CHARGE SEPARATELY.

6. GOODS ARE SOLD EX-WORKS REGGIO EMILIA. GOOD ALWAYS TRAVEL AT THE BUYER'S RISK, INCLUDING THOSE DISPATCHED CARRIAGE FREE. PIETRANERA SRL CANNOT ACCEPT ANY LIABILITY WHATSOEVER FOR MISSING PRODUCTS, FAULTS AND ANY OTHER OCCURRENCES DURING TRANSPORT.

7. IF THE GOODS ARE NOT COLLECTED BY THE BUYER WITHIN TEN DAYS FROM THE DATE OF NOTIFICATION THAT THE GOODS ARE READY, PIETRANERA SRL SHALL BE ENTITLED, WITHOUT FURTHER NOTIFICATION, TO CHARGE STORAGE COSTS TO THE EXTENT CONTEMPLATED BY CUSTOMS WAREHOUSING TARIFFS.

8. UNDER NO CIRCUMSTANCES WHATSOEVER SHALL THE BUYER BE ENTITLED TO REFUSE COLLECTING OR CLEARING THE ORDERED GOODS; IN THE EVENT OF ITS DOING SO, ALL EXPENSES INCURRED RELATING TO SUCH REFUSAL SHALL BE BORNE BY THE BUYER.

9. THE BUYER HAS 8 DAYS FROM RECEIPT OF GOODS IN WHICH TO NOTIFY PIETRANERA SRL OF ANY NONCONFORMITY OF GOODS TO ORDER.

10. ALL RETURN OF GOODS, FOR ANY REASON WHATSOEVER, MUST BE AUTHORISED IN WRITING BY PIETRANERA SRL TO THE BUYER.

11. PIETRANERA SRL IS AUTHORISED TO MAKE CHANGES INTENDED TO UPGRADE THE FUNCTIONALITY AND AESTHETICS OF THE ARTICLES WITHOUT BEING OBLIGED TO NOTIFY THE BUYER OF SUCH CHANGES BEFOREHAND. THE COLOURS SHOWN ON PIETRANERA SRL COLLECTIONS ARE MERELY APPROXIMATE AND ARE NOT BINDING, INASMUCH AS VARIATIONS IN SHADE ARE POSSIBLE FOR REASONS BEYOND THE CONTROL OF PIETRANERA SRL.

ENGLISH

B) WARRANTY

1. MATERIALS MANUFACTURED BY PIETRANERA SRL ARE COVERED BY A 24-MONTH WARRANTY. WITHIN THIS PERIOD, THE COMPANY UNDERTAKES TO REPLACE OR REPAIR ITEMS WITH MANUFACTURING FAULTS, RETURNED CARRIAGE FREE TO REGGIO EMILIA. IN THE EVENT OF SPARE PARTS BEING REQUESTED, TRANSPORT COSTS AND RISKS SHALL BE BORNE BY THE BUYER. IN ALL CASES, THE WARRANTY DOES NOT COVER LABOUR, OR ANY DAMAGE SUFFERED BY THE BUYER.

2. SPARE PARTS REQUESTED BY THE BUYER WILL BE INVOICED BY PIETRANERA SRL ACCORDING TO NORMAL PROCEDURES. THE BUYER SHALL RETURN, AT ITS OWN EXPENSE, THE FAULTY PARTS TO BE REPLACED IN THE FACTORY OF PIETRANERA SRL. THE LATTER SHALL DETERMINE WHETHER THE WARRANTY CONDITIONS EXIST AS INDICATED AT POINT B.1 AND SHALL ISSUE A CREDIT NOTE IN FAVOUR OF THE BUYER.

C) PAYMENTS

1. DELAY IN PAYING FOR GOODS WITH RESPECT TO THE AGREED TERMS SHALL RESULT IN THE IMMEDIATE CHARGING OF INTEREST ON DELAYED PAYMENT AT THE OFFICIAL BANK RATE INCREASED BY SIX POINTS, THESE GENERAL SALES CONDITIONS BEING INTENDED AS A WRITTEN INJUNCTION IN ACCORDANCE WITH ART. 1219 OF THE CIVIL CODE. COSTS SHALL BE CHARGED ACCORDING TO THE ACTUAL AMOUNT PAID BY PIETRANERA SRL.

2. THE TERM OR TERMS LAID DOWN IN FAVOUR OF THE BUYER FOR PAYMENT OF THE GOODS SHALL BE CONSIDERED EXPIRED, IN ACCORDANCE WITH ART. 1186 OF THE CIVIL CODE AND WITH RESPECT TO ALL THE SUPPLIES MADE, IN THE EVENT OF THE BUYER FAILING TO MAKE EVEN ONE OF THE CONTEMPLATED PAYMENTS. IN THIS CASE, THE BUYER, UPON BEING REQUESTED TO DO SO, SHALL FULFIL ALL THE PECUNIARY OBLIGATIONS IN EXISTENCE WITH PIETRANERA SRL, WHICH SHALL NONETHELESS BE AUTHORISED TO ISSUE A SIGHT DRAFT FOR ALL OUTSTANDING CREDITS.

D) NORMS AND COMPETENT COURT OF LAW

1. SPECIAL SALES CONDITIONS ESTABLISHED FROM TIME TO TIME, AND BY WAY OF DEPARTURE FROM THE AFOREMENTIONED GENERAL CONDITIONS, SHALL ONLY AMEND THE SPECIFIC POINTS INDICATED IN THE RELEVANT AGREEMENTS, WITHOUT AFFECTING THE REMAINING POINTS.

2. ANY AGREEMENTS AS AT THE PREVIOUS POINT SHALL ONLY BE VALID AND BINDING IF MADE IN WRITING.

3. IN THE EVENT OF DISPUTES RELATING TO THE ENFORCEMENT OF THE "GENERAL SALES CONDITIONS" THE COMPETENT COURT OF LAW SHALL BE THAT OF REGGIO EMILIA.

E) GENERAL INFORMATION

1. TO CLEAN IMITATION LEATHER COVERS (UPHOLSTERY?), NO SPECIAL METHOD IS REQUIRED. NORMAL DIRT CAN BE REMOVED WITH A DAMP CLOTH (NOT WET). DRY-FOAM, READILY AVAILABLE ON THE MARKET, CAN ALSO BE USED. DO NOT USE ABRASIVE DETERGENTS OR SOLVENTS THE MANUFACTURERS CANNOT GUARANTEE THE REMOVAL OF STAINS CAUSED BY CHEMICAL DYES OR ACIDS.

2. IN THE CASE OF COVERINGS MADE FROM MATERIALS SUPPLIED BY THE CUSTOMER, NO DEDUCTION CAN BE MADE AND NO ASSURANCE CAN BE GIVEN OF THE FINAL QUALITY STANDARD OF THE JOB.

3. ALUMINIUM PARTS (BASES, ARMRESTS, ETC.) MUST NOT BE CLEANED USING ABRASIVE PRODUCTS. ANY IMPERFECTIONS DUE TO THE NATURAL POROSITY OF THE MATERIAL SHALL NOT BE CONSIDERED FAULTS.

4. FOR THE WOOD PARTS, BECAUSE THIS IS A NATURAL MATERIAL, THE COLOUR IS AFFECTED BY FACTORS BEYOND OUR CONTROL, SUCH AS GRAIN, SEASONING, AGEING AND OTHERS, WHICH DO NOT PERMIT ACHIEVING EXACTLY THE SAME COLOUR.

5. THE COLOURS SHOWN IN THE CATALOGUE ILLUSTRATIONS ARE APPROXIMATE, BEING SUBJECT TO SHADOW, LIGHT, REFLECTIONS AND COLOUR COMPOSITION DURING PRINTING.

FRANÇAIS

A) COMMANDES ET LIVRAISONS DE MARCHANDISES

1. LES CONDITIONS GÉNÉRALES DE VENTE DE PIETRANERA S.R.L. S'ENTENDENT TACITEMENT ACCEPTÉES PAR L'ACHETEUR AU MOMENT DE LA TRANSMISSION DE LA COMMANDE.

2. LES COMMANDES NE SONT ACCEPTÉES QUE SI ELLES SONT TRANSMISES PAR ÉCRIT.

3. LA DATE DE LIVRAISON DOIT ÊTRE CONSIDÉRÉE EN TANT QU'UNE PRÉVISION FORMULÉE PAR PIETRANERA S.R.L.. SUR LA BASE DES DISPONIBILITÉS DE PRODUCTION AU MOMENT DE LA COMMANDE MÊME. ÉVENTUELLES NON-CONFORMITÉS SUR LA CONFIRMATION DE COMMANDE DOIT ÊTRE COMMUNIQUÉES DANS LES 2 JOURS APRÈS LA RÉCEPTION DE LA MÊME.

4. D'ÉVENTUELLES MODIFICATIONS, VARIATIONS OU ANNULATIONS APPORTÉES PAR L'ACHETEUR À DES COMMANDES EN COURS DE PRODUCTION DONNERONT DROIT À PIETRANERA S.R.L. DE DÉBITER L'ACHETEUR DES PLUS GROSSES DÉPENSES SUPPORTÉES.

5. L'EMBALLAGE DES MARCHANDISES EST COMPRIS DANS LES PRIX DE PIETRANERA S.R.L.; D'ÉVENTUELLES EMBALLAGES SPÉCIAUX SUR DEMANDE SERONT DÉBITÉS À PART.

FRANÇAIS

6. LA MARCHANDISE S'ENTEND VENDUE DÉPART USINE REGGIO EMILIA. LA MARCHANDISE VOYAGE TOUJOURS AUX RISQUES ET PÉRILS DE L'ACHETEUR, MÊME SI ELLE EST ENVOYÉE FRANCO-DESTINATION. TOUTE RESPONSABILITÉ DE PIETRANERA S.R.L.. POUR FAUTES, AVARIES, OU POUR TOUT CE QUI POURRAIT ÊTRE LIÉ AU TRANSPORT, EST EXCLUE.

7. SI LA MARCHANDISE N'EST PAS RETIRÉE PAR L'ACHETEUR DANS LES DIX JOURS À COMPTER DE LA DATE D'AVIS DE MARCHANDISES DISPONIBLES, PIETRANERA S.R.L.. POURRA SANS AUCUN AUTRE AVIS DÉBITER LES DÉPENSES DE STOCKAGE DANS LA MESURE PRÉVUE PAR LES TARIFS DES ENTREPÔTS DE DOUANE.

8. POUR AUCUNE RAISON L'ACHETEUR NE PEUT SE REFUSER DE RETIRER OU DE DÉDOUANER LA MARCHANDISE COMMANDÉE; AU CAS OÙ IL LE FERAIT, TOUTE AUGMENTATION DE CHARGE RELATIVE À CE REFUS SERA À SA CHARGE.

9. L'ACHETEUR A 8 JOURS, À COMPTER DE LA RÉCEPTION DES MARCHANDISES, POUR SIGNALER À PIETRANERA S.R.L.. LA NON-CONFORMITÉ DE CES DERNIÈRES À LA COMMANDE.

10. TOUTS LES RENDUS DE MARCHANDISE, POUR QUELQUE TITRE OU MOTIF QUE CE SOIT, DEVRONT ÊTRE AUTORISÉS PAR ÉCRIT PAR PIETRANERA S.R.L. À L'ENTREPRISE ACHÉTEUSE.

11. PIETRANERA S.R.L.. EST AUTORISÉE À APPORTER DES MODIFICATIONS DESTINÉES À AMÉLIORER LE BON FONCTIONNEMENT ET L'ESTHÉTIQUE DES ARTICLES SANS AVOIR L'OBLIGATION D'EN INFORMER PRÉALABLEMENT LE COMMETTANT. LES COLORIS EXPOSÉS SUR LES COLLECTIONS DE PIETRANERA S.R.L.. ONT UNE VALEUR INDICATIVE ET NON DÉFINITIVE, ÉTANT DONNÉ QU'IL POURRAIT Y AVOIR DES VARIATIONS DE TONALITÉS POUR DES CAUSES INDÉPENDANTES DE LA VOLONTÉ DE PIETRANERA S.R.L..

B) GARANTIE

1. PIETRANERA S.R.L.. GARANTIT LE MATÉRIEL DE SA FABRICATION POUR LA DURÉE DE 24 MOIS. AVANT CE DÉLAI, ELLE S'ENGAGE À REMPLACER OU À RÉPARER DES PIÈCES QUI SERAIENT DÉFECTUEUSES À L'ORIGINE, RENDUES EN FRANCO DE PORT À REGGIO EMILIA. AU CAS OÙ L'ON DEMANDERAIT L'ENVOI DES PIÈCES DE RECHANGE, LES DÉPENSES DE TRANSPORT ET LE RISQUE Y AFFÉRENT SERONT À LA CHARGE DE L'ACHETEUR. DE TOUTE FAÇON, LA PRESTATION DE MAIN-D'ŒUVRE AINSI QUE LES ÉVENTUELS DOMMAGES SÛBIS PAR L'ACHETEUR NE SONT PAS COMPRIS DANS LES GARANTIES.

2. LES PIÈCES DE RECHANGE DEMANDÉES PAR L'ACHETEUR SERONT RÉGULIÈREMENT FACTURÉES PAR PIETRANERA S.R.L.. L'ACHETEUR DEVRA RENDRE, À SES FRAIS, LES PIÈCES DÉFECTUEUSES REMPLAÇABLES À L'USINE DE PIETRANERA S.R.L.. CETTE DERNIÈRE CONTRÔLERA L'EXISTENCE DES CONDITIONS DEMANDÉES AU POINT B.1 POUR LA PRESTATION DE GARANTIE ET ÉTABLIRA UNE FACTURE D'AVOIR EN FAVEUR DE L'ACHETEUR.

C) PAIEMENTS

1. LE RETARD DU PAIEMENT DE LA MARCHANDISE PAR RAPPORT AUX DÉLAIS STIPULÉS DONNE LIEU AU VERSEMENT IMMÉDIAT DES INTÉRÊTS MORATOIRES, DANS LA MESURE DU TAUX D'ESCOMPTE OFFICIEL MAJORÉ DE SIX POINTS, LES PRÉSENTES CONDITIONS GÉNÉRALES DE VENTE DEVANT ÊTRE CONSIDÉRÉES EN TANT QUE SOMMATION ÉCRITE, CONFORMÉMENT À L'ART. 1219 DU CODE CIVIL. LES DÉPENSES SERONT DÉBITÉES SELON LE MONTANT EFFECTIF PAYÉ PAR PIETRANERA.

2. LE OU LES DÉLAIS FIXÉS EN FAVEUR DE L'ACHETEUR POUR LE PAIEMENT DES MARCHANDISES S'ENTENDENT ÉCHUS, CONFORMÉMENT À L'ART. 1186 DU CODE CIVIL ET PAR RAPPORT À TOUTES LES FOURNITURES RÉALISÉES, AU CAS OÙ L'ACHETEUR N'EFFECTUERAIT PAS NE SERAIT-CE QU'UN DES PAIEMENTS PRÉVUS. DANS CETTE HYPOTHÈSE L'ACHETEUR DEVRA, DÈS QUE CELA LUI SERA DEMANDÉ, SE CHARGER DE SATISFAIRE IMMÉDIATEMENT TOUTES LES OBLIGATIONS PÉCUNIAIRES EN COURS AVEC PIETRANERA S.R.L., LAQUELLE SERA DE TOUTE FAÇON AUTORISÉE À ÉMETTRE UN EFFET À VUE POUR CHACUNE DES RAISONS DE CRÉDIT.

D) NORMES ET TRIBUNAL COMPÉTENT

1. DES CONDITIONS DE VENTE PARTICULIÈRES ÉTABLIES AU FUR ET À MESURE, ET PAR DÉROGATION AUX CONDITIONS GÉNÉRALES SUSMENTIONNÉES, NE MODIFIERONT QUE LES POINTS RENVOYANT AUX STIPULATIONS CORRESPONDANTES, LES AUTRES POINTS RESTANT INCHANGÉS.

2. LES ÉVENTUELLES STIPULATIONS VISÉES AU POINT PRÉCÉDENT NE SERONT VALABLES ET DÉFINITIVES QUE SI ELLES SONT STIPULÉES PAR ÉCRIT.

3. EN CAS DE CONFLIT DANS L'APPLICATION DES « CONDITIONS GÉNÉRALES DE VENTE » LE TRIBUNAL COMPÉTENT EST CELUI DE REGGIO EMILIA.

E) INFORMATIONS GÉNÉRALES

FRANÇAIS

1. POUR LE NETTOYAGE DES REVÊTEMENTS EN SKAI AUCUNE PRÉCAUTION PARTICULIÈRE N'EST NÉCESSAIRE. LA SALETÉ NORMALE SE NETTOIE SIMPLEMENT À L'AIDE D'UN CHIFFON HUMIDE (NON MOUILLÉ). ON PEUT ÉGALEMENT UTILISER UNE MOUSSE SÈCHE QUE L'ON TROUVE DANS LE COMMERCE. NE PAS UTILISER DE NETTOYANTS ABRASIFS OU DES SOLVANTS. LES FABRICANTS NE GARANTISSENT PAS LE NETTOYAGE DE TACHES PRODUITES PAR DES SUBSTANCES COLORANTES CHIMIQUES OU ACIDES.
2. DANS LE CAS DE REVÊTEMENTS RÉALISÉS AVEC DES MATÉRIAUX FOURNIS PAR LE CLIENT, AUCUNE RÉDUCTION NE SERA APPLIQUÉE ET LES CONDITIONS POUR GARANTIR LA QUALITÉ DE FINISSAGE N'EXISTENT PAS.
3. LES DÉTAILS EN ALUMINIUM (BASES, ACCOUDOIRS, ETC.) NE DOIVENT PAS ÊTRE NETTOYÉS AVEC DES PRODUITS ABRASIFS. D'ÉVENTUELLES IMPERFECTIONS DUES À LA POROSITÉ NATURELLE DU MATÉRIAU NE DEVRONT PAS ÊTRE CONSIDÉRÉES COMME DES DÉFAUTS.
4. POUR LES PARTIES EN BOIS, ÉTANT DONNÉ QU'IL S'AGIT D'UN MATÉRIAU NATUREL, DES FACTEURS INDÉPENDANTS DE NOTRE VOLONTÉ INFLUENT SUR LA COLORATION TELS QUE LES INURES, LE SÉCHAGE, LE VIEILLISSEMENT ET AUTRES, LESQUELS NE PERMETTENT PAS D'OBTENIR UNE COULEUR PARFAITEMENT IDENTIQUE.
5. LES COULEURS DES ILLUSTRATIONS DU CATALOGUE NE SONT CITÉES QU'À TITRE INDICATIF, ÉTANT DONNÉ QU'ELLES SUBISSENT L'EFFET D'OMBRES, DE LUMIÈRES, DE REFLETS ET DE COMPOSITIONS CHROMATIQUES DURANT L'IMPRESSION.

DEUTSCH

A) WARENBESTELLUNG UND-LIEFERUNG

1. DIE ALLGEMEINEN VERKAUFSBEDINGUNGEN DER PIETRANERA S.R.L. VERSTEHEN SICH ZUM ZEITPUNKT DER AUFTRAGSÜBERMITTLUNG VOM KÄUFER BEDINGUNGSLOS AKZEPTIERT.
2. DIE AUFTRÄGE WERDEN NUR AKZEPTIERT, WENN SIE UNS SCHRIFTLICH ERREICHEN.
3. DAS LIEFERDATUM VERSTEHT SICH ALS VON PIETRANERA S.R.L. ERSTELLTE VORAUSGABE, AUFGRUND DER PRODUKTIONSBEREITSCHAFT ZUM ZEITPUNKT DER AUFTRAGSSTELLUNG.
4. EVENTUELLE ABÄNDERUNGEN, VARIATIONEN ODER STREICHUNGEN SEITENS DES KÄUFERS VON SICH BEREITS IN DER PRODUKTION BEFINDENDEM MATERIAL, BERECHTIGEN PIETRANERA S.R.L. DAZU, DEM KÄUFER DIE HAUPTSPESEN ANZULASTEN.
5. DIE VERPACKUNG DER WARE IST IM PREIS DER PIETRANERA S.R.L. INBEGRIFFEN; EVENTUELLE SPEZIALVERPACKUNGEN AUF ANFRAGE WERDEN SEPARAT BERECHNET.
6. DIE WARE VERSTEHT SICH FREI AB WERK REGGIO EMILIA VERKAUFT. DAS RISIKO BZW. DIE GEFAHR WÄHREND DES WEGES HAT STETS DER KÄUFER ZU ÜBERNEHMEN, AUCH BEI VERSAND FREI ZIELORT. FÜR UNVOLLKOMMENHEIT, PANNEN, ODER WAS AUCH IMMER IN VERBINDUNG MIT DEM TRANSPORT GESCHÉHEN KANN, ÜBERNIMMT PIETRANERA S.R.L. KEINERLEI HAFTUNG.
7. WIRD DIE WARE INNERHALB VON 10 TAGEN AB DEM HINWEIS AUF LIEFERBEREITSCHAFT NICHT VOM KÄUFER ABGEHOLT, KANN PIETRANERA S.R.L. OHNE WEITEREN HINWEIS DIE LAGERGEBÜHREN ENTSPRECHEND DES UMFANGS IN VERBINDUNG MIT DEN TARIFEN DER ZOLLAGER BELASTEN.
8. AUS KEINERLEI GRUND KANN DER KÄUFER DIE ABHOLUNG ABLEHNEN ODER DIE BESTELLTE WARE AUFHALTEN; SOLLTE ER DIES TUN, WIRD JEDLICHE ZUSÄTZLICHE BELASTUNG IN VERBINDUNG MIT DIESER ABLEHNUNG ZU SEINEN LASTEN GEHEN.
9. DER KÄUFER HAT 8 TAGE ZEIT, AB DEM WARENERHALT, UM PIETRANERA S.R.L. ÜBER DIE NICHTÜBEREINSTIMMUNG DER WARE MIT DER BESTELLUNG ZU INFORMIEREN.
10. ALLE WARENRÜCKSENDUNGEN, GANZ GLEICH AUS WELCHER VERANLASSUNG ODER AUS WELCHEM GRUND, MÜSSEN DEM KÄUFER SCHRIFTLICH VON PIETRANERA GENEHMIGT WERDEN.
11. PIETRANERA S.R.L. IST DAZU BEFÄHIGT, ÄNDERUNGEN ZWECKS VERBESSERUNG DER BETRIEBSFÄHIGKEIT UND DES ÄUSSEREN ERSCHEINENS DER ARTIKEL VORZUNEHMEN, OHNE VERPFLICHTET ZU SEIN, DEN AUFTRAGGEBER VORZEITIG HIERÜBER ZU INFORMIEREN. DIE FARBEN DER VON PIETRANERA S.R.L. VORGESTELLTEN KOLLEKTIONEN VERSTEHEN SICH ALS ANNÄHERND UND NICHT ALS BINDEND, DA ES ZU AUSSERHALB DER WILLENSKRAFT VON PIETRANERA S.R.L. STEHENDEN FARBTONABWEICHUNGEN KOMMEN KANN.

B) GARANTIE

C) ZAHLUNGEN

D) REGELUNGEN UND ZUSTÄNDIGER GERICHTSSTAND

E) ALLGEMEINE HINWEISE

DEUTSCH

1. PIETRANERA S.R.L. GARANTIERT DAS VON IHR HERGESTELLTE MATERIAL FÜR DIE DAUER VON 24 MONATEN. INNERHALB DIESER ZEITSPANNE VERPFLICHTET SIE SICH ZUM ERSATZ ODER ZUR REPARATUR DER TEILE, DIE SICH ALS VOM URSPRUNG HER DEFECT ERWIESEN, FREI HANS REGGIO EMILIA. SOLLTE DIE VERSENDUNG VON ERSATZTEILEN GEWÜNSCHT WERDEN, GEHEN DIE TRANSPORTKOSTEN UND DAS ENTSPRECHENDE RISIKO ZU LASTEN DES KÄUFERS. IN JEDEM FALL, NICHT VON DER GARANTIE BETROFFEN IST DIE ARBEITSKRAFT, WIE AUCH EVENTUELLE VOM KÄUFER ERLITTENE SCHÄDEN.
2. DIE VOM KÄUFER GEWÜNSCHTEN ERSATZTEILE WERDEN NORMAL VON PIETRANERA S.R.L. IN RECHNUNG GESTELLT. DER KÄUFER HAT FÜR DIE RÜCKSENDUNG DER BESCHÄDIGTEN, ZU ERSETZENDEN TEILE AN PIETRANERA S.R.L. AUFZUKOMMEN. DIESE ÜBERPRÜFT NUN, OB DIE IN PUNKT B.I VERLANGTEN BEDINGUNGEN FÜR DIE GARANTIELEISTUNG VORLIEGEN UND STELLT EINE GUTSCHRIFT ZU GUNSTEN DES KÄUFERS AUS.
1. DIE ZAHLUNGSVERZÖGERUNG DER AUSGESTELLTEN WARE GEGENÜBER DES VERREINBARTEN TERMINS, VERANLASST UMGEHEND DEN ANLAUF VON VERZÖGERUNGSZINSEN, ENTSPRECHEND DEM OFFIZIELLEN SATZ DES RABATTS, VERMEHRT UM SECHS PUNKTE, WÄHREND SICH DIE VORLIEGENDEN ALLGEMEINEN VERKAUFSBEDINGUNGEN ALS SCHRIFTLICHE AUFFORDERUNG ENTSPRECHEND ARTIKEL 1219 DES BÜRGERLICHEN GESETZBUCHS VERSTEHEN. DIE GEBÜHREN WERDEN GEMÄSS DER TATSÄCHLICHEN, VON PIETRANERA S.PA. GEZAHLTEN SUMME ANGELASTET.
2. DER TERMIN ODER DIE TERMINE, DIE ZU GUNSTEN DES KÄUFERS FÜR DIE ZAHLUNG DER WAREN FESTGESETZT WURDEN, VERSTEHEN SICH ALS VERFALLEN, LAUT ART. 1186 DES BÜRGERLICHEN GESETZBUCHES UND FÜR ALLE FOLGENDEN LIEFERUNGEN, FALLS DER KÄUFER AUCH NUR EINE DER VORGESEHENEN ZAHLUNGEN NICHT EINHALT. IN DIESEM FALL HAT DER KÄUFER, SOBALD ER AUFGERUFEN WIRD, FÜR DIE UMGEHENDE ERFÜLLUNG ALLER VERPFLICHTUNGEN GEGENÜBER PIETRANERA S.PA. ZU SORGEN, DIE IN JEDEM FALL BERECHTIGT SEIN WIRD, EINEN SICHTWECHSEL FÜR JEDEN KREDIT IHRERSEITS AUSZUSTELLEN.
1. BESONDERE VERKAUFSBEDINGUNGEN, VON MAL ZU MAL FESTGESETZT, UND IN ABWEICHUNG MIT DEN O.A, ALLGEMEINEN BEDINGUNGEN, ÄNDERN LEDIGLICH DIE IN DEN ENTSPRECHENDEN ABMACHUNGEN GENANNTEN PUNKTE AB, WÄHREND DIE ANDEREN PUNKTE BESTEHEN BLEIBEN.
2. DIE EVENTUELLEN ABMACHUNGEN DES VORHERIGEN PUNKTS, SIND NUR GÜLTIG UND VERPFLICHTEND, WENN SIE SCHRIFTLICH ERSTELLT WURDEN.
3. IM FALL VON UNSTIMMIGKEITEN BEI DER ANWENDUNG DER "ALLGEMEINEN VERKAUFSBEDINGUNGEN" GILT REGGIO EMILIAS ALS GERICHTSSTAND.
1. FÜR DIE REINIGUNG DER SKAI-BEZÜGE SIND KEINE BESONDEREN HINWEISE ZU BEACHTEN. NORMALE VERSCHMUTZUNGEN WERDEN MIT EINEM FEUCHTEN (NICHT NASSEN) TUCH ENTFERNT. ES KANN AUCH EIN IM HANDEL ERHÄLTLICHER TROCKENSCHAUM VERWENDET WERDEN. KEINE SCHEUER- ODER LÖSUNGSMITTEL VERWENDEN. DER HERSTELLER GARANTIERT NICHT FÜR DIE ENTFERNUNG VON FLECKEN, DIE DURCH CHEMISCHE ODER SAUREHALTIGE FÄRBMITTEL ENTSTANDEN SIND.
2. BEI BEZÜGEN, DIE MIT VOM KUNDEN BEIGESTELTEM MATERIAL GEFERTIGT WERDEN, WIRD KEINE PREISMINDERUNG BERECHNET; ES ENTFALLEN DIE VORAUSSETZUNGEN FÜR EINE QUALITÄTSGARANTIE DER FERTIGBEARBEITUNG.
3. TEILE IN ALUMINIUM (STANDFLÄCHEN, ARMLEHNEN USW.) DÜRFEN NICHT MIT SCHEUERMITTELN GEREINIGT WERDEN. EVENTUELLE UNREINHEITEN SIND AUF DIE NATÜRLICHE POROSITÄT DES MATERIALS ZURÜCKZUFÜHREN UND STELLEN KEINE HERSTELLUNGSFEHLER DAR.
4. DA ES SICH BEI DEN AUS HOLZ GEFERTIGTEN TEILEN UM EIN NATÜRLICHES MATERIAL HANDELT, WIRD DIE FARBTONALITÄT DURCH FAKTOREN WIE MASERUNG, ABLAGERUNG USW. BEEINFLUSST, DIE WIR NICHT STEUERN KÖNNEN UND INFOLGE DERER EINE PERFEKTE ÜBEREINSTIMMUNG DES FARBTONS NICHT MÖGLICH IST.
5. DIE AUF DEN ABBILDUNGEN ERSCHEINENDEN FARBTÖNE HABEN NUR HINWEISCHARAKTER, DA SIE BEIM DRUCK UNTERSCHIEDLICHEN DURCH SCHATTEN, LICHT, REFLEXE UND FARBKOMPOSITIONEN VERURSACHTEN EFFEKTE UNTERLIEGEN.



I DISTRIBUTORI PIETRANERA AL TUO SERVIZIO

Nel cammino verso il tuo nuovo salone dei sogni sarai affiancato da un professionista specializzato in saloni di acconciatura che ti guiderà dall'inizio alla fine..

CONSULENZE IN SHOWROOM

Per osservare direttamente materiali, funzionalità e design made in Italy

PROGETTAZIONE

Per mettere nero su bianco le tue idee e trovare la soluzione per ogni esigenza.

PIANTA 2D E RENDER 3D

Per vedere in anteprima una simulazione realistica del tuo futuro salone.

ASSISTENZA POST-VENDITA

Per non farti mai mancare la sicurezza di un supporto e un consiglio tecnico, così come ricambi ed assistenza.

PIETRANERA DISTRIBUTORS AT YOUR SERVICE

On the way to your new dream salon you will be accompanied by a professional specialized in hair salons who will guide you from the beginning to the end.

CONSULTANCY IN SHOWROOM

To observe made in Italy materials, functionality and design directly.

DESIGN

To put your ideas on paper and find the solution for every need.

2D DRAWING AND 3D RENDER

To preview a realistic simulation of your future salon.

POST-SALE SERVICE

To ensure you never lack a secure support and technical advice, as well as spare parts and service

LES DISTRIBUTEURS PIETRANERA À VOTRE SERVICE

Au cours de la réalisation du salon de vos rêves, vous serez accompagné d'un professionnel spécialisé en salons de coiffure, qui vous guidera du début à la fin.

CONSEILS EN SALLE D'EXPOSITION

Pour observer directement les matériaux, fonctionnalités et le design italiens.

CONCEPTION

Pour mettre noir sur blanc vos idées et trouver la solution pour chaque exigence.

PLAN 2D ET MAQUETTE 3D

Pour voir en avant-première une simulation réaliste de votre futur salon.

SERVICE APRÈS-VENTE

Pour compter sur l'assurance d'un support et d'un conseil technique, mais aussi sur des pièces de rechange et de l'assistance.

PIETRANERA-HÄNDLER IN IHREM DIENSTE

Auf dem Weg zu Ihrem neuen Traumsalon werden Sie von einem professionellen Friseur begleitet, der Sie bis zur Fertigstellung Ihres Salons betreut.
>BERATUNG IN DER AUSSTELLUNG

Zur direkten Besichtigung von Materialien, Funktionalität und Design Made in Italy.

PLANUNG

Um Ihre Ideen zu Papier bringen und um für jeden Bedarf die Lösung zu finden.

2D-GRUNDRISS UND 3D-RENDERING

Zur Vorschau einer realistischen Simulation Ihres zukünftigen Salons.



GARANZIA

Pietranera è da sempre sinonimo di qualità: prodotti realizzati con cura, esperienza e passione, per accompagnare l'acconciatore nel lavoro quotidiano nel tempo. Tutti i prodotti Pietranera sono garantiti in caso di difetti meccanici e di lavorazione per un periodo di due anni.

GUARANTEE

Pietranera has always stood for quality: products made with care, experience and passion, to accompany hairdressers in their daily work over time. All Pietranera products are guaranteed against mechanical and manufacturing defects for a period of two years

GARANTIE

Pietranera est depuis toujours synonyme de qualité : des produits réalisés avec soin, expérience et passion, pour accompagner le coiffeur dans son travail quotidien au fil du temps. Tous les produits Pietranera sont garantis en cas de défauts mécaniques et de façonnage, pour une période de deux ans.

GARANTIE

Pietranera ist seit jeher ein Synonym für Qualität: Produkte, die mit Sorgfalt, Erfahrung und Leidenschaft hergestellt werden, um den Friseur bei seiner täglichen Arbeit im Laufe der Zeit zu begleiten. Für alle Pietranera-Produkte wird eine Garantie von zwei Jahren auf mechanische und Herstellungsfehler gewährt





PIETRANERA SRL
VIA MASACCIO, 2 / Z.I MANCASALE / 42124 REGGIO EMILIA
T. 0522 237011 / F. 0522 514669 / INFO@PIETRANERA.COM
WWW.PIETRANERA.COM



PIETRANERA_OFFICIAL



PIETRANERAOFFICIAL



MADE IN ITALY

REV. 01/25

- valido dal.....01.05.2025
- valid from.....01.05.2025
- valide depuis le....01.05.2025
- gültig seit.....01.05.2025